

PAPER

## Progress in the ITER neutral beam test facility

To cite this article: V. Toigo *et al* 2019 *Nucl. Fusion* **59** 086058

View the [article online](#) for updates and enhancements.

### Recent citations

- [Final design of electrostatic probes for MITICA beam line components](#)  
Silvia Spagnolo *et al*
- [Negative ion beam extraction in volume mode on the RF negative ion source at ASIPP](#)  
Qinglong Cui *et al*
- [Manufacturing, Installation, and Commissioning of the Residual Ion Dump Power Supply for MITICA Experiment](#)  
Alberto Ferro *et al*



**IOP | ebooks™**

Bringing together innovative digital publishing with leading authors from the global scientific community.

Start exploring the collection—download the first chapter of every title for free.

# Progress in the ITER neutral beam test facility

V. Toigo<sup>1</sup>, S. Dal Bello<sup>1</sup>, M. Bigi<sup>1</sup>, M. Boldrin<sup>1</sup>, G. Chitarin<sup>1</sup>, L. Grando<sup>1</sup>, A. Luchetta<sup>1</sup>, D. Marcuzzi<sup>1</sup>, R. Pasqualotto<sup>1</sup>, N. Pomaro<sup>1</sup>, G. Serianni<sup>1</sup>, P. Zaccaria<sup>1</sup>, L. Zanotto<sup>1</sup>, P. Agostinetti<sup>1</sup>, M. Agostini<sup>1</sup>, V. Antoni<sup>1</sup>, D. Aprile<sup>1</sup>, M. Barbisan<sup>1</sup>, M. Battistella<sup>1</sup>, M. Brombin<sup>1</sup>, R. Cavazzana<sup>1</sup>, M. Dalla Palma<sup>1</sup>, M. Dan<sup>1</sup>, S. Denizeau<sup>1</sup>, A. De Lorenzi<sup>1</sup>, R. Delogu<sup>1</sup>, M. De Muri<sup>1</sup>, M. Fadone<sup>1</sup>, F. Fellin<sup>1</sup>, A. Ferro<sup>1</sup>, A. Fiorentin<sup>1</sup>, E. Gaio<sup>1</sup>, G. Gambetta<sup>1</sup>, F. Gasparini<sup>1</sup>, F. Gnesotto<sup>1</sup>, P. Jain<sup>1</sup>, A. Maistrello<sup>1</sup>, G. Manduchi<sup>1</sup>, S. Manfrin<sup>1</sup>, G. Marchiori<sup>1</sup>, N. Marconato<sup>1</sup>, M. Moresco<sup>1</sup>, E. Ocello<sup>1</sup>, T. Patton<sup>1</sup>, M. Pavei<sup>1</sup>, S. Peruzzo<sup>1</sup>, N. Pilan<sup>1</sup>, A. Pimazzoni<sup>1</sup>, R. Piovan<sup>1</sup>, C. Poggi<sup>1</sup>, M. Recchia<sup>1</sup>, A. Rizzolo<sup>1</sup>, G. Rostagni<sup>1</sup>, E. Sartori<sup>1</sup>, M. Siragusa<sup>1</sup>, P. Sonato<sup>1</sup>, A. Sottocornola<sup>1</sup>, E. Spada<sup>1</sup>, S. Spagnolo<sup>1</sup>, M. Spolaore<sup>1</sup>, C. Taliercio<sup>1</sup>, P. Tinti<sup>1</sup>, M. Ugoletti<sup>1</sup>, M. Valente<sup>1</sup>, A. Zamengo<sup>1</sup>, B. Zaniol<sup>1</sup>, M. Zaupa<sup>1</sup>, D. Boilson<sup>2</sup>, C. Rotti<sup>2</sup>, P. Veltri<sup>2</sup>, J. Chareyre<sup>2</sup>, H. Decamps<sup>2</sup>, M. Dremel<sup>2</sup>, J. Graceffa<sup>2</sup>, F. Geli<sup>2</sup>, B. Schunke<sup>2</sup>, L. Svensson<sup>2</sup>, M. Urbani<sup>2</sup>, T. Bonicelli<sup>3</sup>, G. Agarici<sup>3</sup>, A. Garbuglia<sup>3</sup>, A. Masiello<sup>3</sup>, F. Paolucci<sup>3</sup>, M. Simon<sup>3</sup>, L. Bailly-Maitre<sup>3</sup>, E. Bragulat<sup>3</sup>, G. Gomez<sup>3</sup>, D. Gutierrez<sup>3</sup>, C. Labate<sup>3</sup>, G. Mico<sup>3</sup>, J.F. Moreno<sup>3</sup>, V. Pilard<sup>3</sup>, G. Kouzmenko<sup>3</sup>, A. Rousseau<sup>3</sup>, M. Kashiwagi<sup>4</sup>, H. Tobari<sup>4</sup>, K. Watanabe<sup>4</sup>, T. Maejima<sup>4</sup>, A. Kojima<sup>4</sup>, N. Umeda<sup>4</sup>, S. Sasaki<sup>4</sup>, A. Chakraborty<sup>5</sup>, U. Baruah<sup>5</sup>, H. Patel<sup>5</sup>, N.P. Singh<sup>5</sup>, A. Patel<sup>5</sup>, H. Dhola<sup>5</sup>, B. Raval<sup>5</sup>, V. Gupta<sup>5</sup>, U. Fantz<sup>6</sup>, B. Heinemann<sup>6</sup>, W. Kraus<sup>6</sup>, M. Cavenago<sup>7</sup>, S. Hanke<sup>8</sup>, S. Ochoa<sup>8</sup>, P. Blatchford<sup>9</sup>, B. Chuilon<sup>9</sup>, Y. Xue<sup>9</sup>, G. Croci<sup>10</sup>, G. Gorini<sup>10</sup>, A. Muraro<sup>11</sup>, M. Rebai<sup>11</sup>, M. Tardocchi<sup>11</sup>, M. D'Arienzo<sup>12</sup>, S. Sandri<sup>13</sup>, A. Tonti<sup>14</sup> and F. Panin<sup>15</sup>

<sup>1</sup> Consorzio RFX, Corso Stati Uniti 4, 35127 Padova, Italy

<sup>2</sup> ITER Organization, Route de Vinon sur Verdon, CS 90 046, 13067 St Paul Lez Durance Cedex, France

<sup>3</sup> Fusion for Energy, C/o Josep Pla 2, 08019 Barcelona, Spain

<sup>4</sup> National Institutes for Quantum and Radiological Science and Technology, 801-1 Mukoyama, Naka, Ibaraki 311-0193, Japan

<sup>5</sup> ITER-INDIA, Institute for Plasma Research, Nr. Indira Bridge, Bhat Village, Gandhinagar, 382428, India

<sup>6</sup> Max-Planck-Institut für Plasmaphysik, Boltzmannstr. 2, 85748 Garching, Germany

<sup>7</sup> INFN-LNL, Viale dell'Università n. 2, 35020 Legnaro, Italy

<sup>8</sup> KIT, Institute for Technical Physics, Eggenstein-Leopoldshafen, Germany

<sup>9</sup> CCFE, Culham Science Centre, Oxfordshire, United Kingdom of Great Britain and Northern Ireland

<sup>10</sup> Dipartimento di Fisica 'G. Occhialini', Università di Milano-Bicocca, Milano, Italy

<sup>11</sup> Istituto di Fisica del Plasma 'P. Caldirola', Milano, Italy

<sup>12</sup> ENEA, National Institute of Ionizing Radiation Metrology, C.R. Casaccia, S.Maria di Galeria, Italy

<sup>13</sup> ENEA Radiation Protection Institute, Frascati (Roma), Italy

<sup>14</sup> INAIL-DIT, Via Ferruzzi, 40-00143 Roma, Italy

<sup>15</sup> INAIL-UOT Padova, Via Nancy, 2-35131, Padova, Italy

E-mail: [vanni.toigo@igi.cnr.it](mailto:vanni.toigo@igi.cnr.it)

Received 7 February 2019, revised 6 May 2019

Accepted for publication 17 May 2019

Published 9 July 2019



## Abstract

Heating neutral beam (HNB) injectors, necessary to achieve burning conditions and to control plasma instabilities in ITER, are characterized by such demanding parameters that a neutral beam test facility (NBTF) dedicated to their development and optimization is being realized in Padua (Italy) with direct contributions from the Italian government (through Consorzio RFX as the host entity) and the ITER international organization (with kind contributions from the ITER domestic agencies of Europe, Japan and India) and technical and scientific support from various European laboratories and universities. The NBTF hosts two experiments: SPIDER, devoted to ion source optimization for the required source performance, and MITICA, the full-size prototype of the ITER HNB, with an ion source identical to SPIDER.

This paper gives an overview of the progress towards NBTF realization, with particular emphasis on issues discovered during this phase of activity and on solutions adopted to minimize the impact on the schedule and maintain the goals of the facilities. The realization of MITICA is well advanced; operation is expected to start in 2023 due to the long procurement time of the in-vessel mechanical components. The beam source power supplies, operating at 1 MV, are in an advanced phase of realization; all high-voltage components have been installed and the complex insulation test phase began in 2018. At the same time, construction and installation of SPIDER plant systems was successfully completed with their integration into the facility. The mechanical components of the SPIDER ion source were installed inside the vessel and connected to the plants. Integrated commissioning with the control, protection and safety systems ended positively and the first experimental phase has begun. The first results of the SPIDER experiment, with data from operational diagnostics, and the plans for the 1 MV insulation tests on the MITICA high-voltage components are presented.

Keywords: ITER, neutral beam injector, PRIMA: the ITER neutral beam test facility (NBTF), SPIDER

(Some figures may appear in colour only in the online journal)

## 1. Introduction

The ITER heating neutral beam (HNB) injectors, one of the tools necessary for both the achievement of burning conditions and the control of plasma instabilities [1], are characterized by demanding parameters that have never been simultaneously achieved experimentally, such as 1 MeV particle energy, 40 A beam current over an extraction area of 0.2 m<sup>2</sup> and long pulse operation up to 3600s [2]. The development and optimization of a HNB injector capable of such performance called for the construction of a dedicated test facility [3]. This neutral beam test facility (NBTF) [4] is in an advanced state of realization in Padua (Italy), with direct contributions from the Italian government, through Consorzio RFX as the host entity, the ITER organization (IO), in-kind contributions from European, Japanese and Indian domestic agencies (DAs) and the technical and scientific support of various European laboratories and universities. The NBTF hosts two experiments, SPIDER [5] and MITICA [6]. The former is devoted to the optimization of the HNB and diagnostic neutral beam (DNB) ion sources and to the achievement of the required source performances. Both

are based on the RF negative ion source concept developed at IPP (Garching) [7]. MITICA is the full size prototype of the ITER HNB, with an ion source design close to that used in SPIDER, but with modifications in view of its integration with the 1 MV accelerator. Development of SPIDER and MITICA is progressing in parallel. Realization and commissioning of SPIDER have been successfully completed and the first experimental phase has begun. During the installation of the components some issues were identified and are being thoroughly analyzed. Since the first operation is at low power and for a short duration, those problems which are not critical for the experiments in the near term are deferred to subsequent shut-downs. In this way a robust and scientifically meaningful experimental program can be carried out for the first months alongside a stepladder approach towards full performance capability while meeting the required operational parameters in each experimental phase. The MITICA project is also at a well-advanced stage of realization, although completion of the system and its entry into operation is not expected until 2023 due to the long procurement time of the in-vessel mechanical components. The power supply (PS) systems of MITICA, designed to operate at 1 MV, are in

an advanced phase of realization, all the high-voltage (HV) components have been installed and the complex insulation test phase began in 2018.

The present paper gives an overview of the progress of the NBTf development with particular emphasis on issues that emerged during this phase of activity and to the solutions adopted to minimize the impact on the schedule and maintain the goals of the facilities. Finally, the first results of the SPIDER experiment and of the 1 MV insulation tests on the MITICA HV components will be presented.

## 2. SPIDER

SPIDER is the prototype of the negative ion source for the HNB. The RF source design was based on the R&D developed at IPP in the past years [7], with specific improvements to achieve long-duration pulses on a full ITER-size ion source, in a vacuum environment and with optimized beamlet optics. The main requirements for SPIDER are reported in table 1. The beam optics will be investigated and compared with numerical models both in terms of beamlet divergence and beam aiming, and of different methods for negative ion steering [8]. The SPIDER experiment will also confirm the design of the 800 kW inductive plasma source and the cooling efficiency of the ion source and extractor, which are the same as for MITICA. As SPIDER operation started in 2018, it will provide timely confirmation of the design of the ion source and extractor during the manufacturing of the MITICA beam source.

### 2.1. Power supply and auxiliary systems

The period from 2015 to 2017 saw a number of activities related to system realization processes, i.e. acceptance tests and integration of the components into the whole system. Interface management was challenging in this phase. The objective was to complete PSs and auxiliaries before commencing commissioning and the experimental activities scheduled for the beginning of 2018. The ion source and extractor power supplies (ISEPS) include the RF generators feeding the RF coils around the drivers, the extraction grid HV generator and other secondary PSs for pre-ionization filaments, magnetic filter, etc; they are installed inside a Faraday cage (high-voltage deck, HVD) and powered via an insulation transformer. The ISEPS, HVD and the transmission line (TL) connecting the HVD to a vacuum vessel (VV) were completed, tested and accepted in 2016. Subsequently, they were commissioned and integrated with the control system (CODAS) and Interlock on dummy loads and made ready for use in the experiment [9].

Similarly, a gas and vacuum plant and cooling plant were installed and commissioned by 2017. Unfortunately, due to an accident that occurred at the end of 2017, part of the cooling system was flooded and partially damaged. A temporary solution was soon identified and implemented allowing the experiment to start, albeit with reduced performance. Indeed preliminary studies showed that this solution allowed the first

**Table 1.** Spider requirements.

	H <sub>2</sub>	D <sub>2</sub>
Beam energy (keV)	100	100
Maximum beam source pressure (Pa)	0.3	0.3
Maximum deviation from uniformity (%)	±10	±10
Extracted current density (A m <sup>-2</sup> )	>355	>285
Beam-on time (s)	3600	3600
Co-extracted electron fraction ( $\frac{e^-}{H^-}$ ), ( $\frac{e^-}{D^-}$ )	<0.5	<1



**Figure 1.** SPIDER accelerator power supplies: left, dummy load; right, insulating frames with pulse step modulator modules.

experimental campaigns to be carried out, including beam extraction for tens of seconds, without limitations, and to carry out in parallel recovery activities of the damaged parts.

Some difficulties were found during the installation of the accelerator PSs (AGPS) (see figure 1), which led to a delay in the availability of the system, as well as additional unexpected problems with proper integration of the system with the buildings and the adaptations necessary to meet the safety requirements prescribed by Italian laws. In particular, provisions had been made to achieve the required fire segregation capability of the wall facing the outdoor oil transformers, complicated by the presence of many resin feedthroughs crossed by HV cables. Subsequently, site acceptance tests of the AGPS were successfully carried out, and in very limited time, demonstrating the full performance of the system, thanks to the debugging previously carried out on an identical prototype available at the premises of the Indian DA [10]. Also in this case, the presence of a delay in the availability of the PS system did not affect the initial phases of SPIDER experimental activity since acceleration of the beam was not required. Integration of the AGPS with the whole system was performed in the first quarter of 2019.

### 2.2. The beam source (BS) and the overall commissioning

Given the complexity of the system, the realization of the ion source, which is the core of the SPIDER experiment, required great effort and continuous monitoring by the companies involved and by the expert supervisors. Many technical issues were encountered during the manufacturing and assembly of components [11], for example the surface conditions of the cooling circuit elements, which degraded the quality of the

cooling water in terms of electrical conductivity, and the polluted/oxidized internal surfaces of the source, which are provided with a molybdenum layer to reduce the sputtering yield of surface material during cesium operation. Each of these problems was analyzed in detail by applying multidisciplinary competencies; despite efforts to implement all individual corrective actions, the issues were eventually addressed resulting in a delay to the conclusion of the procurement while still leaving a few points open, like a leak on a grounded grid segment which would have required a significant time to recover. Pre-assembly activities were completed in the first half of 2017, immediately followed by factory acceptance tests. During the realization, some modifications were also implemented, taking into account recent results obtained in other accompanying experiments, such as decoupling the eight RF drivers by electromagnetic shields, derived from experience in the ELISE facility. Some novel concepts of the SPIDER design were validated in parallel in existing experiments, such as the magnetic compensation of electron and ion trajectories, tested at QST in Japan [12].

The BS was delivered to the NBTf premises by the end of October 2017. Visual inspections and on-site tests were carried out before installation into the vessel. To this end, a series of tools were set up, such as a Class 8 cleanroom; a dedicated scaffolding was realized and installed inside the vessel to allow easy access to all parts of the BS during the installation and the first commissioning phase. The precise mechanical alignment of accelerator grid apertures was finally achieved: deviations of a maximum  $\pm 0.2$  mm for the relative off-axis position of corresponding apertures on different grids were measured again on site [11], in line with the design requirements. The source was installed in the vessel in the first quarter of 2018 (figure 2), thus complying with the ITER milestone and allowing the start of experiments. The needs for corrections and improvements, identified during these phases, for example a leaky Grounded Grid (GG) segment (already under procurement), the incorrect assembly of a group of permanent magnets and enhancement of the electrical connections of the drivers as a consequence of results obtained in ELISE [13] and HVRFTF [14], together with simulations carried out at Consorzio RFX [15], will be addressed in the major shutdown scheduled for 2019 (see section 2.4). Quartz driver cases are under consideration to replace the current alumina, and optimized Vespel<sup>®</sup> combs holding the RF coils detached from the insulating cases are being developed in order to minimize the electrical field intensity in this critical area.

### 2.3. Diagnostics ready for the first operation

All SPIDER diagnostic systems have been developed within a common procurement program well integrated with the overall experimental schedule [16]. Acquisition of key diagnostic components for the BS was completed in due time, allowing a logical integration of their assembly with those of the other SPIDER systems, in particular with the installation of the BS and with integrated commissioning of the CODAS dedicated to diagnostics. Installation and integration of beam

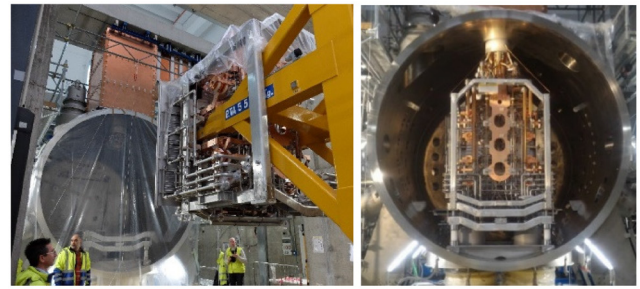

**Figure 2.** Left: Insertion of the SPIDER beam source inside the vacuum vessel by a handling tool; right, SPIDER beam source inside the vacuum vessel.

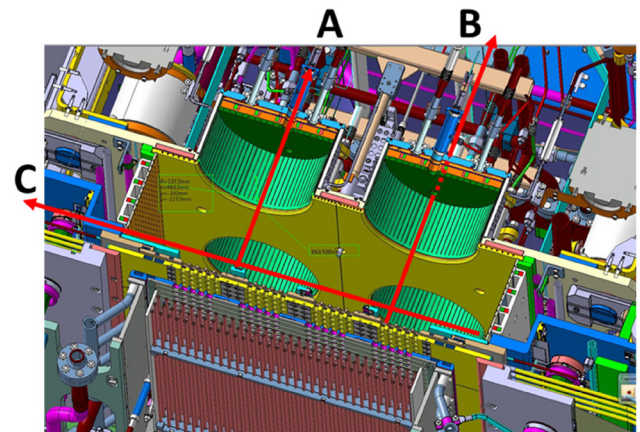

**Figure 3.** Horizontal cross section of the SPIDER beam source with lines of sight of emission spectroscopy, looking through each driver perpendicularly to the grids with: (A) light collection in a vacuum to photodiodes; (B) outside the vacuum vessel to spectrometers; (C) parallel to the grids to spectrometers.

diagnostics has been postponed to the beam extraction experimental phase so as not to overload the tight schedule for preparation of the initial source experiments. An initial set of diagnostics was operating during the first plasma experiments, with two purposes: on the one hand to complete their integration within the automated pulse procedure, to tune the setting up by optimizing the measured signals, to characterize the RF-induced noise and to investigate mitigation actions for issues; on the other hand to simultaneously provide information essential to steer the source operation, allowing us to understand the effects of the available parameters. High-resolution (2 megapixel) CMOS visible cameras with a high dynamic range (70 dB) look at the back and the sides of the source through viewports on the VV. Cameras proved essential for following and identifying the spatial distribution of undesired plasma discharges occurring outside the source case, in between source components and between the source and VV (see section 2.4). Several lines of sight sample the visible radiation emitted by the plasma, perpendicularly to the grids, through the drivers and parallel to the grid in the expansion and extraction regions (figure 3). Imaging grating spectrometers measure, along about 30 lines of sight distributed over the source and aligned perpendicular and parallel to the grids, either the full 300–900 nm spectrum with low

resolution (for Balmer hydrogen lines and identification of undesired pollutants such as metals or water-related compounds) or narrower bands with high resolution (Fulcher molecular hydrogen lines). These absolutely calibrated line intensities are being analyzed to derive the degree of hydrogen dissociation and electron temperature and density. However, they are immediately useful to depict trends in time and spatial distribution of plasma emissivity and to understand how they scale with operational parameters such as RF power, gas pressure or magnetic filter field (see section 2.4). While spectrometers acquire spectra with a sampling rate of a few Hz, faster single-channel detectors based on silicon photodiodes and low-noise amplifiers with programmable gain measure the light intensity through the eight RF drivers at 100 kSamples  $s^{-1}$  [17] using collimating lenses and fibers installed in a vacuum on the driver back plate. These detectors follow in finer detail the time evolution of plasma formation in the drivers and even the fast dynamics accompanying the external plasma discharges. So far thermocouples are measuring a small temperature increase after each plasma shot because of the short duration and low RF power; significant RF-induced noise still prevents their use during the pulse, but mitigation actions are under investigation. Electrostatic probes have been fully integrated and will be the next diagnostic to start operation, while the other source diagnostics, cavity ring down spectroscopy and laser absorption, will be installed and integrated at a later stage.

#### 2.4. The SPIDER experiments: first results and issues

After the integrated commissioning of plants and control systems [9] SPIDER operation started in mid-May 2018 with a preliminary characterization of gas pressure and pre-ionization filament circuits [18], namely the parameters that have the greatest effect on the formation of the plasma and the evolution of the beam [19]. Finally, plasma ignition was also characterized [18]. A numerical model was set up to interpret the transient behavior of the gas considering long inlet pipes and grid conductance. In steady state a calibration of the source pressure relative to the vessel pressure was performed; a factor of four was found, as expected from numerical simulations [20]. The electron current emitted by the pre-ionization filaments was measured in different conditions as a function of the heating current, also with the aim of inserting suitable protection resistors in the heating circuit to extend the filament lifetime, but producing an electron current sufficient for plasma ignition of a few mA per filament. The ignition procedure used by IPP for the ELISE device [21] was adopted when powering single SPIDER generators (corresponding to pairs of drivers in the same row), with some adaptations to the specific experimental constraints encountered in SPIDER. After reaching the required pressure for ignition, the RF power was ramped up to the desired value; during the increase of the RF power, the plasma generally ignites with a source pressure  $>0.2$  Pa and a ramping rate of RF power of 1–2.5 kW  $s^{-1}$ . The magnetic filter field is required during the plasma ignition phase for single-generator operation, but it can be zero when two generators are employed, even when the

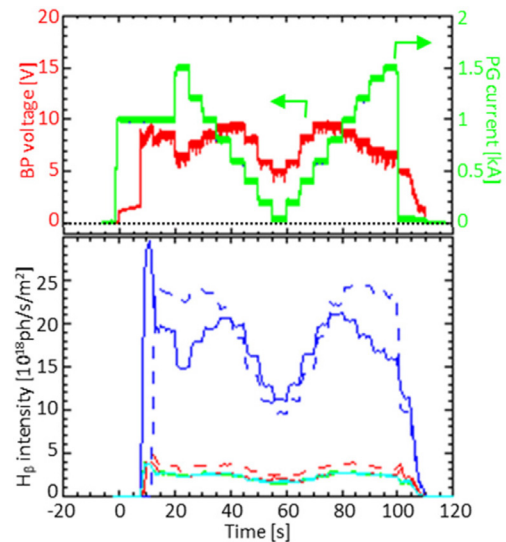

**Figure 4.** Scan of filter field current and bias plate voltage (top);  $H_{\beta}$  line intensity through the drivers (bottom; see text for symbols).

corresponding pairs of drivers are not neighboring, and possibly the plasmas they produce do not overlap significantly.

The SPIDER control system allows programming of the waveforms of the various PSs. Thus complete parameter scans can be performed within single pulses. As an example, figure 4 shows a scan in the magnetic filter field; during the first SPIDER experiments, scans were also performed of the RF power and of the source pressure [18, 22]. Indeed, plasma light and spectroscopy signals show a dependence on these parameters: upon increasing the magnetic filter field, the  $H_{\beta}$  Balmer lines integrated through the operating RF drivers (continuous and dashed blue curves in figure 4) exhibit a dependence (although a non-monotonic one). In the same figure the decay of the bias plate voltage indicates that the plasma in the vicinity of the bias plate becomes weaker as the magnetic field current increases, except for the smallest magnetic field values.

The data of figure 4 refer to a case in which only two drivers out of eight were operated; in these conditions, the signals of the  $H_{\beta}$  Balmer lines integrated through non-operating RF drivers (red and cyan curves) are much weaker, although not zero: this might indicate that some plasma expansion occurs out of the operating RF drivers. Figure 5 shows the  $H_{\beta}$  emission integrated through one of the RF drivers when either all RF generators were operating or when only the RF generator corresponding to the driver was operating. The dependence on the RF power is similar in the two cases, but the values almost double when all RF generators are on.

Also the plasma light collected through the drivers exhibits some non-monotonic dependence on the magnetic filter field (figure 6). However, the clearest dependence is on the RF power (possibly corresponding to an increase in electrons and hydrogen atoms). This is confirmed by figure 7, which also shows that a two-fold increase in the plasma light can be obtained by increasing the RF power but also the source pressure. The plasma light and the intensity of the  $H_{\beta}$  hydrogen line of the Balmer series exhibit some left–right asymmetry (see continuous and dashed blue curves in figure 4 for the  $H_{\beta}$

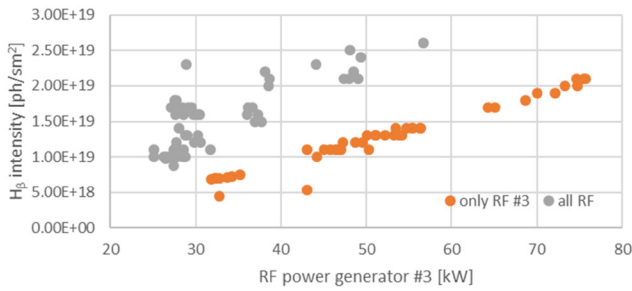

**Figure 5.**  $H_3$  emission integrated through RF driver #3 when operating all RF generators (grey) or only the corresponding RF generator (orange). Filter field current 300 A, source pressure 0.4 Pa. With all generators, the total power fed to the source is four times the one reported on the x-axis.

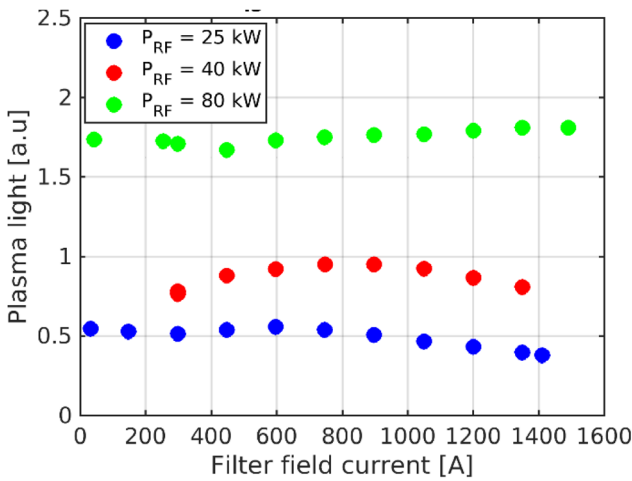

**Figure 6.** Plasma light signal through the RF drivers as a function of the magnetic filter field with different RF powers. Source pressure 0.32 Pa.

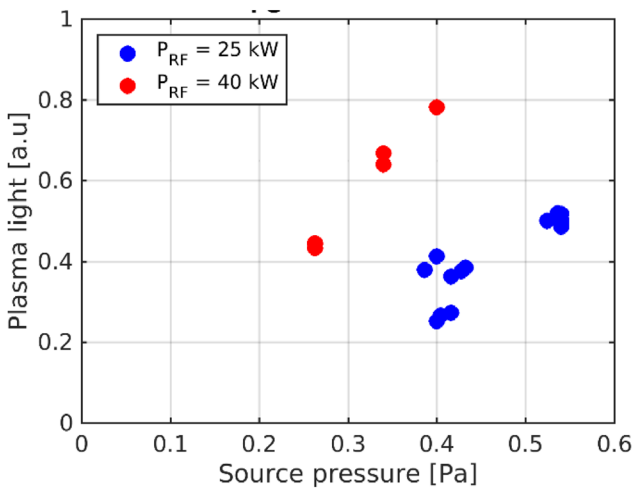

**Figure 7.** Plasma light signal through the RF drivers as a function of the source pressure with different RF powers. Filter field current 300 A.

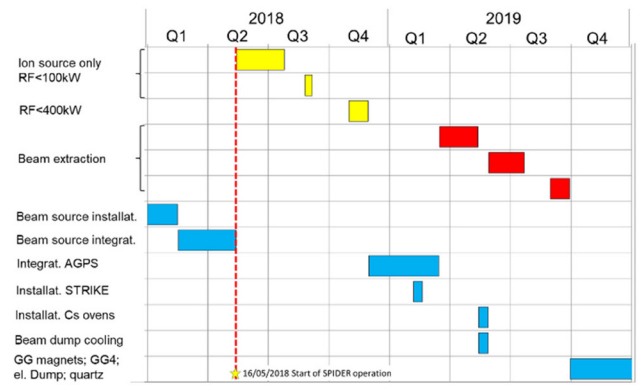
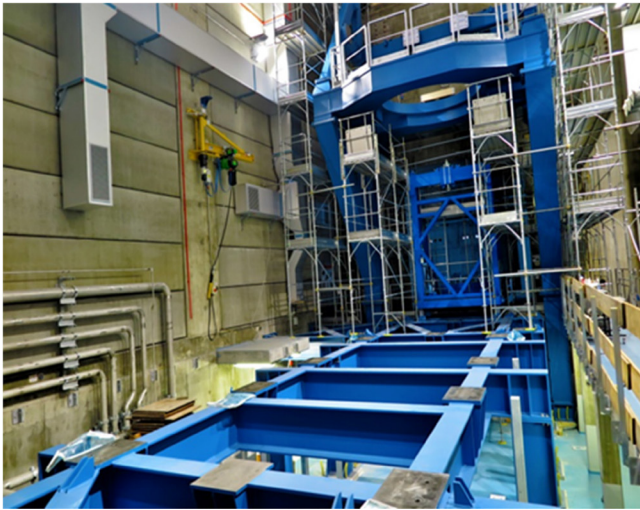

**Figure 8.** SPIDER operations and planning during 2018 and 2019. The shutdown periods are also indicated.

Balmer line), which seems to decrease with both increasing pressure and RF power and apparently increases with the magnetic filter field. The reasons for such possible plasma drift are under investigation.

The first SPIDER operations evidenced some issues. A short circuit between the plasma grid and source body was eliminated. Plasma discharges occurred outside the plasma chamber. Correspondingly, the filament bias PS was subjected to over-voltages so that protections had to be strengthened. Direct inspection showed signs of electrical discharges inside the VV, as on the busbars of the RF circuits, on the filament supports and on the internal surface of the VV. These discharges are peculiar to SPIDER, where the entire beam source, including the HV grids, lies inside a VV, namely at low gas pressure. A thorough investigation of the conditions of occurrence of the rear discharges is in progress using fast cameras (to follow the path of individual arcs across the source) and is aimed at identifying the vessel pressure range in which these discharges can be avoided. Subsequently, the necessary measures will be implemented to guarantee that SPIDER will be operated in the proper vessel pressure range.

Figure 8 shows SPIDER operations and planning for 2018 and 2019. After the characterization of the ion source and the integration of the accelerator grid PS, the extractor and accelerator entered into operation in the second quarter 2019. At the beginning of 2019 the cesium ovens were tested in the cesium test stand (CATS) [23], a small facility dedicated to the characterization of the cesium emitted from the oven nozzles, and in autumn 2019 they will be installed in SPIDER, producing an expected increase in the negative ion current. Experimentation with the beam will continue until the start of a major shutdown devoted to substitution of the insulator inside RF coil [15], based on the most recent indications originating from numerical optimizations and from the ELISE experiment performed during the assembly phase of the SPIDER source. Further reasons for the shutdown are the resolution of some non-conformities in SPIDER source manufacturing (i.e. a leak in one of the sectors of the grounded grid) and other improvements to the device suggested by the



**Figure 9.** MITICA vacuum vessel support structure and high-voltage bushing support structure as finally assembled inside the MITICA neutron shield.

experiment. After the shutdown SPIDER operation will restart and will be devoted to increasing the beam performance.

### 3. MITICA

#### 3.1. General progress

The design phase of MITICA was completed in 2016 and all calls for tender were launched. Common plant systems for SPIDER and MITICA, such as a MV power grid, cooling plant and gas injection and vacuum system, are in a very advanced stage of realization, installation or commissioning. The PS systems are all in an advanced phase of realization or already completed and installed; the same applies to the cryogenic plant. Procurement contracts for the BS and cryopumps were assigned, while the first phase of the process for the procurement of the beam line components (revision of the design including realization of prototypes by potential suppliers) is nearing completion and will be followed by a mini-competition among the three bidders for supplier selection.

Although the delivery of MITICA VVs was delayed by some major technical issues encountered during contract execution, a robust corrective action plan was developed to ensure the realization of a technical solution, which is being implemented and closely monitored. Moreover, the support structure of the VV and the vertical mechanical support structure of the HV bushing (HVB) (see figure 9) have been installed in order to reduce the duration of the installation of the HVB and of the connection of the TL once the VV is installed. Accurate metrology and a careful installation procedure allowed the successful execution of a static test using the HVB itself.

The most critical procurement is the BS [24], from the point of view of both technological complexity and delivery time. In fact, the BS includes the accelerator, consisting of a system of seven parallel grids each featuring 1280 apertures that must be aligned within tolerances of 0.3–0.4 mm. Grid deformations must be compatible with such tolerances even

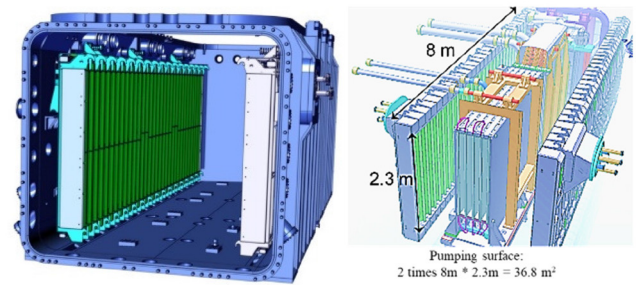

**Figure 10.** View of the cryopumps inside the MITICA beam line vessel (left) and with the beam line components (right).



**Figure 11.** View of the on-going assembly of MITICA cryogenic plant—auxiliary cold box (left) and piping layout inside the building for auxiliaries (right).

in the presence of ion-beam-induced thermal loads as high as 1.5 MW per grid. The manufacturing process of the grids is very complex and long and dictates the supply time of the entire BS. The supply contract has just been awarded; the BS is expected to be completed and delivered by the end of 2022, allowing the start of MITICA experiments by mid 2023.

#### 3.2. The MITICA cryogenic system

Two large cryopumps will be installed inside the MITICA beam line vessel (BLV) to guarantee proper vacuum conditions inside the vessel during MITICA operation (figure 10). The cryopumps are based on adsorption pumping by charcoal-coated cryopanel (CP); they are 8 m long, 2.8 m high and 0.45 m deep and operated between 4.5 K and 400 K. These CPs are surrounded by a thermal radiation shield (TRS) operated between 80 K and 400 K. The CPs will be at the lower temperatures during normal operations and at 100 K or 400 K during the periodic pump regenerations necessary to remove the adsorbed gas ( $H_2$  or  $D_2$ ) from the CPs. The pumping speeds estimated for the two pumps operating in parallel are  $5000 \text{ m}^3 \text{ s}^{-1}$  for  $H_2$  and  $3800 \text{ m}^3 \text{ s}^{-1}$  for  $D_2$ .

The MITICA cryogenic plant is designed to manage the expected heat loads in a pulse-on scenario: 800 W on the CP assembly (by producing supercritical helium at 4.6 K) and 17.4 kW on the TRS assembly (by gaseous helium at 81 K). The same plant shall also manage the regeneration of cryopumps at different temperatures. The procurement contract for the MITICA cryogenic plant was launched in September 2016; at present the on-site installation activities are in progress (figure 11) and the completion of acceptance tests on-site is foreseen by the end of 2019. The procurement contract



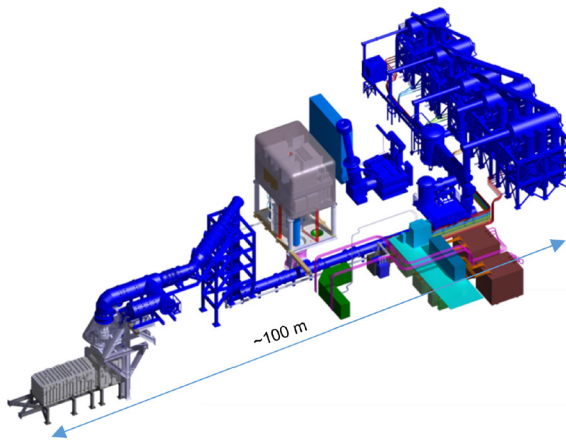

**Figure 12.** Three-dimensional view of MITICA power supply system. The high-voltage components provided by JADA are in blue. All other components included in the vacuum vessel are procured by F4E.

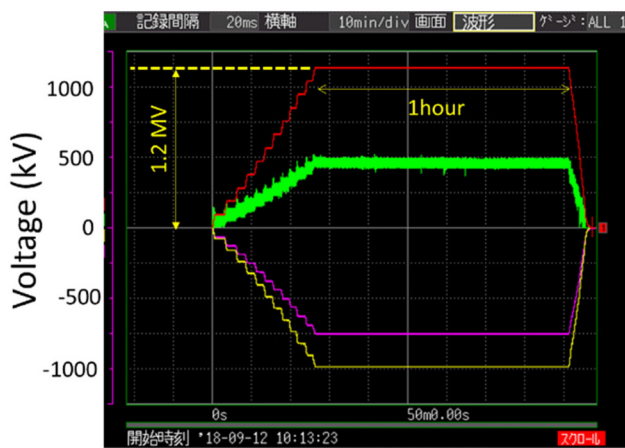
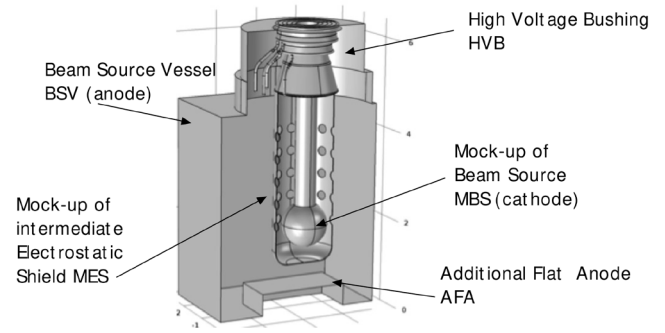

**Figure 13.** MITICA high-voltage test, first step: 1200 kV for 1 h.

for MITICA cryopumps began in May 2018 and delivery to NBTF site is foreseen by the end of 2020.

### 3.3. The power supplies

The MITICA PS system is very complex, and is based on the same conceptual scheme as applied to SPIDER [25]. The system is provided with contributions from both European and Japanese industries. Figure 12 shows a 3D model of this system which includes a HV TL (over 100 m long) and also requires a HV hall to host a 1 MV Faraday cage (HVD1) containing the MITICA ISEPS. The operating voltage, 1 MV, necessary for the accelerator requires remarkable technological developments at the cutting edge of present-day technologies. The realization is well advanced; some PS systems provided by F4E, such as the AGPS conversion system and HVD1, have already been installed and tested; other PSs were tested at the factory and installed by the end of 2018. As for the Japanese HV components, shown in blue in figure 9, the installation began at the end of 2015 and continued over the following 2 years. Unfortunately, the delay in the delivery of the VV has prevented the installation of the HVB and the



**Figure 14.** Sketch of the experimental setup for the high-voltage tests in the MITICA vessel, showing a mock-up of the beam source (MBS), a mock-up of the intermediate electrostatic shield (MES), the additional flat anode (AFA) and the beam source vessel (BSV). The beam line vessel is not shown.

connection of the TL to the HVB. To limit the impact of the unavailability of the MITICA VV on completion and power tests of the PSs, an alternative plan was adopted. In particular, a special cap was procured and installed at the end of the TL in correspondence to the not yet installed HVB, thus allowing the TL to be filled with the SF<sub>6</sub> insulating gas to carry out the HV insulation tests. An additional insulation test will be done after completing the installation of the VV to check the HV electrical insulation of the last part of the line and of the HVB.

**3.3.1. HV insulating tests.** The commissioning and integrated power test activities will require a period of about 2 years due to the complexity of the PS system itself and because the different systems are under different responsibilities (IO, F4E, JADA and NBTF teams). The HV components must be individually subjected to insulation tests before being connected to the PSs. Different HV components provided by JADA and F4E are to be connected to each other. The HV tests will have to be repeated up to five times as the various parts of the system are added one by one. Furthermore, it is necessary to completely evacuate the gas-insulated components and to ventilate them with air to guarantee safe access for the operators. Then the reverse operations shall be performed and the gas re-injected. Such procedures will require several months and can only take place in series, therefore any delays in one of these activities would result in a progressive delay of the availability of the PSs; moreover delay of the activities under responsibility of one DA can impact the activities under other DAs or parties. In July 2018, all the activities of installation and preliminary verifications of JADA HV components were completed. During the same period, the SF<sub>6</sub> gas handling and storage plant was made available by F4E, including the storage of approximately 35 tons of SF<sub>6</sub> gas. The first filling operation of the components with SF<sub>6</sub> was made, after a preliminary test in which the components were filled with nitrogen in order to avoid risks of release of SF<sub>6</sub> in the environment in case of faults of some components. At the beginning of September 2018 the first insulation test was performed to verify the voltage holding of the AGPS direct current generator (DCG) components: step-up transformers, diode rectifiers, DC filters. Two different tests, agreed upon among parties, simulate the operating conditions of the system: 1.2 MV dc for 1 h; 1.06

MV for 5 h followed by 5 quick sawteeth up to 1.2 MV [26]. The tests were positively passed by the system. After having reconfigured the internal connections to the line, the 1.2 MV voltage test was repeated in November 2018 in order to test the HV TL. Both batches of HV tests have been passed positively, without any inconvenience, allowing another important milestone on the road of the NBTF project to be reached. Figure 13 shows the voltage profiles measured by the HV transducers on the stages of AGPS DCG system during the 1.2 MV voltage test of the DCG system. Now the system is being set up to test the air-insulated components: HVD1 and the insulating transformer. A special piece connecting TL and HVD1 HVB was installed, and all the other activities necessary to prepare this test, which is particularly critical due to the presence of the air insulation, are well advanced. These additional insulation tests were started in March 2019 but due to partial discharges, they were interrupted at 900kV. Subsequently, while waiting for the introduction of improved solutions and in order to limit the impact on the overall schedule, we proceeded with the installation of the VV and the HVB. Now, the isolation tests are expected to resume in the beginning of July 2019, thus limiting the additional delay to a few weeks.

### 3.4. Tests of high-voltage-holding capability in a vacuum

The voltage-holding capability of the 1 MV insulation between the BS and the VV in MITICA is still a very challenging issue which could not be fully addressed on the basis of the theoretical models and experimental results available in literature so far. The acceptance tests of the MITICA HVB carried out by QST at Hitachi in 2016 [27] showed that the voltage holding of a single gap (about 1 m between an electrode at  $-1$  MV and ground) in high vacuum might already be critical at about 700 kV, but also indicated that the introduction of intermediate shields can greatly improve the voltage holding of the insulation, up to a limit of about 1.3 MV. As a consequence of these findings, additional effort was devoted to the refinement of theoretical prediction models [29] and to experimental investigations of solutions for improvement in a dedicated 800 kV HV test facility [28]. At the same time, as a possible risk-reduction measure for reliable operation of MITICA at 1 MV, an intermediate electrostatic shield between the BS (cathode) and the vessel (anode) was proposed. However, due to the unavoidable neutral gas flow exiting the plasma chamber, the intermediate electrostatic shield could also increase the 'vacuum' pressure in the volume around the BS and thus could move the points corresponding to the operating condition (pressure–distance) of the insulating gaps towards or beyond the left branch of the Paschen gas breakdown curve. With this in mind, an experimental campaign on full-scale electrodes at full-voltage in both high vacuum and low-pressure gas is deemed necessary to validate and optimize the performance of the MITICA insulation. This campaign will be carried out just after the assembly of the MITICA vessel at the NBTF site, before the installation of the MITICA BS, so as to avoid any delay in the schedule for NBTF completion. A very simple configuration with a mock-up of the BS (cathode) and a flat movable electrode (anode) will be used in a first phase (figure

14). In a second phase, a mock-up of the electrostatic shield, with holes for gas flow, can be introduced in the test set-up. In a reasonable time (of the order of some months), this approach is expected to provide reliable data on voltage holding with large electrodes, under realistic conditions, up to more than 1 MV, in both vacuum and low-pressure gas, with and without an intermediate shield. The results will allow us to confirm the present design of the MITICA BS insulation or to design an intermediate electrostatic shield if necessary for the operation at 1 MV.

## 4. Summary

Realization of the NBTF is progressing well thanks to the commitment of all the participants in the project. Although some components of the PS and of the cooling system are still unavailable, SPIDER has entered into operation and is providing the first data on the source plasma. This corresponds to the attainment of an important ITER milestone: as the NBTF is part of the ITER project it also represents the start of experimentation for the first part of ITER. During a long shutdown scheduled to start at the end of 2019 a leaking grid segment will be substituted, the RF drivers will be modified, according to recent numerical and experimental results and other interventions will be performed as indicated by the experimentation. All MITICA auxiliaries are being installed or commissioned; most of the PSs were installed at the beginning of 2019. Despite a significant delay in the delivery of the VV, the insulation tests for the HV components are in progress according to an alternative plan, allowing us to partially recover the delay. In particular, the test up to 1.2 MV of the AGPS DCG and TL was successfully passed, reaching another goal on the NBTF roadmap. According to current planning, MITICA PS will be integrated in 2020 whereas the mechanical components will be installed inside the VV in 2022. Nevertheless, in the meantime the MITICA plant can be used for HV holding tests in a vacuum, one of the most important issues for MITICA operation.

## Acknowledgments

The work leading to this publication has been funded partially by Fusion for Energy (F4E). This publication reflects the views only of the authors, and F4E cannot be held responsible for any use which may be made of the information contained therein. The views and opinions expressed herein do not necessarily reflect those of the ITER organization. The authors have confirmed that any identifiable participants in this study have given their consent for publication.

## ORCID iDs





V. Toigo  <https://orcid.org/0000-0002-4925-4752>

R. Pasqualotto  <https://orcid.org/0000-0002-3684-7559>

P. Agostinetti  <https://orcid.org/0000-0003-2103-7630>

M. Agostini  <https://orcid.org/0000-0002-3823-1002>

E. Gaio  <https://orcid.org/0000-0002-9208-6862>

P. Jain  <https://orcid.org/0000-0003-3427-2090>  
 P. Veltri  <https://orcid.org/0000-0002-0625-1201>  
 H. Dhola  <https://orcid.org/0000-0001-8515-4129>  
 M. Cavenago  <https://orcid.org/0000-0003-4486-687X>

## References

- [1] ITER Physics Basis Expert Group on Energetic Particles, Heating and Current Drive and ITER Physics Basis Editors 1999 Chapter 6: plasma auxiliary heating and current drive *Nucl. Fusion* **39** 2495
- [2] Inoue T. et al 2001 *Fusion Eng. Des.* **56–7** 517
- [3] Hemsworth R.H.S. 2008 *Rev. Sci. Instrum.* **79** 02C109
- [4] Toigo V. et al 2017 *New J. Phys.* **19** 085004
- [5] Marcuzzi D. et al 2010 *Fusion Eng. Des.* **85** 1792
- [6] Toigo V. et al 2015 *Nucl. Fusion* **55** 083025
- [7] Heinemann B. et al 2017 *New J. Phys.* **19** 015001
- [8] Agostinetti P. et al 2011 *Nucl. Fusion* **51** 063004
- [9] Luchetta A. et al 2019 SPIDER integrated commissioning *Fusion Eng. Des.* (<https://doi.org/10.1016/j.fusengdes.2019.01.006>)
- [10] Singh N.P. et al 2018 Installation and initial run of 96 kV 7.2 MW acceleration grid power supplies 27th IAEA Fusion Energy Conference (FEC 2018, Gandhinagar, India 22–27 October 2018) [FIP/P1-39] (<https://www.iaea.org/events/fec-2018>)
- [11] Pavei M. et al 2019 SPIDER beam source ready for operation *Fusion Eng. Des.* (<https://doi.org/10.1016/j.fusengdes.2019.01.067>)
- [12] Chitarin G. et al 2017 *AIP Conf. Proc.* **1869** 030026
- [13] Heinemann B. et al 2018 Latest achievements of the negative ion beam test facility ELISE *Fusion Eng. Des.* (<https://doi.org/10.1016/j.fusengdes.2018.12.090>)
- [14] Maistrello A. et al 2018 *Fusion Eng. Des.* **131** 96
- [15] Recchia M. et al 2018 *AIP Conf. Proc.* **2052** 040010
- [16] Pasqualotto R. et al 2017 *J. Instrum.* **12** C10009
- [17] Pasqualotto R. et al 2019 Plasma light detection in the SPIDER beam source *Fusion Eng. Des.* (<https://doi.org/10.1016/j.fusengdes.2019.01.061>)
- [18] Serianni G. et al 2019 SPIDER in the roadmap of the ITER neutral beams *Fusion Eng. Des.* (<https://doi.org/10.1016/j.fusengdes.2019.04.036>)
- [19] Serianni G. et al 2017 *New J. Phys.* **19** 045003
- [20] Sartori E., Serianni G. and Dal Bello S. 2015 *Vacuum* **122** 275
- [21] Franzen P. et al 2015 *Nucl. Fusion* **55** 053005
- [22] Chitarin G. et al 2018 *AIP Conf. Proc.* **2052** 030001
- [23] Rizzolo A. et al 2019 Characterization of the SPIDER Cs oven prototype in the CAesium Test Stand for the ITER HNB negative ion sources *Fusion Eng. Des.* (<https://doi.org/10.1016/j.fusengdes.2019.01.053>)
- [24] Marcuzzi D. et al 2016 *Rev. Sci. Instrum.* **87** 02B309
- [25] Gaio E. et al 2008 *Fusion Eng. Des.* **83** 21
- [26] Tobar H. et al 2018 Completion of DC 1 MV power supply system for ITER neutral beam test facility 27th IAEA Fusion Energy Conference (FEC 2018, Gandhinagar, India 22–27 October 2018) (Gandhinagar) [FIP/P1-10] (<https://www.iaea.org/events/fec-2018>)
- [27] Umeda N. et al 2016 Development of ultrahigh voltage insulation technology for the power supply components in neutral beam system on ITER 26th IAEA Fusion Energy Conference (Kyoto, Japan 17–22 October 2016) [FIP/P4-10] (<https://www-pub.iaea.org/iaea-meetings/48315/26th-IAEA-Fusion-Energy-Conference>)
- [28] De Lorenzi A. et al 2011 *Fusion Eng. Des.* **86** 742
- [29] De Lorenzi A. et al 2018 *International Symposium on Discharges and Electrical Insulation in Vacuum (Greifswald, Germany 23–23 September 2018)* (<https://ieeedeis.org/event/international-symposium-on-discharges-and-electrical-insulation-in-vacuum/>)