



UNIVERSITÀ  
DEGLI STUDI  
DI PADOVA

Sede Amministrativa: Università degli Studi di Padova

Sede Consorziata: Università degli Studi di Bologna

Dipartimento di Tecnica e Gestione dei Sistemi Industriali, DTG Vicenza

Dipartimento di Ingegneria Industriale, DIN Bologna

---

**DOTTORATO DI RICERCA IN INGEGNERIA MECCATRONICA E  
DELL'INNOVAZIONE MECCANICA DEL PRODOTTO**

INDIRIZZO DI IMPIANTI INDUSTRIALI E LOGISTICA

CICLO XXIX

# The Impact of Occupational Safety on Logistics and Automation in Industrial Plants

*Impatti della sicurezza negli ambienti di lavoro sulla logistica e  
sull'automazione degli impianti industriali*

Tesi redatta con il contributo finanziario dell'Azienda Unità Sanitaria Locale (AUSL) di Bologna

**Coordinatore:** Chiar.mo Prof. Roberto Caracciolo

**Supervisore:** Chiar.ma Prof.ssa Cristina Mora

**Dottorando:** Lucia Botti





UNIVERSITÀ  
DEGLI STUDI  
DI PADOVA

Sede Amministrativa: Università degli Studi di Padova

Sede Consorzziata: Università degli Studi di Bologna

Dipartimento di Tecnica e Gestione dei Sistemi Industriali, DTG Vicenza

Dipartimento di Ingegneria Industriale, DIN Bologna

---

**DOTTORATO DI RICERCA IN INGEGNERIA MECCATRONICA E  
DELL'INNOVAZIONE MECCANICA DEL PRODOTTO**

INDIRIZZO DI IMPIANTI INDUSTRIALI E LOGISTICA

CICLO XXIX

# The Impact of Occupational Safety on Logistics and Automation in Industrial Plants

*Impatti della sicurezza negli ambienti di lavoro sulla logistica  
e sull'automazione degli impianti industriali*

Tesi redatta con il contributo finanziario dell'Azienda Unità Sanitaria Locale (AUSL) di Bologna

**Coordinatore:** Chiar.mo Prof. Roberto Caracciolo

**Supervisore:** Chiar.ma Prof.ssa Cristina Mora

**Dottorando:** Lucia Botti



# ABSTRACT

---

Research on workplace health and safety analyses the integration of work practices with safety, health and wealth of people at work. The aim of occupational safety is to realize a safe and health work environment, eliminating or reducing the risks for workers' safety and health.

The objective of this thesis is the study, integration, development and application of innovative approaches and models for decision-making support in the context of occupational safety in industrial plants and logistics. Such methodologies are expected to lead practitioners and decision-makers, in particular safety professionals and companies, in the management of occupational safety.

In particular, this research focuses on the integration and application of ergonomics principles to reduce biomechanical overload of manual work, and methodologies and solutions to improve safety of confined space work in industrial plants.

The study of biomechanical overload due to manual handling of loads and awkward postures is the object of several researches and publications addressing the ergonomic risk assessment and the ergonomic approach to remove or reduce the risk of manual handling injuries and disorders. Furthermore, when awkward postures are assumed in high-risk workplaces as confined spaces, the overall risk of work is extremely high. Confined space work is a high-risk activity, posing a significant hazard for both workers and rescuers involved in the emergency response. The leading cause of accidents and fatalities in confined spaces is atmospheric condition (Sahli & Armstrong 1992, Harris et al. 2005, Flynn & Susi, 2010, Meeker, Susi & Flynn 2010, Ye 2011, Bellamy 2015). Further common causes are fire, explosion, ignition of flammable contaminants, spontaneous combustion and contact with temperature extremes. Besides, work activities in confined spaces (e.g., welding and maintenance tasks) frequently require awkward and static postures, at high temperatures.

This thesis stresses the importance of implementing health and safety interventions at workplace. These interventions have impact not only on enterprise level but also on individual and social levels. Furthermore, protection of human life is a matter of human rights and human life has an invaluable value.

In this thesis, the role of occupational safety and safety strategy as means for the improvement of workers and companies' performances clearly emerges. Two parallel research fields on occupational safety are investigated: ergonomics and confined spaces. Selected data are introduced related to occupational accidents and diseases due to biomechanical overload and work in confined spaces. The literature survey on controls for risk elimination and reduction shows that technology for safety is available. Nevertheless, injuries and accidents still occur, i.e. safety is frequently considered an expensive investment and a compliance obligation.

Specifically, administrative and engineering controls for risk elimination and reduction are introduced for each research field. Administrative controls include work procedures and mathematical models for the design of safe work processes. Such control methods reduce the workers' exposure to

occupational risk factors. The ergonomic analysis of manual handling activities drives the modelling by multi-objective optimisation problems in the design of administrative controls for the ergonomic risk reduction in different industries. Administrative controls for risks in confined spaces include work procedures, a multi-criteria decision tool and the analysis of the requirements of Internet of Things (IOT) technologies for reducing the risk of confined space work. The introduction of automation to replace manual work and engineering controls for confined space work are analysed for the risk elimination. Results show that the integration of ergonomics and safety principles in the industrial processes plays a leading role in the successful implementation of the overall strategy. Technologies for safe confined space work and technical solutions assisting workers during manual material handling tasks have been the focus of the Solutions Database Project, funded by the Azienda Unità Sanitaria Locale of Bologna (AUSL), Italy. The study of such technological and technical solutions lead to the development of the Solutions Database, a free access database available online for researchers and practitioners (<http://safetyengineering.din.unibo.it/en/banca-delle-soluzioni>).

The thesis ends with the recommendation that companies should integrate workplace health and safety principles to human resource management and work organisation. The management of health and safety issues should be considered to be crucial for workplace development, as a lever to increase performance and productivity. Finally, this research aims to support and reinforce the evolution of the concept of safety in industry, from *ex post* required obligation, to *ex ante* optimisation strategy.

# SOMMARIO

---

L'attività di ricerca in materia di salute e sicurezza negli ambienti di lavoro analizza l'integrazione tra le attività lavorative e la sicurezza, la salute e il benessere dei lavoratori. Lo scopo di tale scienza è di realizzare un ambiente di lavoro sano e sicuro, eliminando o riducendo i rischi per la salute e la sicurezza dei lavoratori.

L'obiettivo di questa tesi è lo studio, l'integrazione, lo sviluppo e l'applicazione di approcci innovativi e modelli di supporto alle decisioni in merito alla sicurezza occupazionale negli impianti industriali e nella logistica. Tali metodi vogliono essere una guida per chi mette in pratica i principi della sicurezza nei luoghi di lavoro, quali aziende e professionisti della sicurezza, e coloro che sono chiamati a prendere decisioni in merito alla gestione della sicurezza dei lavoratori.

In particolare, questa ricerca si focalizza sull'integrazione e l'applicazione dei principi dell'ergonomia per la riduzione del sovraccarico biomeccanico dovuto alle attività manuali, e di metodi e soluzioni per migliorare la sicurezza del lavoro negli ambienti confinati presenti negli impianti industriali.

Lo studio del sovraccarico biomeccanico dovuto alla movimentazione manuale dei carichi e alle posture incongrue è l'obiettivo di numerose ricerche e pubblicazioni in merito alla valutazione del rischio ergonomico e all'approccio ergonomico per la rimozione e la riduzione del rischio d'infortuni e malattie professionali legate alla movimentazione manuale dei carichi. Inoltre, quando le posture incongrue sono assunte all'interno di ambienti lavorativi ad alto rischio, quali gli ambienti confinati, il rischio complessivo del lavoro diventa molto elevato.

Il lavoro all'interno degli ambienti confinati è un'attività a elevato rischio, che espone sia i lavoratori che i possibili soccorritori coinvolti nella risposta d'emergenza a un elevato pericolo. La causa principale degli infortuni e degli incidenti mortali all'interno degli ambienti confinati è la condizione atmosferica presente nell'ambiente. Altre cause frequenti sono il fuoco, esplosione, presenza di contaminanti infiammabili, combustione spontanea e contatto con temperature elevate. Inoltre, l'attività lavorativa negli ambienti confinati (es., saldatura e manutenzione) richiede spesso posture statiche ed incongrue, mantenute in presenza di elevate temperature.

Questa tesi sottolinea l'importanza dell'attuazione tempestiva degli interventi per il miglioramento delle condizioni di salute e sicurezza sul posto di lavoro. Questi interventi hanno un impatto non solo a livello aziendale, ma anche a livello individuale e sociale. Inoltre, la protezione del lavoratore è questione di diritti umani, e la vita umana ha un valore inestimabile.

In questa tesi, emerge chiaramente il ruolo della strategia di gestione della sicurezza sul lavoro come mezzo per il miglioramento dei lavoratori e delle prestazioni aziendali. Due ambiti di ricerca in materia di sicurezza sul lavoro sono approfonditi parallelamente: l'ergonomia delle posture, dei movimenti e delle postazioni di lavoro, e le attività negli ambienti confinati. Saranno mostrati dati numerici e casistiche relative agli infortuni e alle malattie dovute al sovraccarico biomeccanico e al lavoro negli ambienti confinati, in ambito industriale. L'analisi della letteratura sui metodi per l'eliminazione e la

riduzione del rischio mostra la presenza di numerose tecnologie, ad oggi disponibili, per la sicurezza dei lavoratori rispetto a tali ambiti. Tuttavia, gli infortuni, gli incidenti e le malattie professionali sono ancora presenti, a dimostrazione del fatto che la sicurezza è spesso considerata un costoso investimento e un mero obbligo di conformità alla normativa cogente.

In particolare, questo elaborato presenta diverse metodologie di tipo amministrativo e tecnico per l'eliminazione e la riduzione del rischio in ciascun ambito di ricerca indagato. I controlli amministrativi comprendono procedure e modelli matematici per la progettazione dei processi di lavoro in sicurezza. Tali metodi di controllo riducono l'esposizione dei lavoratori ai fattori di rischio. L'analisi ergonomica delle attività di movimentazione manuale guida la modellazione dei problemi di ottimizzazione multi-obiettivo nella progettazione dei controlli amministrativi per la riduzione del rischio ergonomico in diversi settori industriali. I controlli di tipo amministrativo per la riduzione dei rischi in ambienti confinati includono procedure di lavoro, metodologie decisionali multi-criterio e l'analisi dei requisiti dei sistemi basati sulle tecnologie dell'Internet delle cose (IOT) per ridurre il rischio del lavoro negli ambienti confinati. L'introduzione dell'automazione a sostituzione del lavoro manuale e le metodologie tecniche per il controllo del rischio durante il lavoro negli ambienti confinati vengono presentati come strumenti per l'eliminazione del rischio. I risultati mostrano come l'integrazione dei principi dell'ergonomia e della sicurezza nei processi industriali svolga un ruolo di primo piano per il successo dell'attuazione della complessiva strategia aziendale.

La tesi termina con la raccomandazione che le aziende dovrebbero integrare i principi di salute e sicurezza sul posto di lavoro per la gestione delle risorse umane con la strategia organizzativa e produttiva aziendale. La gestione dei problemi e dei rischi per la salute e la sicurezza dei propri lavoratori dovrebbe essere considerata come cruciale per lo sviluppo e il miglioramento dell'ambiente di lavoro, nonché un efficace leva per aumentare le prestazioni e la produttività dell'azienda. Infine, questa ricerca sostiene e rafforza l'evoluzione del concetto di sicurezza nel settore industriale, da *ex post* obbligo di adempimento a una normativa cogente, a *ex ante* strategia di ottimizzazione.





# The Impact of Occupational Safety on Logistics and Automation in Industrial Plants

by  
Lucia Botti

Submitted in fulfilment of the requirements for the Degree of  
Doctor of Philosophy

University of Padua – University of Bologna  
Doctoral School of Mechatronics and Product Innovation Engineering

15<sup>th</sup> November 2016

*“There is no such thing as an accident,  
only a failure to recognize the hand of fate”*

*Napoleon*



# TABLE OF CONTENTS

---

<b>1</b>	<b>INTRODUCTION</b>	<b>23</b>
1.1	RESEARCH MATRIX	25
1.2	THESIS OUTLINE	27
1.3	REFERENCES	30
<b>2</b>	<b>ERGONOMICS IN OCCUPATIONAL WORKPLACES</b>	<b>31</b>
<b>2.1</b>	<b>LITERATURE REVIEW ON ERGONOMICS</b>	<b>33</b>
2.1.1	REVIEW OF REGULATIONS IN FORCE	33
2.1.2	REVIEW OF TECHNICAL SOLUTIONS FOR ERGONOMICS	37
2.1.2.1	The Solutions Database Project	37
2.1.2.1.1	Research Methods and Criteria	38
2.1.2.2	Construction Industry	39
2.1.2.3	Agriculture	42
2.1.2.4	Meat Processing	44
2.1.2.5	Retail	47
2.1.2.6	Personal Service Assistance	50
<b>2.2</b>	<b>ADMINISTRATIVE CONTROLS FOR ERGONOMICS</b>	<b>54</b>
2.2.1	ERGONOMIC DESIGN FOR LEAN MANUFACTURING: A MATHEMATICAL MODEL FOR HYBRID ASSEMBLY LINES	55
2.2.1.1	The effects of lean thinking on ergonomics and human factors	55
2.2.1.2	Integrate ergonomics and automation in lean processes	57
2.2.1.3	Assembly process modelling	58
2.2.1.3.1	Operation assumptions	61
2.2.1.3.2	The mathematical model	61
2.2.1.4	Case study	64
2.2.1.5	Results and discussion	67
2.2.1.6	Conclusions and considerations on the ergonomic design of assembly lines for lean manufacturing	71
2.2.2	ERGONOMICS AND HUMAN RESOURCE MANAGEMENT: A MATHEMATICAL MODEL	73
2.2.2.1	Improving ergonomics through job rotation	73
2.2.2.2	The person-job fit problem	74
2.2.2.3	The mathematical model	76
2.2.2.4	Case Study	78

2.2.2.5	Results and discussion	79
2.2.2.6	Conclusions and considerations on the integration of ergonomics with human resource management	81
2.2.3	PROPER UTILIZATION OF TOOLS AND EQUIPMENT	83
2.2.3.1	The effect of feed force on hammer drill handle vibration and productivity	83
2.2.3.1.1	Materials and methods	84
2.2.3.1.2	Results	86
2.2.3.1.3	Case study	90
2.2.3.1.4	Discussion	92
2.2.3.1.5	Conclusions	93
2.2.3.2	Concrete drill bit wear patterns and productivity	95
2.2.3.2.1	Materials and methods	96
2.2.3.2.2	Results	98
2.2.3.2.3	Discussion	103
2.2.3.2.4	Conclusions	105
<b>2.3</b>	<b>ENGINEERING CONTROLS FOR ERGONOMICS</b>	<b>106</b>
2.3.1	PROCEDURE FOR THE INTRODUCTION OF ENGINEERING CONTROLS IN INDUSTRY	107
2.3.1.1	Practical Applications for Industry	112
2.3.1.1.1	Case Study 1: Application of an Engineering Control in the Meat-Processing Industry	112
2.3.1.1.2	Case Study 2: Application of an Engineering Control in the Retail Apparel Industry	116
2.3.2	INTEGRATING AUTOMATION IN TYPICAL MANUAL PROCESSES	123
2.3.2.1	The ergonomic risk in the meat-processing industry	123
2.3.2.2	Non-safety cost model	124
2.3.2.3	Meat processing industry in Emilia Romagna, Italy	125
2.3.2.4	Reference meat processing plant	126
2.3.2.5	Working conditions	127
2.3.2.6	Semi-automatic deboning system	128
2.3.2.7	Manual ham-deboning process versus semi-automatic ham-deboning system	130
2.3.2.8	Comparative and sensitive analysis	131
2.3.2.9	Discussion	132
2.3.2.10	Conclusions and considerations on the integration of automation in the manual ham-deboning process	133
<b>2.4</b>	<b>REFERENCES</b>	<b>135</b>
<b>3</b>	<b>SAFETY IN CONFINED SPACES</b>	<b>154</b>

<b>3.1</b>	<b>LITERATURE REVIEW ON CONFINED SPACES</b>	<b>156</b>
3.1.1	REVIEW OF REGULATIONS IN FORCE AND ACCIDENTS IN CONFINED SPACES	156
3.1.1.1	International regulation on confined space work	156
3.1.1.2	Brief accident analysis	160
3.1.2	REVIEW OF TECHNICAL SOLUTIONS FOR CONFINED SPACE WORK	162
3.1.2.1	Methods	162
3.1.2.2	Automated solutions for cleaning operations in confined spaces	164
3.1.2.2.1	Cleaning solutions for AST and UST	164
3.1.2.2.2	Cleaning solutions for ship hulls and tanks in the naval industry	166
3.1.2.2.3	Cleaning solutions for sewers and pipelines	167
3.1.2.3	Automated solutions for inspecting operations in confined spaces	168
3.1.2.3.1	Inspecting solutions for AST and UST	169
3.1.2.3.2	Inspecting solutions for ship hulls and tanks in the naval industry	172
3.1.2.3.3	Inspecting solutions for sewers and pipelines	173
3.1.2.4	Automated solutions for maintenance operations in confined spaces	174
3.1.2.4.1	Automated maintenance in AST and UST	174
3.1.2.4.2	Automated maintenance in ship hulls and tanks in the naval industry	176
3.1.2.4.3	Automated maintenance in sewers and pipelines	176
3.1.2.5	Discussion	177
3.1.2.6	Conclusions and considerations on available engineering controls for safe confined space work	178
<b>3.2</b>	<b>ADMINISTRATIVE CONTROLS FOR CONFINED SPACE WORK</b>	<b>180</b>
3.2.1	IOT FOR OCCUPATIONAL SAFETY	180
3.2.1.1	Brief state of the art analysis about the application of IOT technology for risk prevention and reduction in hazardous workplace	181
3.2.2	FRAMEWORK FOR PREVENTING AND MANAGING RISKS IN CONFINED SPACES	183
3.2.2.1	The structure of the framework	186
3.2.2.2	Impact analysis of IOT technologies for confined spaces	188
3.2.2.3	Conclusions and considerations on the proposed framework for managing the risks of confined space work	190
3.2.3	MULTI-CRITERIA DECISION TOOL TO CONTROL RISKS IN CONFINED SPACE	191
3.2.3.1	Analysis of confined space risks at process industries	191
3.2.3.2	The proposed multi-criteria model	192
3.2.3.3	Test case description	193
3.2.3.4	Results analysis	195
3.2.3.5	Conclusions and considerations on the proposed multi-criteria model for assessing IOT technology	196

<b>3.3</b>	<b>ENGINEERING CONTROLS FOR CONFINED SPACE WORK</b>	<b>198</b>
3.3.1	TOOL FOR THE IDENTIFICATION OF CONFINED SPACES IN INDUSTRY	198
3.3.1.1	Identifying confined spaces: a challenging task	198
3.3.1.2	Algorithm for the identification of a confined space	201
3.3.1.3	Confined Space Risk Index (CSRI)	206
3.3.1.4	Quick applications of the checklist and CSRI calculation	207
3.3.1.4.1	Case study 1: Grain silo	207
3.3.1.4.2	Case study 2: Metal tank in filtration plants	207
3.3.1.5	Findings and future developments	208
<b>3.4</b>	<b>REFERENCES</b>	<b>209</b>
<b>4</b>	<b><u>CONCLUSIONS</u></b>	<b><u>221</u></b>

---



# LIST OF FIGURES

---

FIGURE 1.1 RESEARCH MATRIX .....	25
FIGURE 1.2 THESIS OUTLINE STRUCTURE.....	27
FIGURE 2.1 BENEFITS OF ERGONOMICS IN THE WORKPLACE.....	34
FIGURE 2.2 HIERARCHY OF CONTROL MEASURES. ....	36
FIGURE 2.3 WEBPAGE OF THE SOLUTIONS DATABASE .....	38
FIGURE 2.4 EXAMPLE OF SOLUTION CONTAINED IN THE SOLUTIONS DATABASE .....	39
FIGURE 2.5 SCHEMATIC OF PROTOTYPE MASONRY SYSTEM (BERNOLD, ALTOBELLI & TAYLOR 1992).....	41
FIGURE 2.6 MACHINE WITH HYDRAULIC CLAMP FOR BRICK ASSEMBLY OF FLOORS (BURDORF ET AL. 2007). 42	
FIGURE 2.7 APPLE-HARVESTING ROBOT (DE-AN ET AL. 2011). ....	43
FIGURE 2.8 STRAWBERRY-HARVESTING ROBOT (HAYASHI ET AL. 2010). ....	44
FIGURE 2.9 FANUC M-710I ROBOT (DE-AN ET AL. 2011). ....	46
FIGURE 2.10 AUTOMATED SLAUGHTER LINE OF THE FUTURE (MADISON, NIELSEN AND MØNSTED 2006). ...	47
FIGURE 2.11 WITRON SRS SELF REPLENISHMENT SYSTEM (WITRON B). ....	49
FIGURE 2.12 JADE™ X7 PORTAL SCANNER (DATALOGIC A). ....	49
FIGURE 2.13 THE ROBOT ASSISTING A DISABLED USER (CORREAL ET AL. 2006). ....	51
FIGURE 2.14 BLOCK DIAGRAM OF THE INTELLIGENT SWEET HOME (JUNG ET AL. 2005). ....	51
FIGURE 2.15 ABB DUAL-ARM ROBOT. ....	53
FIGURE 2.16 EXAMPLE OF HYBRID ASSEMBLY LINE .....	59
FIGURE 2.17 SEQUENTIAL PROCESSING ALTERNATIVES IN HYBRID ASSEMBLY LINES. ....	59
FIGURE 2.18 LAYOUT OF THE REFERENCE ASSEMBLY PROCESS. ....	64
FIGURE 2.19 DISTRIBUTION OF RECOVERY PERIOD .....	66
FIGURE 2.20 NORMALIZED WIP-COST PARETO FRONTIER. ....	67
FIGURE 2.21 DECISION FUNCTION CHART FOR THE PARETO POINTS. ....	69
FIGURE 2.22 LAYOUT OF THE ASSEMBLY PROCESS FOR SOLUTIONS IN POINTS $W$ , $C$ AND $J=8$ . ....	70
FIGURE 2.23 DISTRIBUTION OF RECOVERY PERIODS .....	78
FIGURE 2.24 PARETO FRONTIER.....	80
FIGURE 2.25 $\sigma$ AND $\sigma$ VARIANCES FROM THE OPTIMAL VALUES $\sigma$ AND $\sigma$ . ....	80
FIGURE 2.26 DRILLING RATE VARIATION DURING DRILLING EIGHT TRIALS WITH A NEW $\frac{3}{4}$ " BIT AT 120N FEED FORCE. 85	
FIGURE 2.27 DRILLING RATE VARIATION DURING DRILLING EIGHT TRIALS WITH A NEW $\frac{3}{4}$ " BIT AT 200N FEED FORCE. 85	
FIGURE 2.28 UNWEIGHTED ACCELERATION MEASURES FOR EACH ACTUAL FEED FORCE VALUE. ....	86
FIGURE 2.29 WEIGHTED ACCELERATION MEASURES FOR EACH ACTUAL FEED FORCE VALUE. ....	87
FIGURE 2.30 DRILLING RATE FOR EACH ACTUAL FEED FORCE MEASURE.....	88
FIGURE 2.31 DAILY VIBRATION EXPOSURE FOR EACH FEED FORCE MEASURE. ....	90
FIGURE 2.32 AND FIGURE 2.33. PARAMETERS OF THE PROPOSED WEAR ANALYSIS METHOD FOR BIT 1.....	97

FIGURE 2.34 AND FIGURE 2.35 ....PARAMETERS OF THE PROPOSED WEAR ANALYSIS METHOD FOR BIT 2, BIT 3 AND BIT 4. 97

FIGURE 2.36	NEW BIT 1 (CONDITION 0).....	99
FIGURE 2.37	BIT 1 AFTER DRILLING 7.62 M (CONDITION 1). ....	99
FIGURE 2.38	BIT 1 AFTER DRILLING 38.10 M (CONDITION 5). ....	99
FIGURE 2.39	NEW BIT 2 (CONDITION 0).....	101
FIGURE 2.40	BIT 2 AFTER DRILLING 7.62 M (CONDITION 1). ....	101
FIGURE 2.41	BIT 2 AFTER DRILLING 15.24 M (CONDITION 2). ....	101
FIGURE 2.42	PROCEDURE FOR THE INTRODUCTION OF CONTROL MEASURES FOR ERGONOMICS. ....	108
FIGURE 2.43	PREPARATION OF THE MEAT MIXTURE FOR THE BLENDING MACHINE. ....	112
FIGURE 2.44	WORKERS UNLOADING FULL TRAYS INTO THE CARTS.....	113
FIGURE 2.45	SEMI-AUTOMATIC MANIPULATOR IN THE BLENDING AREA. ....	114
FIGURE 2.46	TRAY UNLOADING WITH THE SEMI-AUTOMATIC MANIPULATOR.....	115
FIGURE 2.47	CART EMPTYING IN THE SORTING AREA. ....	117
FIGURE 2.48	MANUAL WORKER PERFORMING CART EMPTYING.....	117
FIGURE 2.49	SEMI-AUTOMATIC HANDLING AND LIFTING DEVICE IN THE SORTING AREA.....	118
FIGURE 2.50	SEMI-AUTOMATIC LIFTING AND HANDLING DEVICE WITH LATERAL BARRIERS. ....	121
FIGURE 2.51	HAM FLOW IN THE REFERENCE MEAT PROCESSING PLANT. ....	126
FIGURE 2.52	MAYEKAWA HAMDAS-R ( <a href="http://www.mayekawa.com">WWW.MAYEKAWA.COM</a> ). ....	128
FIGURE 2.53	MAYEKAWA HAMDAS-R HAM-DEBONING PROCESS. ....	128
FIGURE 2.54	SEMI-AUTOMATIC DEBONING LINE PROPOSAL WITH THE MAYEKAWA HAMDAS-R HAM- DEBONING MACHINE.....	129
FIGURE 2.55	ERGONOMIC RISK ASSESSMENT RESULTS COMPARISON.....	133
FIGURE 3.1	NIOSH ACCIDENTS CLASSIFICATION BASED ON CAUSES AND NUMBER OF FATALITIES OCCURRED IN CONFINED SPACE.....	160
FIGURE 3.2	ITALIAN ACCIDENTS CLASSIFICATION BASED ON CAUSES AND NUMBER OF FATALITIES OCCURRED IN CONFINED SPACE.....	161
FIGURE 3.3	CLASSIFICATION OF ACCIDENTS BASED ON THE INDUSTRIAL SECTOR.....	161
FIGURE 3.4	SPRAYING CANNON (SCHÄFER AND URBACH 2015B).....	165
FIGURE 3.5	SIRO: THE SILOS SURFACE CLEANING ROBOT CONCEPT (DANDAN, ANANIEV & KALAYKOV 2013). 166	
FIGURE 3.6	LIGHT-WEIGHT MOBILE ROBOT FOR CONCRETE AND METAL SURFACES (KOVACIC ET AL. 2010). 167	
FIGURE 3.7	PIPE CLEANING AND INSPECTING ROBOT (TRUONG-THINH, NGOC-PHUONG & PHUOC-THO 2011). 168	
FIGURE 3.8	MAGNEBIKE, MAGNETIC WHEELED INSPECTION ROBOT (TÂCHE ET AL. 2009).....	170
FIGURE 3.9	NERO NUCLEAR ELECTRIC ROBOT OPERATOR SERIES (LUK ET AL. 2006). ....	171
FIGURE 3.10	SADIE SIZEWELL A DUCT INSPECTION EQUIPMENT SERIES (LUK ET AL. 2006). ....	171
FIGURE 3.11	NDT CLIMBING ROBOT FOR INSPECTION OF LONG WELD LINES (SHANG ET AL. 2008).....	172
FIGURE 3.12	LIGHTWEIGHT MAGNETIC CLIMBING ROBOT (EICH & VOGELE 2011). ....	173

FIGURE 3.13	AUTONOMOUS MAINTENANCE ROBOT AMR (KRASNY 2012).....	175
FIGURE 3.14	ROWER (GONZALES DE SANTOS, ARMADA, JIMENEZ 2000).....	176
FIGURE 3.15	GENERAL STRUCTURE OF AN IOT TECHNOLOGY-BASED SYSTEM. ....	180
FIGURE 3.16	THE PROCEDURE FOR THE PREVENTION AND MANAGEMENT OF CONFINED SPACES RISKS.....	184
FIGURE 3.17	THE PROPOSED FRAMEWORK. ....	187
FIGURE 3.18	THE PROPOSED IMPACT ANALYSIS OF IOT TECHNOLOGIES. ....	189
FIGURE 3.19	THE PROPOSED HIERARCHICAL STRUCTURE .....	193
FIGURE 3.20	CHARACTERISTICS OF CONFINED SPACES .....	200
FIGURE 3.21	ALGORITHM OF THE CONFINED SPACE IDENTIFICATION TOOL .....	203
FIGURE 3.22	CHECKLIST FOR THE IDENTIFICATION OF A CONFINED SPACE. ....	205
FIGURE 4.1	MATRIX OF THE RESEARCH CONCLUSIONS .....	223

# LIST OF TABLES

---

TABLE 2.1	ENGINEERING CONTROLS FOR CONSTRUCTION INDUSTRY .....	40
TABLE 2.2	ENGINEERING CONTROLS FOR AGRICULTURE.....	42
TABLE 2.3	ENGINEERING CONTROLS FOR MEAT PROCESSING .....	46
TABLE 2.4	ENGINEERING CONTROLS FOR RETAIL .....	48
TABLE 2.5	ENGINEERING CONTROLS FOR PERSONAL SERVICE ASSISTANCE.....	50
TABLE 2.6	INDICES AND PARAMETERS FOR THE ILP MODEL. ....	62
TABLE 2.7	OCRA PARAMETERS FOR THE ILP MODEL, REFERRED TO THE MOST STRESSED UPPER LIMB (ISO 11228-3, 2007).....	62
TABLE 2.8	DESCRIPTION OF THE TASKS FOR THE REFERENCE ASSEMBLY LINE.....	65
TABLE 2.9	CASE STUDY PARAMETERS.....	65
TABLE 2.10	OCRA PARAMETERS FOR THE ERGONOMIC RISK ASSESSMENT THROUGH OCRA METHOD.....	65
TABLE 2.11	OCRA INDEX VALUES FOR THE ERGONOMIC RISK ASSESSMENT OF ASSEMBLY LINE WORKERS IN THE REFERENCE ASSEMBLY LINE. ....	66
TABLE 2.12	PARETO POINTS COORDINATES.....	68
TABLE 2.13	DECISION FUNCTION VALUES FOR EACH J POINT. ....	69
TABLE 2.14	OCRA INDEX VALUES FOR THE ERGONOMIC RISK ASSESSMENT OF ASSEMBLY LINE WORKERS IN POINT C AND POINT J=8.....	71
TABLE 2.15	ITEMS TO DEFINE THE PERSON-JOB FIT.....	75
TABLE 2.16.	WORKSTATION ASSESSMENT: SCORES FOR THE ITEMS OF EACH CATEGORY.....	75
TABLE 2.17.	WORKER ASSESSMENT: SCORES FOR THE ITEMS OF EACH CATEGORY.....	75
TABLE 2.18	INDICES AND PARAMETERS FOR THE ILP MODEL .....	76
TABLE 2.19	OCRA PARAMETERS FOR THE ILP MODEL (ISO 11228-3 2007) .....	77
TABLE 2.20	WORK SYSTEM FEATURES .....	79
TABLE 2.21	OCRA INDECES FOR THE MOST EXPOSED WORKERS TO THE ERGONOMIC RISK. ....	81
TABLE 2.22	ACCELERATION VALUES FOR EACH FEED FORCE MEASUREMENT.....	88
TABLE 2.23	FEED FORCE, EXPOSURE TIME AND DRILLING RATE FOR EACH REFERENCE FORCE MEASUREMENT.....	91
TABLE 2.24	DECISION FUNCTION VALUES FOR EACH J POINT. ....	91
TABLE 2.25	PARAMETERS OF THE BIT WEAR ANALYSIS METHOD.....	97
TABLE 2.26	DRILLING PROCESS DETAILS AND FEATURES OF THE FOUR CARBIDE DRILL BITS. ....	98
TABLE 2.27	PARAMETERS OF THE BIT WEAR ANALYSIS METHOD AND PRODUCTIVITY DATA FOR BIT 1 IN EACH CONDITION.....	100
TABLE 2.28	PARAMETERS OF THE BIT WEAR ANALYSIS METHOD AND PRODUCTIVITY DATA FOR BIT 2. ....	102
TABLE 2.29	PARAMETERS OF THE BIT WEAR ANALYSIS METHOD AND PRODUCTIVITY DATA FOR BIT 3. ....	102
TABLE 2.30	PARAMETERS OF THE BIT WEAR ANALYSIS METHOD AND PRODUCTIVITY DATA FOR BIT 4. ....	102
TABLE 2.31	COEFFICIENT OF DETERMINATION R <sup>2</sup> FOR THE BIT SHAPE PARAMETERS AND PRODUCTIVITY. .	103
TABLE 2.32	ERGONOMIC RISK ASSESSMENT SCORES FOR MANUAL DEBONING LINE WORKERS.....	127

TABLE 2.33	MAYEKAWA HAMDAS-R SPECIFICATIONS .....	129
TABLE 2.34	COMPARISON OF MANUAL HAM-DEBONING PROCESS VERSUS SEMI-AUTOMATIC HAM-DEBONING SYSTEM 130	
TABLE 2.35	ERGONOMIC RISK ASSESSMENT SCORES FOR WORKERS AT THE SEMI-AUTOMATIC DEBONING LINE 130	
TABLE 2.36	COMPARATIVE AND SENSITIVE ANALYSIS .....	131
TABLE 3.1	STANDARDS FOR CONFINED SPACE.....	156
TABLE 3.2	BIBLIOGRAPHIC RESOURCES AND KEYWORDS USED IN THE REVIEW PROCESS .....	163
TABLE 3.3	CLASSIFICATION OF AUTOMATED ENTRY TECHNOLOGIES FOR CONFINED SPACE WORK DEPENDING ON CONFINED SPACE TYPE AND ACTIVITY. ....	177
TABLE 3.4	CLASSIFICATION OF AUTOMATED ENTRY TECHNOLOGIES DEPENDING ON THE ABILITY TO PERFORM MULTIPLE TASKS.....	177
TABLE 3.5	ESTIMATED SCORE VALUES FOR EACH CRITERION AND THE THREE FINAL ALTERNATIVES .....	196
TABLE 3.6	RANGES THAT DEFINE RISK LEVELS.....	206



# 1 INTRODUCTION

---

Workplace health and safety is the study of the integration of work practices with safety, health and wealth of people at work. The aim of occupational safety is to realize a safe and health work environment, eliminating or reducing the risks for workers' safety and health.

Manual workers performing manual material handling (MMH) of loads for a long time are exposed to multiple risk factors that contribute to the development of Work-Related Musculoskeletal Disorders (WMSDs), e.g., the most common tendonitis, low back pain and carpal tunnel syndrome. In particular, MMH and high repetition movements are the main risk factors associated with WMSDs and low back pain (Şener et al. 2015, Asensio-Cuesta et al. 2012). The negative effects of WMSDs encompass a broad-spectrum of diseases, which have dramatic effects on the performances of the workers and, consequently, on the overall productivity of the work system. Several studies have investigated the correlation between manual material handling of loads, awkward postures and their effect on productivity, satisfaction and fatigue of manual workers. Results have shown that working activities involving repetitive movements of the upper limb and frequent manual handling operations increase the fatigue and the boredom of workers while reducing their performance, satisfaction and safety level (Azizi, Zolfaghari & Liang 2010, Fonseca, Loureiro & Arezes 2013).

A further critical field of occupational safety concerns the study of confined spaces and the elimination of the risks of confined space work. Work in confined spaces is still causing fatal accidents and injuries, despite the reinforcement of the worldwide regulatory and standards. Confined spaces are defined as limited or restricted areas not designed for continuous occupancy where employees enter and perform a specific task. Examples of confined spaces include, but are not limited to tanks, vessels, silos and pipelines. Confined space work is a high-risk activity, posing a serious dangerous hazard to the workers. Hazards in confined spaces are difficult to evaluate and manage, due to the complex characteristics of such particular work environments (Nano and Derudi, 2014). Both the features of the confined area and the characteristics of the performed task have direct impact on the overall risk level of a specific confined space activity. Despite international efforts in defining consistent procedures and recommendations for safe confined space work, the recent statistics show that fatal incidents still occur (Burllet-Vienney et al., 2014). Several accidents and injuries related to confined space work showed that workers access to confined areas without proper training and personal protective equipment, exposing themselves to high levels of hazards (Nano and Derudi, 2012). The lack of situation awareness is an underlying cause of human errors, especially when workers access to areas not designed for continuous occupancy as confined spaces. One potential contribution for preventing and reducing risks could be derived by the

application of Internet of Things (IOT) technologies to increase context awareness of both workers inside and outside the confined space (Manca et al., 2012, Manca et al., 2014).

The application and integration of risk assessment methodologies, administrative controls and engineering controls for risk elimination or reduction in the analysis of economic and safety performances of manual processes is the focus of this thesis. The research focuses on the integration of work organization with health and safety. The strong connection between productivity and health and safety at work is investigated, showing that both interventions supporting company goals and performance and health and safety interventions at workplace are a key to business excellence.

Two parallel research fields are explored: ergonomics in workplaces and safety in confined spaces. Through the implementation in multi-objective optimisation models and work procedures, companies' strategies as job rotation and lean thinking principles have been included in decision support tools for the optimal design and planning of administrative controls for the risk reduction. These models show that work organisation has a significant impact on the relationship between health and safety at work and productivity. The study of engineering controls for the risk elimination investigates the adoption of automation and automated technology to replace manual processes in industry. Case studies prove the effectiveness of the proposed control methods and support the idea that occupational safety impacts company performance.



# 1.1 RESEARCH MATRIX

The research presented in this dissertation has been developed following the structured matrix in Figure 1.1. Such a matrix is organised according to a main issue, i.e. Workplace Health and Safety, a set of sub-topics, i.e. ergonomics in workplaces and safety in confined spaces, a set of risk control methods, and a series of applications on industrial case studies, obtained by the combination of topics and control methods.

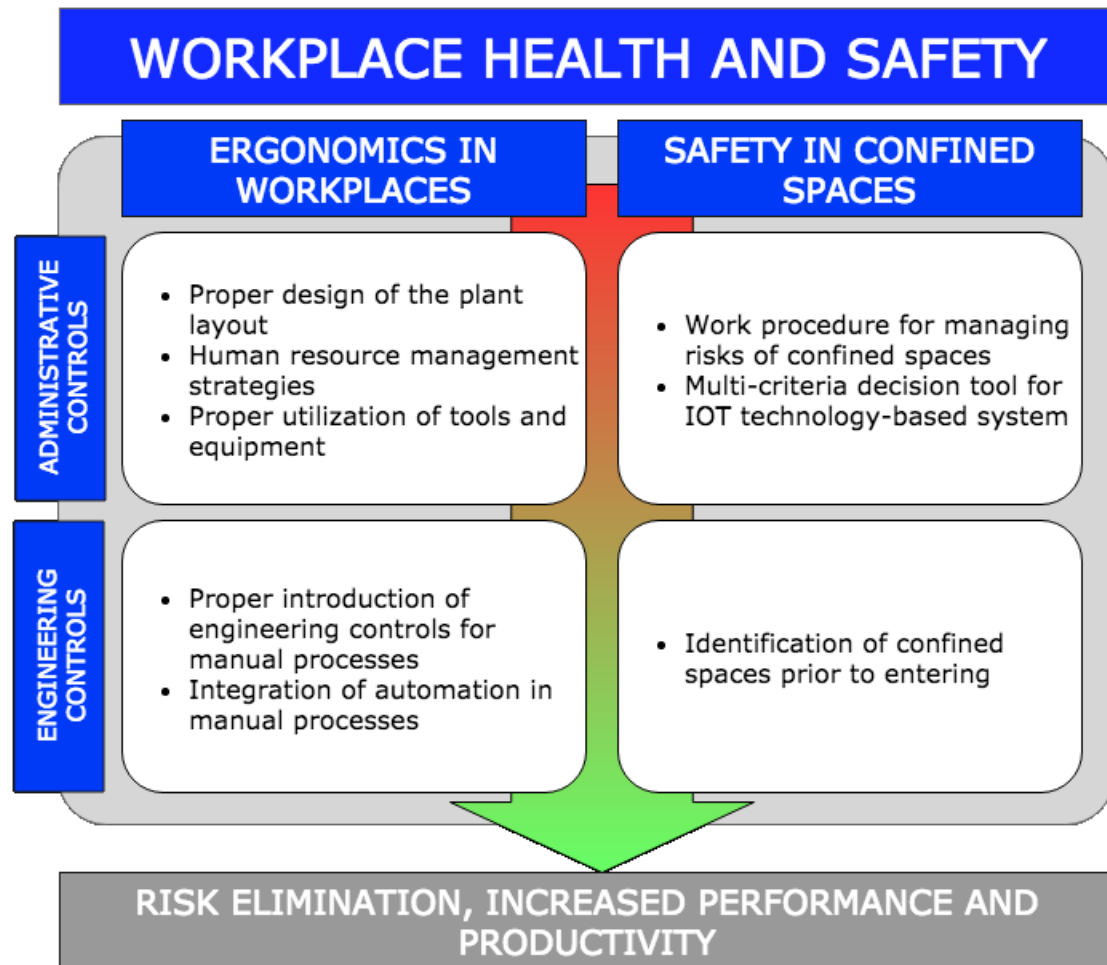

Figure 1.1 Research matrix

Workplace Health and Safety is defined as the study of health and well being of people at work. Among the several issues that fall under the umbrella of Workplace Health and Safety, in this thesis the topics of Ergonomics in Workplaces and Safety in Confined Spaces have been considered as particularly relevant and of greatest interest, as such two issues are industry-wide problems and cause high incidence of work-related diseases and accidents.

The occupational health and safety regulations and guidelines require to eliminate the risk or to reduce the exposure by means of engineering and administrative controls. Specifically, engineering controls eliminate or reduce exposure to a physical hazard through the adoption

or substitution of engineered machinery and equipment. Administrative controls, or work practice controls, involve changes in the work organization or in work procedures, e.g., training of workers, safety procedures and job schedules.

Topics and control methods find their intersection in the applications proposed in this thesis. This research has been addressed on four main areas: the development of administrative controls as decision support tools to reduce the ergonomic risk of manual work; the integration of engineering controls for the elimination of the ergonomic risk in manual processes; the design of administrative controls to reduce the risk of confined space work, and the development of decision support tools for the elimination of the risks of confined space work.

The choice of a so extended range of applications is explained by the will to address the risks of two critical fields of Workplace Health and Safety in industry. Since there is no solution that fits every specific issue, different approaches and methodologies have been selected, adapted and applied. In a few cases, the integration of several methods has been required in order to approach different problems from different viewpoints. As a result, this research shows an evolutionary itinerary in the evolution and application of methodologies for Workplace Health and Safety: from the mere application of safe work procedures and ergonomics principles in workplaces, to its combination with automation in industrial processes and its completion with multi-scenario and sensitivity analysis, to the final integration of economic and ergonomics principles in multi-objective optimisation.

# 1.2 THESIS OUTLINE

This thesis has been developed in accordance with the research matrix presented above. Topics, control methods and applications have been debated and arranged in a sequence of chapters, as shown in Figure 1.2.

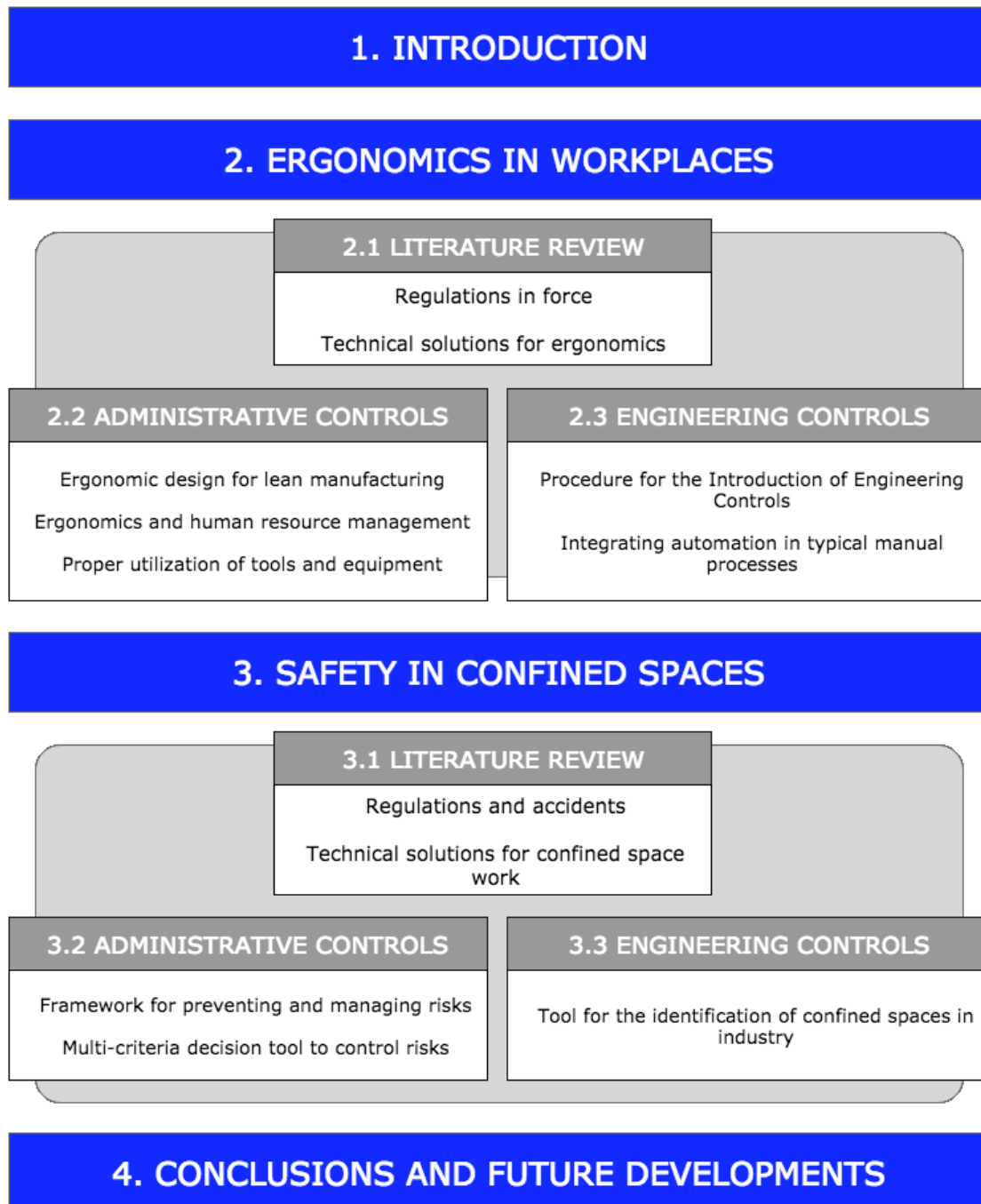

Figure 1.2 Thesis outline structure

After a brief introduction on workplace health and safety, the purpose of this research and the two research fields of ergonomics and safe confined space work have been presented in Chapter 1.

Chapter 2 proposes a detailed study on risk control methods for biomechanical overload. The chapter starts with a literature review on regulations in force (Section 2.1.1) and a review of technical solutions for the reduction of ergonomic risks in several industries (Section 2.1.2). Such solutions are included in Solutions Database, in the Ergonomics Section (<http://safetyengineering.din.unibo.it/en/banca-delle-soluzioni/ergonomia>). Section 2.2 introduces a set of novel administrative controls for the ergonomic risk reduction. The first is a mathematical model to define ergonomic lean processes in manufacturing assembly lines (Section 2.2.1). The aim was to design the optimal layout of the assembly processes that meet the lean goals of improving production efficiency and the ergonomic principles for manual material handling. Given the production requirements, product characteristics and assembly tasks, the model defines the assembly process for hybrid assembly lines with both manual workers and automated assembly machines. The effectiveness of the mathematical model was tested in a case study based on an assembly process for hard shell tool cases.

The aim of the second administrative control in Section 2.2.2 was to design ergonomic job rotation schedules to enhance the benefits of the task rotation and prevent MSDs. Firstly, the workers' competencies and abilities are compared with the activity requirements to prevent MSDs and including workers' disabilities. Such a perspective ensures the optimal person-job fit. Secondly, the job rotation system guarantees that high and low demand activities are alternated to support the recovery of the workers. These two perspectives lead to a trade-off between long and short rotation intervals. Both the proposed mathematical models include the ergonomic risk assessment to ensure the ergonomic safety of each worker.

The last administrative control aims to investigate the vibration exposure of construction workers and to improve their performances through the proper utilization of drilling tools and equipment (Section 2.2.3). The research has analyzed the correlation between vibrations, feed force and productivity during concrete drilling (Section 2.2.3.1). However, exposure to forceful exertion and vibration may be reduced depending on bit wear. The purpose of the study in Section 2.2.3.2 was to evaluate the relationship between bit wear patterns and drilling productivity (e.g., penetration rate in mm/s) which was measured using a test bench system for hammer drills. Image analysis methods were used to identify a set of wear parameters from bit images at various stages of wear.

Section 2.3 shows a review on engineering controls for ergonomics, together with the statistics on the incidence of work-related musculoskeletal disorders in industry, has highlighted a lack of directions and guidelines for the proper introduction of engineering controls in manual processes. The procedure in Section 2.3.1 aims to guide safety personnel and practitioners through the application of engineering controls in manual processes. Two case studies show the application of the procedure and its effectiveness in addressing the

elimination and the reduction of the exposure of workers to the risk of manual material handling. The study in Section 2.3.2. analyses the introduction of automated machinery in manual processes showing the impact of automation on the reduction of the cost of non-safety. Specifically, the research introduces a novel model for the quantification of the non-safety costs, which are the direct and indirect costs for injuries and work-related diseases in manual processes.

Chapter 3 investigates the hazards in confined spaces, proposing a set of control measures for the elimination and the reduction of the exposure of workers to the risk of confined space work. The study evaluates the potential contribution of IOT technologies to prevent and control the risks of confined space work. After a first legislative overview and a literature review on previous accidents in confined spaces, Section 3.1 introduces a systematic review of the automated solutions for high-risk activities in confined spaces, considering the non-man entry as the most effective confined space safety strategy. Such solutions are non-man entry technologies for confined space work that avoid the human entry in confined spaces. Furthermore, such solutions are included in Solutions Database, in the Confined Space Section (<http://safetyengineering.din.unibo.it/en/banca-delle-soluzioni/ambienti-confinati>). Section 3.2 proposes two administrative control methods for the reduction of the risk of confined space work. The first control method is a reference framework for analysing the hazards and the work procedures in confined spaces (Section 3.2.2). The aim was to define the impact of IOT technologies for preventing and managing confined space risks. Particularly, the proposed framework includes a stepwise procedure for the analysis of both the impact of IOT technology for safe confined space work and the technology requirements for the emergency and rescue operations. The latter administrative control conceptualizes an Analytical Hierarchy process (AHP) model for analysing how critical factors affecting dangerous scenarios in confined spaces could impact on the assessment of an IOT technology-based device for preventing and managing confined spaces risks (Section 3.2.3). A case study in the chemical industry is proposed to validate the approach. As a result of the conclusions presented in the previous Section 3.1 and 3.2, Section 3.3 introduces the structure of a tool for the identification of confined spaces in industry. The tool will help employers, workers, safety professionals and practitioners in recognizing high-risk confined spaces and avoiding the worker entry.

Results and conclusions of the research presented in this dissertation are then resumed in Chapter 4.

## 1.3 REFERENCES

- Asensio-Cuesta, S., Diego-Mas, J., Cremades-Oliver, L. & González-Cruz, M.C. 2012, "A method to design job rotation schedules to prevent work-related musculoskeletal disorders in repetitive work", *International Journal of Production Research*, vol. 50, no. 24, pp. 7467-7478.
- Azizi, N., Zolfaghari, S. & Liang, M. 2010, "Modeling job rotation in manufacturing systems: The study of employee's boredom and skill variations", *International Journal of Production Economics*, vol. 123, no. 1, pp. 69-85.
- Burlet-Vienney, D., Chinniah, Y. & Bahloul, A. 2014, "The need for a comprehensive approach to managing confined space entry: Summary of the literature and recommendations for next steps", *Journal of Occupational and Environmental Hygiene*, vol. 11, no. 8, pp. 485-498.
- Fonseca, H., Loureiro, I.F. & Arezes, P. 2013, "Development of a job rotation scheme to reduce musculoskeletal disorders: A case study" in *Occupational Safety and Hygiene*, ed. G. Perestrelo, CRC Press, , pp. 351-356.
- Manca, D., Nazir, S., & Colombo, S. (2012). Performance indicators for training assessment of control-room operators. *Chemical Engineering Transactions*, 26, 285- 290.
- Manca, D., Nazir, S., Colombo, S., & Kluge, A. (2014). Procedure for automated assessment of industrial operators. *Chemical Engineering Transactions*, 36, 391-396.
- Nano, G., Derudi, M., 2012. Evaluation of Workers Accidents Through Risk Analysis, *Chemical Engineering Transactions* , 16, 495-500.
- Nano, G., Derudi, M., 2014. A Critical Analysis of Techniques for the Reconstruction of Workers Accidents, *Chemical Engineering Transactions*, 31, 415-420.
- Şener, S., Sarıdoğan, E., Staub, S., Deros, B.M., Daruis, D.D.I. & Basir, I.M. 2015, "World Conference on Technology, Innovation and Entrepreneurship A Study on Ergonomic Awareness among Workers Performing Manual Material Handling Activities", *Procedia - Social and Behavioral Sciences*, vol. 195, pp. 1666-1673.

# 2 ERGONOMICS IN OCCUPATIONAL WORKPLACES

---

Repetitive work including manual material handling of loads at high frequency involves a significant stress of the upper limb, mainly affecting hand and wrist, but even shoulders and low back. Lifting, reaching, and performing repetitive activities with moderate force, cause excessive stress on joints and tendons if performed at high frequency or for a long time.

The biomechanical overload induced by these activities commonly lead to deteriorated postures, awkward body positions and muscular fatigue. Such behaviours are the main cause of occupational diseases as cumulative trauma disorders and WMSDs, e.g., tendonitis, low back pain and carpal tunnel syndrome. WMSDs are considered one of the most common and expensive occupational diseases. Furthermore, WMSDs increase the risk of errors and frequently result in reduced productivity and quality.

Physical and psychosocial factors as the characteristics of tasks and workers, and the work organization are the main risk factors for WMSDs. Other additional factors include the work conditions as noise, illumination, climate and vibration. The health and safety regulations and guidelines require to eliminate the risk or to reduce the exposure by means of engineering and administrative controls. Specifically, engineering controls eliminate or reduce exposure to a physical hazard through the adoption or substitution of engineered machinery and equipment. Administrative controls, or work practice controls, involve changes in the work organization or in work procedures, e.g., training of workers, safety procedures and job schedules. The regulations on workplace health and safety recommend the use of administrative controls if engineering controls are not available.

After a literature review on the regulations in force and available technical solution for ergonomics, this chapter introduces innovative administrative and engineering controls for the elimination and the reduction of the risk of biomechanical overload. Section 2.2 presents three administrative controls for ergonomics to prevent the ergonomic risk. The first administrative control involves the proper design of the plant layout to reduce the exposure of the workers to the ergonomic risk. The second administrative control deals with the design of human resource management strategies meeting the ergonomics principles and the ergonomics regulations. Finally, the proper utilization of tools and equipment drives the principles behind the design of third administrative control.

Engineering controls are the most effective control measure for the risk elimination as they protect workers by removing the hazardous conditions or by placing a barrier between the worker and the hazard (see Section 2.1). Section 2.3 introduces an effective procedure for

the introduction of engineering controls in industry, together with the application of an engineering control adopting automation in a typical manual process.



# 2.1 LITERATURE REVIEW ON ERGONOMICS

## 2.1.1 Review of regulations in force

Ergonomics and the design of ergonomic workplaces are reaching the attention of many industries and companies. Activities requiring awkward postures, repetition and excessive strain lead to WMSDs and to a consequent increase in absenteeism (Fonseca, Loureiro & Arezes 2013). WMSDs are the most popular occupational health problem in the European Union (Fonseca, Loureiro & Arezes 2013). Such diseases cause more than 40% of the total annual lost-time and are considered one of the most costly occupational problems (Xu et al. 2012). Furthermore, bad postures as bent wrists, raised arms at or above shoulder level and long periods of standing are associated with an increased risk for injury (EU-OSHA 2008). The negative impact of such phenomena affects the productivity of the industries, the safety and the satisfaction among workers.

The past and recent literature widely discusses the contribution of ergonomics to the optimization of both the human being and the overall system performances (Dul, Neumann 2009). The operating cost incurred by worker injury increase when the safety requirements are disregarded. Consequently, the profit made by the operation strongly diminishes as well as the overall company productivity (Snook 1978).

Manufacturing industries are under increasing pressure to improve their productivity and to reduce delivery times and cost. Such pressure affects workers as well, causing harmful effects on their mental and physical health. The higher the influence of the external environment on the equilibrium of the organization, the more a holistic approach is required (Fonseca, Loureiro & Arezes 2013). Managers usually associate ergonomics with occupational health and safety, despite many studies prove the effectiveness of the ergonomic design to the overall system performances. The integration of ergonomics in the workplace brings significant benefits for workers and companies. The following Figure 2.1 is inspired by the SUVA publications on ergonomics, available at the website [www.suva.ch/waswo](http://www.suva.ch/waswo) (SUVA 2003).

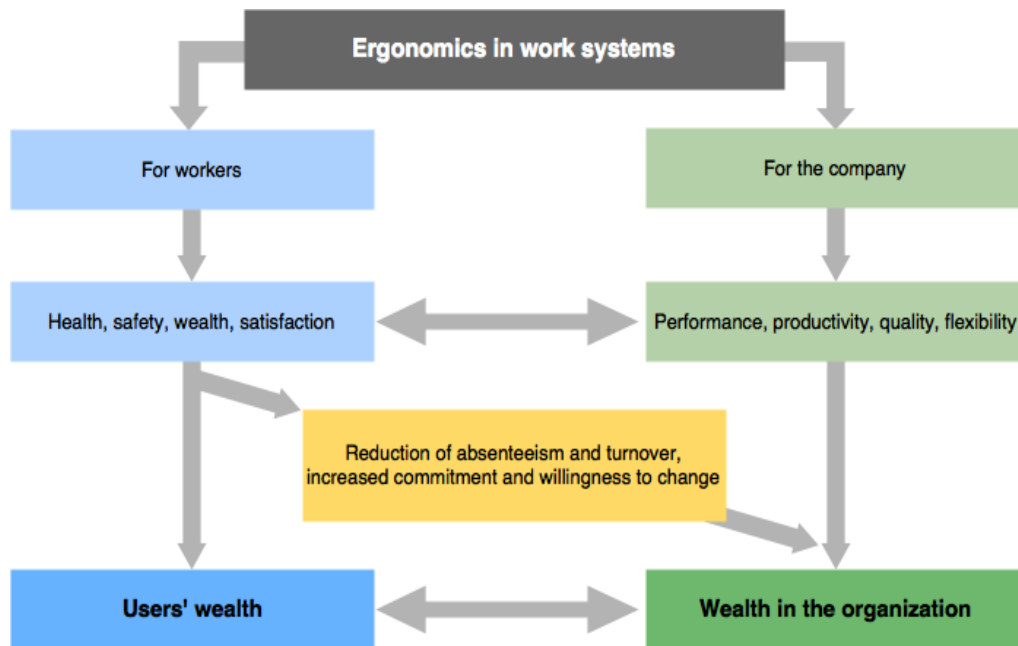

Figure 2.1 Benefits of ergonomics in the workplace.

The design of ergonomic workplaces and jobs leads to reduced injury and absenteeism rates, while improving productivity, quality and reliability of the company. The result is the sensitive improvement of the wealth of both employees and company.

The Occupational Health and Safety Administration (OSHA) requires companies to perform the job hazard analysis for the identification of hazards before they occur. The analysis of existing or potential job hazards is necessary to determine the best way to perform the job or to reduce or eliminate the hazards (ISO 12100-1:2003 + A1:2009 2009).

The International Standards Organization (ISO) provides information for designers, employers, employees and safety professionals involved in the design of workplace, job and product, to promote the safety culture in workplaces. The ISO 11228 series of International Standards, the ISO 11226 (2000) and their application document, the ISO/TR 12295 (2014), establish ergonomic recommendations for different manual handling tasks and working postures. In particular, these standards provide the ergonomic risk assessment methods and the ergonomic approach to eliminating or reducing the risk of biomechanical overload.

In particular, the ISO 11228 series address ergonomics for manual handling activities as lifting and carrying (ISO 11228-1 2003) and handling of loads at high frequency (ISO 11228-3 2007). The ISO 11226 is the International Standard for the evaluation of static working postures, which provides the limits for static working postures with body angles and duration, and the minimal external force exertion. The ISO 11228 series and the ISO 11226 include the detailed risk assessment methods for hazard identification, risk estimation and risk evaluation. Finally, the ISO/TR 12295 defines additional criteria and details for applying the risk assessment methods proposed in the original standards of the series.

The aim of these standards is to address the application of the ergonomics principles to workplace design and re-design. When recommended limits are not satisfied, corrective measures and controls should be taken to prevent the manual task, or to modify the working conditions and to provide auxiliary equipment for the ergonomic risk reduction.

The OSHA 3071 (2002), the BS OHSAS 18001 (2007) and the ISO 45001 (2016) standards suggest a stepwise procedure for the job hazard analysis. In particular, the ISO 45001 is an as yet unpublished Occupational Health and Safety Management Standard analogue to the OHSAS 18000 standards, that will replace the BS OHSAS 18001. Such standards recommend the use of control methods for the elimination or the reduction of the identified hazards. Control methods include engineering controls, administrative controls and Personal Protective Equipment (PPE). Engineering controls physically change a machine or work environment to prevent employee exposure to the hazard. If engineering controls are not feasible, the OSHA 3071 encourages the adoption of administrative controls, e.g., written operating procedures, work permits, and safe work practices. Finally, PPE is any protective equipment designed to protect the worker from injury. Protective equipment is an acceptable control method when engineering controls do not totally eliminate the hazard or when safe work practices do not provide sufficient additional protection. Nowadays, no PPE is available to reduce the risk factors for WMSDs.

Many industries adopt ergonomic solutions in their facilities as a mean to reduce their workers' WMSD injury risks and their associated workers' compensation costs and turnover.

The aim of their interventions is to reduce the ergonomic risk factors and the chance of injury through the reduction of physical demands and the elimination of unnecessary movements. These ergonomic solutions include the revision of the existing equipment to meet the ergonomic principles, the re-design of the work practices and the purchase of ergonomic tools and machinery.

The elimination of hazards, or the reduction of risk when the elimination is not possible, is the first objective of safety strategies. Risks are eliminated or avoided by adopting protective and preventive measures. The ISO Standard 12100-1 (2003) for the design of safe machinery defines the "3-step method" to address the elimination of hazards and the reduction of risk:

1. Inherently safe design measures;
2. Safeguarding and possibly complementary protective measures;
3. Information for use about the residual risk.

Similarly, job activities, tasks and the work environment should be designed to limit the exposure to ergonomic risk factors by taking preventative measures in order of priority. The OHSAS 18001, the OSHA 3071 and the draft version of the ISO 45001 define the hierarchy of controls for achieving reduction in occupational health and safety risks. The following Figure 2.2 summarizes the steps of the hierarchy.

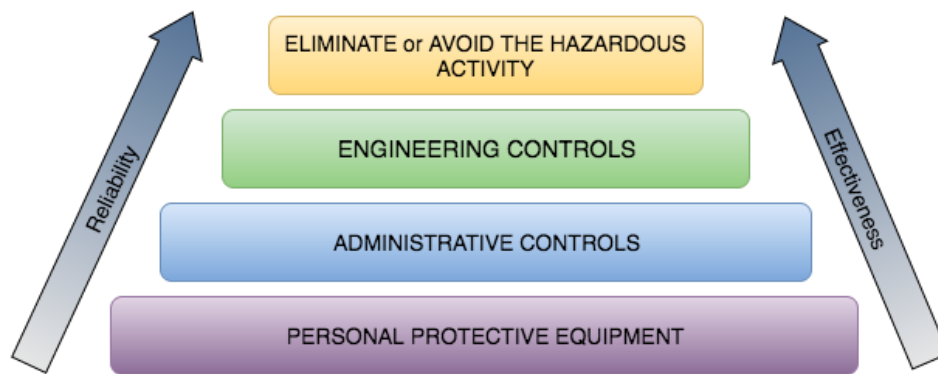

Figure 2.2 Hierarchy of control measures.

The most effective protective measure is to eliminate the hazards without shifting them elsewhere. Elimination is the total removal of the hazards and making all the possible safety and health threats impossible. If the hazard is not removed, high-risk activity should be avoided or substituted with another that poses a lower risk to workers' safety and health. The second step of the hierarchy suggests the use of engineering controls that implement physical change to the workplace for the elimination or reduction of the hazard on the job. This control measures interrupt the connection between the hazards and the workers, acting as a barrier. Examples of engineering controls are the adoption of devices that support lifting operations to limit force exertion or the re-design of a workspace to eliminate excessive reach and enable working in neutral postures. Administrative controls are effective protective measures to reduce or eliminate the exposure to a hazard. These controls include organizational measures, procedures, instructions and work practice controls when engineering controls cannot be adopted. An example of administrative control is job rotation. This work practice minimizes the duration of repetitive movements and awkward postures, enhancing the rotation between jobs that use different muscle groups. Training of the workers and authorization are further administrative controls for the reduction of the risk. The last step of the hierarchy suggests the use of PPE for the reduction of the exposure to ergonomic risks when the previous controls cannot be implemented. Examples of PPE are anti-vibration gloves for task with vibrating tools, or earplugs and hearing protection devices for working in noisy environment. Given the nature of manual handling activities, no PPE is available to protect workers from the risk of biomechanical overload. Engineering and administrative controls help in reducing the ergonomic risk factors as force, repetition and posture of manual handling. Further factors of a strictly personal nature contribute to the risk for WMSDs. These individual risk factors include the state of health, the life style and the former experiences of the worker. Several ISO Standards establish principles to reduce the exposure to individual-related risk factors. The aim of these Standards is to ensure harmony between people and the work environment. The ISO has quantified the size and shape of working people to optimize the technological design of the workplace (ISO 7250-1 2008, ISO 7250-2 2010, ISO

7250-3 2015). Based on current ergonomic knowledge and anthropometric measurements, the International Standard ISO 14738 (2002) defines the anthropometric requirements for the design of workstation at machinery. This International Standard specifies the body's space requirements for equipment during normal operation in sitting and standing positions. However, priority should be given to measures that protect collectively over individual measures. Furthermore, effectiveness and reliability of the control measures reduce with the hierarchy of controls (Figure 2.2). When the hazard elimination is not possible, engineering controls are the preferred measure to protect the workers from exposure to hazards.

## 2.1.2 Review of technical solutions for ergonomics

This section presents a brief review on recent innovative engineering controls and technical solutions for the ergonomics of manual workers in several industries (e.g., construction, agriculture, meat-processing, retail and personal service assistance). The proposed engineering controls are included in the online Solutions Database (<http://safetyengineering.din.unibo.it/en/banca-delle-soluzioni>), a research project for the development of informative documents to support and update the companies about available automated solutions and tools improving ergonomics in occupational environment characterized by manual material handling, repetitive work, awkward and static postures. Before introducing the review of technical solutions for ergonomics, the following Section 2.1.2.1 presents the aims and the contents of the Solutions Database Project.

### 2.1.2.1 The Solutions Database Project

The introduced technical and technological solutions for reducing the risk of manual material handling have been the focus of the Solutions Database Project. The Solutions Database Project. *Solutions Database* is a research project for the development of informative documents to support and update the companies about available automated solutions and tools improving ergonomics in occupational environment characterized by manual material handling and repetitive work, and for activities in confined space. The study focuses on occupational safety and health issues of several industries, e.g. oil and gas industry, pharmaceutical, food processing and construction industry. The project is in co-operation with the Regional Occupational Safety and Health Agency and the Regional Firefighters Agency of Emilia Romagna. The Department of Industrial Engineering of the University of Bologna coordinates the research activities together with the regional authorities, fire and rescue professionals and occupational safety and health specialists.

The result is the creation of a free access online database (Figure 2.3), containing informative documents and aiming to address companies towards the introduction of automated solutions for the replacement of workers during high-risk activities in confined spaces and improving

the ergonomics of postures during work, repetitive movements of the upper-limbs and manual material handling (<http://safetyengineering.din.unibo.it/en/banca-delle-soluzioni>).



Figure 2.3 Webpage of the Solutions Database

The aim of the Project is to provide a useful tool for companies and to investigate the state of the art on proper equipment and devices for the risk elimination or reduction, as requested by the Italian legislation in force on occupational health and safety (D.Lgs. 81/2008). The Solution Database does not have commercial purposes. The Project has been developed thanks to a funding from the Emilia Romagna Region to the AUSL Bologna (fondi sanzioni D.Lgs. 758 anno 2011 delibera di Giunta Regionale 2092/2012).

#### 2.1.2.1.1 Research Methods and Criteria

The technical solutions held in the Solutions Database were found through several research channels, as the scientific literature, the reports from the surveillance activities of the Occupational Health and Safety Surveillance Services and the international search engines. The researches have been performed by keywords, aiming to recall the investigated activities and industries. The research aimed to identify the state of the art on automated solutions for activities in confined spaces and to avoid the occupational disorders and illnesses outset due to the biomechanical overload of the musculoskeletal system. Each solution is published in the database as a technical factsheet, containing the description, the picture and the technical characteristics of the proposed device (Figure 2.4).

SOLLEVATORE PER LASTRE E PANNELLI PESANTI

ATTIVITÀ

**DESCRIZIONE**  
Sollevamento di pannelli e lastre pesanti e ingombranti.

CARATTERISTICHE DELLA SOLUZIONE TECNICA



MOVIMENTAZIONE DI BLOCCHI E PANNELLI PESANTI  
  
**EDILIZIA**

**MODALITÀ D'USO**  
I sollevatori sono dotati di forche sulle quali viene appoggiato il pannello. Il dispositivo è così in grado di sollevare e abbassare le lastre facilmente, anche in modo motorizzato. Esistono carrelli di geometria simile ma con dispositivo di sollevamento manuale. Le rotelle inoltre permettono anche lo spostamento orizzontale dell'intero dispositivo.

**CARATTERISTICHE TECNICHE**  
Si riportano di seguito le caratteristiche di un generico sollevatore meccanico: Capacità: 400 kg - Altezza delle forche: da 85 a 850 mm - Lunghezza delle forche: 650 mm - Altezza complessiva: 1060 mm - Spessore: 590 mm - Lunghezza complessiva: 1040 mm - Peso: 75 kg.  
Si riportano di seguito le caratteristiche di un generico sollevatore motorizzato: Capacità: 1000 kg - Altezza delle forche: da 85 a 1600 mm - Lunghezza delle forche: 1140 mm - Altezza complessiva: 1980 mm - Spessore: 780 mm - Lunghezza: 1720 mm - Peso con batteria: 410 kg.

**COSTO**  
Sollevatori meccanici: 700 - 1300 € circa.  
Sollevatori motorizzati: 2500 - 3200 € circa.

**[bancadelle soluzioni]**  
Per avere informazioni su come trovare questa soluzione, visita il sito [safetypengineering.dn.unibo.it/banca-delle-soluzioni/](http://safetypengineering.dn.unibo.it/banca-delle-soluzioni/)  
CONOSCI O PRODUCI ALTRE SOLUZIONI? COME QUESTA? SCRIVI A [dn.safetypengineering@unibo.it](mailto:dn.safetypengineering@unibo.it)



SOLUZIONI  
ERGONOMICHE

Figure 2.4 Example of solution contained in the Solutions Database

The proposed collection does not mean to be a complete list, but it represents the first version of a living document, showing the actual state of the technical development. In particular, the included solutions are only the one that avoid the human access in confined spaces (Section Confined Spaces), and that guarantee ergonomics and safety of manual work (Section Ergonomics - Biomechanical overload).

The following Sections from 2.1.2.2 to 2.1.2.6 introduce technological and technical solutions for ergonomics. The proposed engineering controls are prototypes and products of the research on the different industries: construction, agriculture, meat processing, retail and personal service assistance. Commercial solutions are included in the online Solutions Database. Both the solutions in this chapter and the solutions in the Solutions Database are not intended to be an exhaustive list.

### 2.1.2.2 Construction Industry

Construction workers perform physically demanding tasks as lifting, pulling, lowering, holding and carrying construction materials. Manual material handling of construction materials involves strenuous movements with heavy loads and awkward postures. These workers are exposed to high risk of painful strains and soft tissue injuries and disorders affecting muscles, tendons, ligaments, discs, cartilage and nerves. The American National Institute for

Occupational Safety and Health (NIOSH) reported that the number of back injuries in the United States is 50% higher than the average for all other US industries (Aniello 2016). Many construction workers admit that they continue to work while being injured or feeling in pain, and causing a sensible reduction in productivity. These behaviors may lead to disabling injuries while on the job with average disability duration of 46 days for injured worker (Courtney, Matz & Webster 2002). Consequently, the construction industry faces the possibility of labor shortage in the next years (Bernold, Altobelli & Taylor 1992, Morales, Herbizman & Najafi 1999, Hasegawa 2006). An interesting option to solve these problems is to integrate manual construction work with high technology and automation (Kumar, Prasanthi & Leena 2008). Current research has seen the development of several robots for automatic assembly of civil structures in construction industry (Balaguer, Abderrahim 2008). Japanese construction companies are leaders in the development and application of robots in construction (Bernold, Altobelli & Taylor 1992, Morales, Herbizman & Najafi 1999).

The engineering controls in Table 2.1 are innovative automated solutions for typical tasks in construction industry, as brick assembly, painting and finishing of walls and floors.

Table 2.1 **Engineering controls for construction industry**

Engineering control	Task	Reference	Year
Robot for brick assembly of walls	Brick assembly of walls	Bernold Gambao et al.	1992 1997
Research on machines for brick assembly of floors	Brick assembly of floors	Burdorf et al.	2007
Robotic tile placement	Tile placement	King et al.	2014
Machine for installation of heavy duty glasses and sheets	Installation of heavy materials	Yu et al. Gil et al.	2007 2011
Façade cleaning system	Surface finishing	Gambao et al.	2008
Interior wall painting robot	Painting	Sorour et al.	2011
High-rise building construction technology	Building construction	Maeda	1994
Wearable robot for assisting carpentry workers	High-demand tasks	Naito et al.	2007

The engineering controls in Table 2.1 replace or assist workers during manual handling of construction materials. As an example, the two devices in Figure 2.5 and Figure 2.6 perform the automatic brick placement and assembly for walls and floors.

The bricklaying machine in Figure 2.5 catches and presses the brick into place accurately. A stepper motor control program controls the system, which is responsible for the placements of the bricks and the control of the brick gripper. The roadmaker in Figure 2.6 prepares the sand bed and manually maneuvers the hydraulic clamp to the exact spot.

Several engineering controls in Table 2.1 are not commercialized. Other solutions, as the building construction technology, are available, but the high cost prevents their adoption in common construction sites. Further commercial controls are included in the open access



Solutions Database (<http://safetyengineering.din.unibo.it/en/banca-delle-soluzioni/ergonomia/soluzioni-tecniche-per-lergonomia/edilizia>), together with other useful information as the manufacturer and the cost.

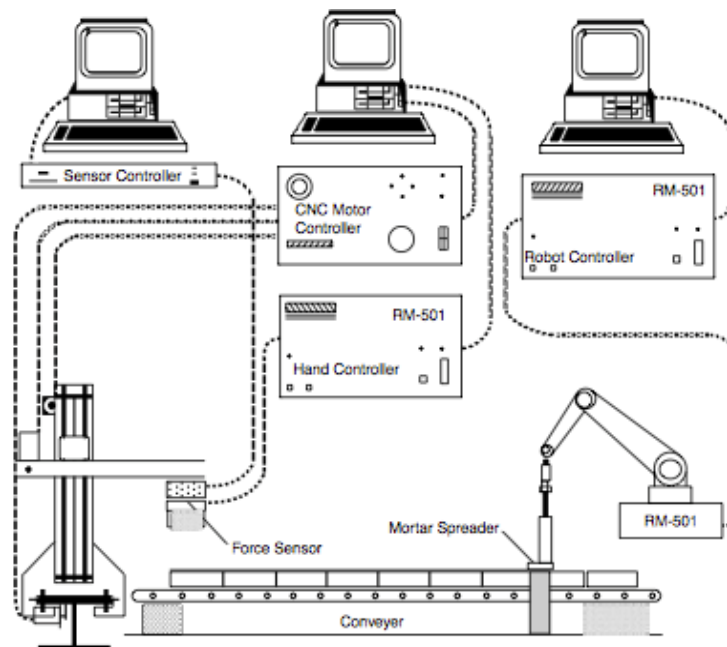

Figure 2.5 Schematic of prototype masonry system (Bernold, Altobelli & Taylor 1992).



Figure 2.6 Machine with hydraulic clamp for brick assembly of floors (Burdorf et al. 2007).

### 2.1.2.3 Agriculture

Farming activities involve physically demanding tasks that cause WMSDs, severe long-term pain and physical disabilities (Basher et al. 2015). These tasks include lifting and carrying heavy loads, repetitive motions with the upper part of the body and assuming awkward postures while grasping and selecting fruits and vegetables (Osborne et al. 2012). Automated farming technology helps farmers and manual workers in agriculture to perform strenuous activities and high-demanding tasks. Several agricultural processes have seen the introduction of automation and the replacement of human labor with automated technologies for agriculture, e.g., seeding, ploughing, planting and trimming. Research on automation for agriculture is studying robotic solutions to control autonomous agricultural processes by means of interconnected tractors, gear motors, sensors, PLCs and conveyors (Dhivya, Infanta & Chakrapani 2012). The engineering controls in Table 2.2 are innovative automated solutions for typical high-demand tasks as treating, harvesting, inspecting, selecting and grading in agriculture.

Table 2.2 Engineering controls for agriculture

Engineering control	Task	Reference	Year
Spraying and fertilization application	Treating	Belforte et al.	2006
		Sammons et al.	2005

Harvesting robot for apples	Harvesting	De-An et al.	2011
		Guo et al.	2010
Harvesting robot for strawberries	Harvesting	Feng et al.	2012
		Hayashi et al.	2010
Harvesting robot for cherries	Harvesting	Tanigaki et al.	2008
Harvesting robot for radicchio	Harvesting	Foglia, Reina	2006
Harvesting robot for cucumbers	Harvesting	Van Henten et al.	2009
Vision inspection and sorting system for multiple food products	Inspection	Feng, Qixin	2004
		Khojastehnazhand et al.	2010
		AL-Marakeby et al.	2013
Vision inspection and sorting system for potatoes	Inspection	Jin et al.	2009
		Hassankhani et al.	2012
		Razmojooy et al.	2012
Vision inspection and sorting system for nectarines	Inspection	Font et al.	2014
Vision inspection and sorting system for citrus fruits	Inspection	Lorente et al.	2013
		Teoh, Mohd Syaifudin	2007
		Nur et al.	2009
		Kohno et al.	2011
Vision inspection and image processing system	Inspection and grading	Hasankhani et al.	2012
		Cubero et al.	2014a,
		Tomas, Ganiron	2014b
		Roscher et al.	2014
Fruit grader machine	Grading	Ukey, Unde	2011
Wearable mobile sensor platform	Grading	Aroca et al.	2013

The engineering controls in Table 2.2 replace or assist workers during manual handling of loads in agriculture. As an example, the two devices in Figure 2.7 and Figure 2.8 perform the automatic harvesting of different types of fruit.



Figure 2.7 Apple-harvesting robot (De-An et al. 2011).



Figure 2.8 Strawberry-harvesting robot (Hayashi et al. 2010).

The robotic device in Figure 2.5 consists of a manipulator, an end-effector and an image-based vision servo control system for harvesting apples. The success rate of the apple-harvesting robot is 77%, while the average harvesting time is approximately 15 s per apple. Similarly, the strawberry-harvesting robot in Figure 2.8 consists of a cylindrical manipulator, an end-effector, a machine vision unit, a storage unit and a travelling unit. The machine vision unit detects the target fruit at a rate of 60%, while the successful harvesting rate on ripe fruits is between 34.9% and 41.3%. The average harvesting time to detect, grasp and transfer the fruit to a tray is 11.5 s.

The engineering controls in Table 2.2 are prototypes and products of the research on technologies for manual handling in agriculture. Several commercial controls are included in the open access Solutions Database (<http://safetyengineering.din.unibo.it/en/banca-delle-soluzioni/ergonomia/soluzioni-tecniche-per-lergonomia/agricoltura>), together with other useful information as the manufacturer and the cost.

#### 2.1.2.4 Meat Processing

Work activities in the meat processing industry are both technically and physically demanding. Meat processing workers perform a wide range of tasks, involving manual handling of heavy loads at high frequency. Common activities include lifting, moving, turning and twisting heavy carcasses among the workstations. Other tasks involve laborious and frequent movements to cut the meat, whilst holding the heavy carcasses. Meat processing work requires the workers to keep up with the high speed of processing lines. Such repetitive movements are a common cause of WMSDs. Additional risk factors include the work environment, which is characterized by noise, humidity, cold and offensive odours. These conditions make the meat processing industry physically and emotionally demanding. Consequently, slaughterhouse work is not an attractive option for prospective employees, particularly young people. Employment policies and practices of this industry result in serious physical and mental harm to meat processing workers, preventing them from reporting

injuries or drawing attention to unsafe working conditions. Furthermore, several workers are recent immigrants and face additional economic and social pressures increasing their vulnerability in the workplace (Monforton 2013). Despite occupational injuries and illnesses have declined over the past decade, the meat and poultry industry still has one of the highest rates of injury and illness of any industry. As a consequence, the meat processing is one of the most hazardous industries, as it poses a serious risk to workers' safety and health (United States Government Accountability Office 2005). To improve the working environment and hinder the potential insufficiency in the labor force, the meat processing industry is automating the most labor-intensive parts of the work process (Purnell, Caldwell 2012, Clarke, Nielsen & Madsen 2014).

Automated meat processing robots reduce arduous repetitive work, requiring manual workers to replace heavy activities with less-intensive tasks, e.g., planning and controlling the new technology (Nielsen, Fertin & Christensen 2005, Barbut 2014). Furthermore, the increasing international competition is pressuring the meat processing industry to automate the meat process and develop more efficient production methods. A recent study on the European meat industry reveals that the per capita meat consumption has stabilized in the last 20 years (Kanerva 2013). This static overall consumption increases the pressure on the meat processing companies to adopt more efficient production methods, e.g., automated technology. At the same time, automation offers consistent benefits for safety and hygiene of the meat processing work, providing higher process controllability and better working conditions (Wadie et al. 1995, Purnell, Caldwell 2012, Purnell, Grimsby Institute of Further and Higher Education 2013). For example, the reduction of manual handling and the more efficient tool sterilization in the clean slaughter line reduce the cross contamination between carcasses, improving the food hygiene and safety.

Robot technology is widely used in manufacturing industry, when products are well-defined and properly designed. Furthermore, the high investments in automation require industries with high production volumes to ensure a reasonable payback time. The meat industry is characterized by raw materials with not uniform features. Pork, poultry and lamb slaughtering are fully or partially automated, e.g., poultry lines work at high speeds, while the lamb production is partially automated (Madsen, Nielsen 2002, McMurray 2013). Nevertheless, several projects failed after trying to automate the whole beef slaughtering process (Purnell 1998, Madsen, Nielsen 2002), i.e., fully automatic slaughtering is more complex in beef and pork production, due to greater dimensions and weight of the carcasses. Flexible automation is an interesting option for the bovine, ovine and porcine industry. Previous researches on programmable manipulators and general-purpose robots performing multiple tasks showed high success rates and return on investment with short payback (Templer, Nicholls & Nicolle 1999, Botti, Mora & Regattieri 2015). However, highly skilled and commercially aware companies are needed to commercialize the research successfully.

The engineering controls in Table 2.3 are examples of automated solutions supporting meat-processing workers in typical high-demand tasks as cutting and packing meat.

Table 2.3 Engineering controls for meat processing

Engineering control	Task	Reference	Year
Cutting robot	Cutting	Templer et al.	1999
		Bogue (KUKA, FANUC)	2008
Pork ham automatic deboning robot	Deboning	Kusuda (Mayekawa Manufacturing Co. Ltd)	2011
Meat slice packing system	Packing	Kusuda (Nantsune)	2011
Processed meat packing system	Packing	Templer et al.	1999
		Wolf	1999
		Dickerson et al.	2005
		Madsen, Nielsen	2002
		Nielsen et al.	2005
		Madsen et al.	2006
Fully automated slaughtering	Slaughtering	Clarke et al.	2014
		Nielsen et al.	2014
		Barbut	2014

The engineering controls in Table 2.3 replace or assist workers performing manual tasks in meat processing. The robot in Figure 2.9 is a six-axis modular robot designed for high speed, application flexibility and repeatability. Equipped with knives and a vision system, the robot is designed to perform cutting operations in slaughterhouse environment. Automation is widely adopted in slaughter and boning operations for pigs, poultry and lambs. The beef industry is more fragmented and raw materials are not uniform. Consequently, the fully automation of beef slaughter is a future challenge for the meat-processing industry. Madsen, Nielsen and Mønsted (2006) have designed the layout of an automated slaughter line of the future (Figure 2.10).



Figure 2.9 FANUC M-710i robot (De-An et al. 2011).

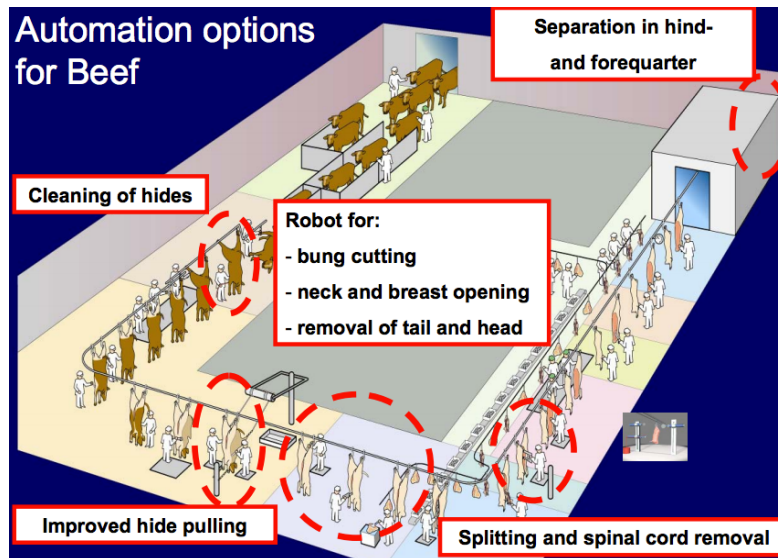

Figure 2.10 Automated slaughter line of the future (Madison, Nielsen and Mønsted 2006).

The increased automation of the future slaughter line will impact on the current role of meat-processing operatives. Workers will perform less demanding activities, compared with the activities performed in traditional slaughter lines. These activities include the supervision of the automatic machinery in order to check the quality of products and to ensure short downtimes. Despite the promising benefits of partially or fully automated slaughter lines, individual companies and industry organizations seem too small to sustain the high investment in automated technology.

Many engineering controls in Table 2.3 are prototypes and products of the research on technologies for manual handling in the meat-processing industry. Further commercial controls are included in the open access Solutions Database (<http://safetyengineering.din.unibo.it/en/banca-delle-soluzioni/ergonomia/soluzioni-tecniche-per-lergonomia/lavorazione-delle-carni>), together with other useful information as the manufacturer and the cost.

#### 2.1.2.5 Retail

Several activities in the retail industry expose workers to high risk from developing WMSDs. Biomechanical and environmental risk factors contribute to the development of WMSDs. The first include physically demanding tasks involving manual handling, awkward and static postures, over-exertion, repetition, and contact stress. The latter comprise the exposure to hot and cold temperatures or to vibration. Furthermore, psychosocial risk factors related to work organization and interpersonal relations contribute to the increment of muscle tension and aggravate biomechanical strains (EU-OSHA 2007). Typical activities that expose retail workers to these risk factors include bending or twisting torso while lifting or holding heavy objects, working with wrists in a bent position, moving hands below the waist or above the shoulders, performing quick wrist motion while scanning, lifting items rather than sliding them

over the scanner and using tools that require a pinch grip or a single finger. OSHA recommends employers use engineering and administrative techniques, where feasible, as the preferred method of dealing with ergonomic issues in retail grocery stores (OSHA 2004a). The OSHA publication 3192-05N (OSHA 2004b) provides some ergonomic solutions for grocery stores, suggesting changes to equipment, work practices, and procedures that can address ergonomic risk factors, help control costs, and reduce employee turnover. Focusing on engineering controls, the following Table 2.4 reports some interesting solutions supporting retail workers in typical high-demand tasks as moving products on checkout counters, replenishing shelves in retail grocery stores and picking products from the warehouse.

Table 2.4 Engineering controls for retail

Engineering control	Task	Reference	Year
Shelf self-replenishment	Shelf replenishment	WITRON	2016b
Ergonomic dynamic picking system	Order picking in the warehouse	WITRON	2016a
Self shopping device	Self shopping	Datalogic	2016b
Re-designed checkout counter	Scanning products at the checkout	Rodacki, Vieira	2010
		Draicchio et al.	2012
		Datalogic	2016a

The engineering controls in Table 2.4 replace or assist workers performing manual tasks in retail. As an example, the SRS (Shelf Replenishment System) by WITRON is an automatic shelf service for filling and replenishment control of the shelves in the stores of food retailing.

The items in the SRS are carried and moved by means of a handling equipment with shuttles (Figure 2.11). The shuttles transport the goods through a replenishment aisle that is directly integrated into the shelf. The shelf inventory is automatically captured using a scanner, which is located on the shuttle, determining the optimal design replenishment volume in the shelf directly.

While the implementation of bar-code scanners for checkout has improved productivity and efficiency, the physical demands of the scanning action affect the workers' health. The rapid pace needed to maintain product flow requires cashiers to move their wrists back and forth up to 600 times per hour, handling the products on the checkout counter (Sanford et al. 2008). The Jade™ X7 portal scanner is a data collection device designed by Datalogic (Datalogic a). The portal detects items placed in any orientation on a moving checkstand belt. The items pass through scanning arches that contain an advanced imaging technology for the product identification. The arches read bar codes and visually recognize items at higher speed than with traditional checkout configuration.





Figure 2.11 WITRON SRS Self Replenishment System (WITRON b).



Figure 2.12 Jade™ X7 portal scanner (Datalogic a).

The portal scanner in Figure 2.12 reduces checkout waiting times, matching the shoppers' objectives and reducing the physical demand of work at the checkout counter.

Some of the engineering controls in Table 2.4 are not commercialized. Other solutions, as SRS or the picking system by WITRON, are available, but the high cost prevents their adoption in small and medium size retail stores. Further commercial controls are included in the open access Solutions Database (<http://safetyengineering.din.unibo.it/en/banca-delle-soluzioni/ergonomia/soluzioni-tecniche-per-lergonomia/gdo>), together with other useful information as the manufacturer and the cost. Furthermore, the Solutions Database includes equipment and devices for manual handling activities shared with different industries, as vacuum lifters for lifting loads in retail and manufacturing.

#### 2.1.2.6 Personal Service Assistance

Personal assistance services deal with the personal care and the needs of elderly and disabled adults at home. Home care providers, nursing assistants and other paid domestic workers help care recipients to remain independent, providing the support from the hospital into their home. The services provided by home care providers include help to perform activity of daily living as bathing, dressing and eating.

WMSDs and injuries, such as strain and sprain, are prevalent problems for those who provide assistance services in the home (Galinsky, Waters & Malit 2001, Kim et al. 2010). Hazards in the home that may impact on WMSDs include poor task ergonomics, physical barriers and lack of space or equipment to get the job done. In their study, Faucett, Kang and Newcomer (2013) have demonstrated significant associations for WMSDs across several domains of personal assistance work in the home, including psychosocial (e.g., social support), organizational (e.g., unpredictable work hours and rest breaks), and physical risk factors (e.g., bending and strenuous activities). Their research confirms the multidimensional nature of WMSDs, stressing the importance of a solid collaboration between care providers and recipients.

Engineering controls, as mechanical lifting equipment, and administrative controls, as training programs, strengthen such collaboration, by protecting care providers from injury, reducing lost workdays and absenteeism and improving the quality of care delivered to recipients (Collins, Nelson & Sublet 2006).

The engineering controls in Table 2.5 are innovative solutions supporting care providers in typical high-demand tasks as moving the patients from the bed to the wheelchair.

Table 2.5 **Engineering controls for personal service assistance**

Engineering control	Task	Reference	Year
Assistive robot arm	Multiple tasks	Bolmsjö, Olsson, Lorentzon	2002

		Balaguer et al.	2005
		Correal et al.	2006
		Huete et al.	2012
Tele-operated service robot	Multiple tasks	Van Osh et al.	2014
Intelligent home system	Multiple tasks	Jung et al.	2005

Conventional devices for home care assistance, as care and lift systems, are usually installed in houses and typically perform one single task. The research on home care device is investigating the introduction of dynamic and mobile items, as robots, to support patients in multiple tasks, e.g., eating, washing and moving from the bed to the wheelchair. The ASIBOT robot in Figure 2.13 is an assistant manipulator designed to help elderly and disabled adults in their homes.



Figure 2.13 The robot assisting a disabled user (Correal et al. 2006).

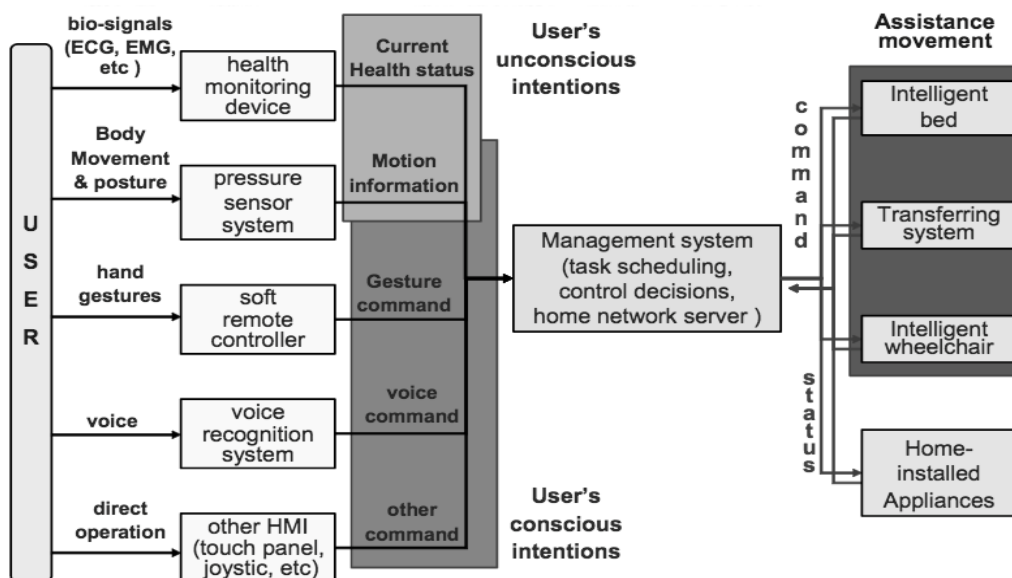

Figure 2.14 Block diagram of the Intelligent Sweet Home (Jung et al. 2005).

The robot in Figure 2.13 includes a docking mechanism to connect its body to the wall or a wheelchair, and a gripper. The modular structure allows ASIBOT to fit into any environment,

moving among the rooms, up or downstairs, and from/to the wheelchair. For this purpose the environment is equipped with serial docking stations, which make possible the transition of the robot from one location to another (Correal et al. 2006, Huete et al. 2012).

A parallel research path is investigating the cooperation of static and dynamic home care devices to design smart houses. These assistive systems integrate devices for movement assistance, devices for continuous monitoring of care recipients and interfaces for controlling home-installed devices. The intelligent Sweet Home developed by Jung et al. (2005) is an example of a smart home system. This smart house includes an intelligent bed, an intelligent wheelchair and a transferring system (Figure 2.14). In particular, the intelligent bed actively helps disabled users by means of a robotic manipulator, while the intelligent wheelchair autonomously finds paths to drive the user to the destination. Finally, the mechatronic transfer system consists of a transfer robot with a mobile base, a lifting mechanism and a sling to hold the patient. The movement of these three intelligent devices is controlled by the central management system.

The engineering controls in Table 2.5 are prototypes and products of the research on technologies for the reduction of the risk of biomechanical overload. Further commercial controls are included in the open access Solutions Database (<http://safetyengineering.din.unibo.it/en/banca-delle-soluzioni/ergonomia/soluzioni-tecniche-per-lergonomia/assistenza-domiciliare>), together with other useful information as the manufacturer and the cost.

This brief review of innovative engineering controls for the reduction of the risks of biomechanical overload does not include solutions for manufacturing and assembly work. Autonomous robots for assembly work are widely adopted in such industries. In particular, small parts assembly lines are typically fully manual or fully automated. However, several companies have reported high levels of dissatisfaction with automation investments in the past, due to the inflexibility of these facilities in terms of reflecting changing market conditions (Bley et al. 2004). Hybrid assembly lines involve close cooperation between humans and automated machinery. The effective cooperation is possible when the production requirements meet the ergonomic principle for worker health and safety. Previous studies have shown that successful introduction of industrial robots in a hybrid assembly line demands several requirements, as that the robot makes only a small change to the existing assembly practice, and that the solution combines the individual strengths avoiding the individual limitations of manual assembly and robotic assembly (Hedelind, Kock 2011).

ABB has developed the robot system in Figure 2.15, aiming to meet the requirements for effective cooperation between human workers and industrial robots.



Figure 2.15 ABB dual-arm robot.

The robot consists of a dual-arm robot with a very small footprint, allowing it to fit into the manual station with the station size requirements. The robot is intrinsically safe, as it can be integrated into the assembly line without any additional protections (Kock et al. 2011).

For a detailed list of commercial engineering controls for assembly and manufacturing, see the dedicated section in the open access Solutions Database (<http://safetyengineering.din.unibo.it/en/banca-delle-soluzioni/ergonomia/soluzioni-tecniche-per-lergonomia/linee-assemblaggio>).

## 2.2 ADMINISTRATIVE CONTROLS FOR ERGONOMICS

The health and safety regulations and guidelines on occupational safety require to eliminate the risk or to reduce the exposure by means of control measures, following the hierarchy in previous Figure 2.2. This section introduces three novel administrative controls for the control of ergonomic risks in industry.

Specifically, administrative controls, or work practice controls, involve changes in the work organization or in work procedures, e.g., organizational measures, training of workers, and job schedules. The regulations on workplace health and safety recommend the use of administrative controls if engineering controls are not available.

The following controls are based on three different methods to reduce the ergonomic risk of manual work and improve workers' health and safety in industry:

- Proper design of the plant layout (Section 2.2.1)
- Human resource management (Section 2.2.2)
- Proper utilization of tools and equipment (Section 2.2.3)

The first administrative in Section 2.2.1 is a mathematical model for the design of lean processes in hybrid assembly lines. The aim was to provide an effective, efficient assembly line design tool that meets the lean principles and ergonomic requirements of safe assembly work. The second administrative control in Section 2.2.2 adopts job rotation as a measure to minimize the duration of repetitive movements and awkward postures, enhancing the rotation between jobs that use different muscle groups. Finally, the administrative control in Section 2.2.3 aims to reduce the vibration exposure of construction workers while improving their performances through the proper utilization of drilling tools and equipment.

## 2.2.1 Ergonomic design for lean manufacturing: A mathematical model for hybrid assembly lines

Lean manufacturing is a production method that was established in the wake of the Japanese Toyota Production System and rapidly spread in the worldwide manufacturing industry. Lean characteristics combine waste reduction with defect-free production and standardization. The primary goal of lean thinking is to improve profits and create value by minimizing waste, with limited resources. The principal characteristics of lean thinking include Just-in-time (JIT) practices, work-in-progress (WIP) reduction, improvement strategies, and work standardization. The primary goal of lean production is to reduce costs and increase productivity by eliminating waste. Anything other than the minimum amount of equipment, materials, parts, space and employee time necessary to produce the required products is waste (Suzaki, 1987). Seven types of waste negatively affect the productivity of manufacturing companies: correction, overproduction, motion, material movement, waiting, inventory and processing. The presence of all seven types of waste negatively impacts the product lead-time, cost and quality (Walder et al., 2007). Several industries and manufacturing processes, from the automotive industry to the service industry, integrate their production strategies with lean thinking principles, aiming to improve productivity and quality through cost reduction.

This section introduces a novel mathematical model to design lean processes in hybrid assembly lines. The aim was to provide an effective and efficient assembly line design tool that meets the lean principles and ergonomic requirements of safe assembly work. Given the production requirements, product characteristics and assembly tasks, the model defines the assembly process for hybrid assembly lines with both manual workers and automated assembly machines. Each assembly line solution ensures an acceptable risk level of repetitive movements, as required by current law.

This model helps managers and practitioners to design of hybrid assembly lines with both manual workers and automated assembly machines. The model was tested in a case study of an assembly line for hard shell tool cases. Results show that worker ergonomics is a key parameter of the assembly process design, as other lean manufacturing parameters, e.g. takt time, cycle time and work in progress.

### 2.2.1.1 The effects of lean thinking on ergonomics and human factors

Previous studies have widely investigated the impact of human factors and worker behaviours on company performance and expected outcomes (Wygant et al., 1993; Resnick and Zanotti, 1997; Shikdar and Sawaqed, 2004; Dul et al., 2004; Othman et al., 2012; Xu et al., 2012). Based on such principles, the applied science of ergonomics analyses the importance of workstation and work process design and the effects on worker safety and health. Past and recent studies have widely discussed how ergonomics can optimize human performance and

overall work system performance (Dul and Neumann, 2009). The design of ergonomic workplaces and jobs reduces injury and absenteeism rates, while improving productivity, quality and reliability (Botti et al., 2014). Previous studies have shown that musculoskeletal disorders (MSDs) lead to significant loss of productivity due to higher absenteeism and injury rates (Rajabalipour Cheshmehgaz et al., 2012).

Ergonomics and production requirements are key elements of the lean planning process. The integration of ergonomic principles in the lean process plays a leading role in the successful implementation of the lean strategy. Past studies have widely investigated the impact of lean thinking on worker health and safety (Smith, 2003; De Treville and Antonakis, 2006; Kester, 2013; Yusoff et al., 2013). Several studies have investigated the potential correlation between specific lean practices (e.g., waste reduction and continuous flow) and ergonomics, occupational health and related risk factors (Adler et al., 1997; Jackson and Mullarkey, 2000; Conti et al., 2006; Sprigg and Jackson, 2006). Furthermore, high-strain jobs have a high risk of musculoskeletal disorders and psychological load, leading to company costs and losses (Nunes and Machado, 2007).

A parallel research path aims to identify how manufacturing industries can improve their lean production strategies through industrial robot automation (Bowler and Kurfess, 2010; Hedelind and Jackson, 2011; Barbosa et al., 2014). The reasons to automate the manufacturing processes include increased quality and efficiency demands, as well as the presence of hazardous working conditions and the high cost of specialized manual workers. Using technology to automate difficult or repetitive tasks positively impacts safety and ergonomic issues, as well as other labour challenges experienced by many organizations, e.g. aging workforce and the related expected increase of injuries in the labour force (Kozak, 2015). Automated machines are part of the assembly process in different industries. Although automation has been widely adopted in manufacturing, numerous companies still rely on manual workers to perform assembly operations. The current practice shows that the decision to automate rather than include manual workstations is primarily guided by economic considerations and production requirements. Robot technology is widely used in the manufacturing industry when products are well-defined and properly designed. Specifically, high production volumes allow a reasonable payback time for the considerable investment in automatic machines (Lien and Rasch, 2001).

From a lean perspective, the decision to automate parts of the assembly process is based on specific goals: to increase production volume, decrease the through-put time, decrease the lead-time, reduce the value of WIP and improve the assembly quality (Neumann et al., 2002). The indirect costs of planning, automation changes and maintenance tilt the balance in favour of manual processes (Bley et al., 2004).

Previous studies have supported the need for joint optimization of human factors and technical aspects in production system design, but no mathematical model has supported the integration of ergonomics principles during the design of assembly systems (Ólafsdóttir and



Rafnsson, 1998; Coury et al., 2000; Neumann et al., 2002). Recent research has analysed the impact of workplace design on productivity levels, integrating lean concepts with ergonomics principles (Walder et al., 2007; Vieira et al., 2012; Xu et al., 2012; Yusoff et al., 2013; Al Zuheri et al., 2014). These studies do not include the impact of different assembly alternatives (i.e., manual or automatic workstations) during the assembly process design.

#### 2.2.1.2 Integrate ergonomics and automation in lean processes

Lean manufacturing companies aim to improve their productivity and the efficient use of resources through waste removal and cost reduction. The lean definition for waste includes WIP, defects and non-value added time, such as worker time spent waiting for products and unnecessary movements. Cost reduction strategies are directed toward specific efforts that reduce the resources spent on poor quality products, reducing the WIP value and decreasing the transportation costs. Lean thinking also aims the realization of flexible processes and the reduction of overburden and stress, which generate waste (Corominas et al., 2004; Schafer et al., 2008). Several studies have investigated variations in the quality of working life due to the implementation of lean manufacturing (Schouteten and Benders, 2004; Shoaf et al., 2004; Saurin and Ferreira, 2009; Koukoulaki, 2014). The results have drawn both criticism and eulogistic praise of lean manufacturing strategies. Worker interviews and questionnaires and case study analysis of the effects of lean manufacturing on worker safety and health have reported increased health, job satisfaction and job motivation. Consequently, workers perceive better working conditions and avoid excessive fatigue and accidental injuries (Smith, 2003; Vieira et al., 2012; Aqlan et al., 2014).

A parallel research path has demonstrated the disadvantages of lean production and the negative effects on employee autonomy, work demands and psychological strain (Jackson and Martin, 1996; Bao et al., 1997; Ólafsdóttir and Rafnsson, 1998; Leroyer et al., 2006; Lloyd and James, 2008). In particular, the standardization of work processes in lean production methods may hinder empowerment and job control (Klein, 1991; Sprigg and Jackson, 2006). However, numerous studies have attributed the increased work pace and lack of recovery time in lean companies to JIT practices and work standardization (Saurin and Ferreira, 2009). In particular, the rigid application of lean production methods is associated with increased musculoskeletal risk factors and stress in manual workers (Berggren et al., 1991; Brenner et al., 2004; Lloyd and James, 2008; Koukoulaki, 2014). The cause of such a phenomenon is that lean processes frequently result in highly repetitive operations, stressful postures and high forces, while eliminating critical rest periods for employees (Kester, 2013). Work-related MSDs are common occupational diseases among assembly workers due to repetitive motions or heavy workloads (Xu et al., 2012). Injured workers are not able to work, and replacement workers are not as efficient at performing the tasks. Therefore, increased injury rates hinder the desired results for lean processes. In the long term, the economic savings from quality, productivity and efficiency improvements pay for the higher cost of workers' compensation claims for MSDs.

Human factors and ergonomics are key components of the lean strategy, in addition to the lean principles of waste reduction and value creation. Thus, successful lean processes integrate ergonomics in the early stages of the assembly process design.

The integration of technology to automate difficult or repetitive tasks positively impacts safety and ergonomic issues. However, several companies have reported high levels of dissatisfaction with automation investments in the past, due to the inflexibility of these facilities in terms of reflecting changing market conditions (Bley et al., 2004). The shorter product life cycle and high product complexity further explain the trend of assembly automation reduction. Automation in lean production systems requires high flexibility and the ability to increase the throughput, despite dynamic changes, such as demand or supply disruptions, with no additional resources (Moghaddam and Nof, 2015). When flexibility is necessary and companies are required to decrease the lot size, good solutions are missing (Krüger et al., 2009). Further limitations of the current automated systems include the high programming efforts and limited ability to assemble not standardized products. Krüger et al. (2009) have investigated the requirements for a successful cooperation of human and machines in assembly lines. Their research suggests a sequential division of tasks among workers and machines to obtain the best capabilities of robotic and human capabilities. Conventionally, machines perform simple tasks upstream in the assembly line. The complex and frequently varied tasks that give the assembled products their individual features are performed downstream by human operators.

The following Section 2.2.1.3 introduces the innovative mathematical model for the design of ergonomic lean processes in hybrid assembly lines. Given the production requirements, the product characteristics and the assembly tasks, the model defines the optimal assembly sequences for manual and automatic workstations. Two objective functions drive the optimization model and define optimal assembly processes for each product family. The first objective addresses the lean principles of JIT production and WIP reduction. The second objective aims to reduce the overall cost of the hybrid assembly system. The aim is to improve ergonomics for manual workers and cost reduction for the whole assembly process, following the principles of lean manufacturing.

### 2.2.1.3 Assembly process modelling

Hybrid assembly lines involve close cooperation between humans and automated machinery. The effective cooperation is possible when the production requirements meet the ergonomics principle for worker health and safety. The proposed ergonomic lean approach is based on the human-paced work principle. Automated machines process enough products to keep up with the pace of the successive manual workstations. Thus, the final stages of the assembly process pull the production flow, reflecting a JIT perspective. The result is a lean assembly process, in which manual workers set the machine assembly pace.

Buffer inventory is necessary to ensure that parts are available for downstream workstations. These buffers prevent the delay of upstream machines and the consequent reduction of throughput. Furthermore, additional buffers preceding late workstations collect processed semi-products waiting for the late process (Figure 2.16). In particular, an additional buffer is necessary at manual workstations to prevent semi-product shortages due to the delay of manual workers.

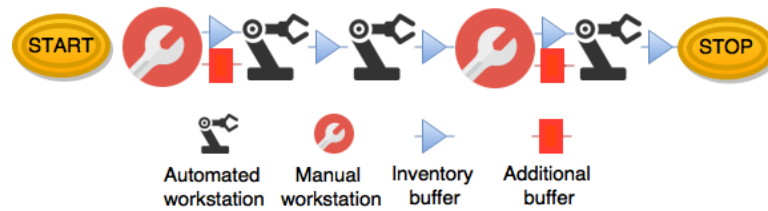

Figure 2.16 Example of hybrid assembly line

Figure 2.16 shows inventory buffer and additional buffer for a hybrid assembly line. The blue triangle indicates the presence of inventory buffer, while the red rectangle reflects the additional buffer. Because manual workstations pull automated workstations in the proposed lean assembly process, no additional buffer is required between an automated machine and the following workstation, whether it is manual or automated. However, an additional buffer is required after each manual workstation. The presence of the buffer increases the amount of inventory and WIP. High inventory levels lead to higher inventory storage costs, as well as longer throughput times for products to move through the system. Consequently, lean principles aim to reduce WIP and the amount of components and assemblies. Figure 2.17 shows the sequential processing alternatives between manual and automated workstations.

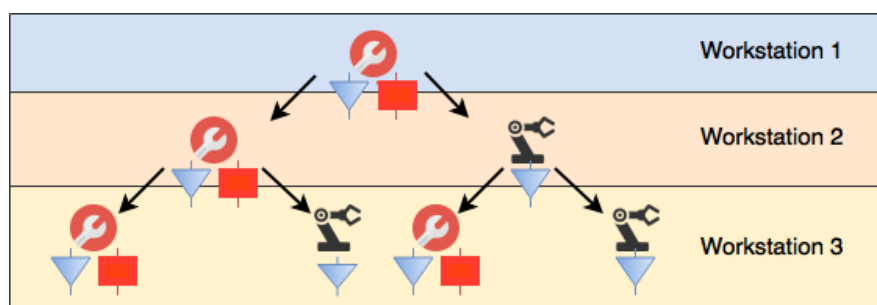

Figure 2.17 Sequential processing alternatives in hybrid assembly lines.

The additional buffer is required after each manual workstation and before the automated machines followed by a manual workstation (Figure 2.17). The buffer size depends on the desired safety time,  $f$ , to prevent the production interruption in case of semi-finished product shortage, and the mean lateness,  $e$ , of the manual workstations. Equation (1) defines the

buffer inventory size to protect throughput from any interruptions, while Equation (2) defines the additional buffer size.

$$j_{p,t} = \frac{f}{d_{p,t}} \quad (1).$$

$$s_{p,t} = \frac{e}{d_{p,t}} \quad (2).$$

Given the cycle time ( $d_{p,t}$ ) to perform manual task  $t$  for product  $p$ ,  $j_{p,t}$  is the number of  $p$  products in the buffer inventory to ensure that parts are available for the downstream workstations (Equation 1). Similarly,  $s_{p,t}$  is the number of  $p$  processed products in the additional buffer waiting for the late manual process.

Automation requires high investment costs in machinery and skilled labour. Companies have reported that the planning and operation expenses exceed the cost reductions promised by high automation in production. Furthermore, indirect costs, such as defects cost, planning and retrieving the know-how for automated machinery reprogramming, reduce the satisfaction with investments in automation (Bley et al., 2004). Automation is an interesting option when labour costs and deduction costs for facilities are significant. Equation (3) introduces the total cost of the hybrid assembly process due to automated machinery,  $C_{machinery}$  (Equation 4), and the cost of the hybrid assembly process due to manual labour,  $C_{labour}$  (Equation 5).

$$C_{total} = C_{machinery} + C_{labour} \quad (3).$$

$$C_{machinery} = \sum_T (x_t \cdot i_{max\ t}) + \sum_T \sum_P (r_t \cdot i_{p,t}) + \sum_T [q_t \cdot (\sum_P g_p \cdot c_{p,t})] + \sum_T [o_t \cdot (\sum_P g_p \cdot v_{p,t})] \quad (4).$$

$$C_{labour} = \sum_T y_t \cdot l_{p,t} + \sum_T n_t \cdot l_{max\ t} + \sum_T [o'_t \cdot (\sum_P g_p \cdot v_{p,t})] \quad (5).$$

$C_{machinery}$  is the sum of four different costs: the investment cost for the machinery purchase, the reprogramming cost for the batch switch, the cost of the energy and the non-quality cost for automated production defects. Specifically,  $x_t$  is the investment cost of the automated machinery to perform task  $t$ ;  $r_t$  is the machinery reprogramming cost for the product batch switch;  $q_t$  is the energy consumption of the automatic machine for  $t$ ;  $g_p$  is the daily product  $p$  batch size;  $c_{p,t}$  is the automatic workstation cycle time for product  $p$  for task  $t$ ;  $o_t$  is the defective product percentage of the automatic machine for task  $t$ , and  $v_{pt}$  is the value of product  $p$  after task  $t$ . Equation (6) shows the formulation of  $i_{p,t}$ .

$$i_{p,t} = \left\lceil \frac{k_p}{c_{p,t}} \right\rceil \quad (6).$$

Given  $k_p$  as the takt time of product  $p$ ,  $i_{p,t}$  is the number of required automatic machines working simultaneously for task  $t$  to ensure the production of product  $p$  (Equation 6). Finally,  $i_{max\ t}$  is the maximum number of automatic machines working simultaneously to perform task  $t$ .

Similarly,  $C_{labour}$  is the sum of two different costs: the cost of manual work and the non-quality cost of manual production defect. In addition,  $y_t$  is the manual worker hourly cost to perform task  $t$ , and it includes the cost of worker safety, such as the protections, training and PPE related to task  $t$ .  $o'_t$  is the defective products percentage due to the manual production of task  $t$ . Equation (7) shows the formulation for  $l_{p,t}$ .

$$l_{p,t} = \left\lceil \frac{k_p}{a_{p,t}} \right\rceil \quad (7).$$

Similarly,  $l_{p,t}$  is the number of manual workers required for task  $t$  to ensure the production of product  $p$  (Equation 7). Finally,  $l_{max\ t}$  is the maximum number of manual workers working simultaneously to perform task  $t$ .

The sum of  $C_{machinery}$  and  $C_{labour}$  is the total cost of the hybrid assembly process (Equation 3).

#### 2.2.1.3.1 Operation assumptions

The mathematical model for the design of assembly sequences of manual and automated workstations in hybrid multi-modal assembly lines is subject to the following assumptions:

- Each task  $t$  is performed either by automated machinery or by manual workers for each product type  $p$ . Workers do not operate at automatic workstations and vice versa;
- Each task  $t$  is univocally performed in a single workstation;
- Processing times are deterministic;
- Each product that does not have task  $t$  in his assembly process cycle goes to the next workstation;
- The additional buffer is arranged at each manual workstation, as before the automatic machine following a manual workstation, in order to avoid the machine pacing phenomenon;
- The manual workers monitor the automatic machines in hidden time;
- The automatic machine for task  $t$  is able to process each product type  $p$ ;
- Each task  $t$  is performed in the cycle of at least one product type  $p$ ;
- The same manual workers are employed to produce the whole product  $p$  family;
- The identification of defective products is performed after the assembly process.

Such conditions define the operation assumptions used within the following mathematical model.

#### 2.2.1.3.2 The mathematical model

The Integer Linear Programming (ILP) model seeks the optimal assembly sequences of manual and automatic workstations for hybrid multi-modal assembly lines. Given the characteristics of the assembly process and the automated machines working parameters,

the model assigns manual workers or automated machinery to each workstation. Each assembly sequence includes the ergonomic risk assessment using the OCRA method (ISO 11228-3, 2007) to meet the requirements of the Italian occupational health and safety law for manual material handling of low loads at high frequency (Ministero del Lavoro e delle Politiche Sociali, 2008).

The model inputs address the characteristics of the products, manual processes, automated machines, as well as the production requirements. Table 2.6 provides the notations for the model formulation.

Table 2.6 Indices and parameters for the ILP model.

Indices	
$p$	Product index, $p = 1 \dots P$
$t$	Task index, $t = 1 \dots T$
Parameters	
$a_{p,t}$	1 if task $t$ is standardizable for all the products and the assembly activities are not complex, 0 otherwise [binary]
$b$	Duration of the shift [h]
$c_{p,t}$	Cycle time to perform task $t$ for product $p$ with automated machinery [s/unit]
$d_{p,t}$	Cycle time to perform task $t$ for product $p$ at the manual workstation [s/unit]
$e_{p,t}$	Mean lateness of the manual workstation for task $t$ and product $p$ [s]
$f_{p,t}$	Safety time for task $t$ and product $p$ [s]
$g_p$	Daily batch size of product $p$ [units]
$h_{p,t}$	1 if task $t$ is in the assembly process of product $p$ , 0 otherwise [binary]
$i_{p,t}$	Number of automatic machines required for task $t$ to ensure the production of product $p$ [machines]
$i_{max,t}$	Maximum number of automatic machines working simultaneously to perform task $t$ [machines]
$l_{p,t}$	Number of manual workers required for task $t$ to ensure the production of product $p$ [workers]
$l_{max,t}$	Maximum number of manual workers working simultaneously to perform task $t$ [workers]
$k_p$	Takt time for the production of product $p$ [s/unit]
$o_t$	Percentage of defective products due to automated task $t$ [%]
$o'_t$	Percentage of defective products due to manual task $t$ [%]
$q_t$	Hourly energy consumption of the automated machinery for task $t$ [€/h]
$r_t$	Hourly cost of machine reprogramming for task $t$ [€/machine and hour]
$v_{p,t}$	Value of product $p$ after task $t$ [€/unit]
$x_t$	Hourly cost of automated machinery for the automated task $t$ , safety barriers and transport system of assembled products to the next workstation [€/hour and machine]
$y_t$	Hourly cost of the manual workers at the manual workstation for task $t$ [€/hour and worker]

The parameters for the ILP model in Table 2.6 stem from analysis of the production requirements and the characteristics of the manual workers and automated machinery. Table 2.7 shows the OCRA parameters included in the model of the ergonomic risk assessment (ISO 11228-3, 2007).

Table 2.7 OCRA parameters for the ILP model, referred to the most stressed upper limb (ISO 11228-3, 2007)

OCRA Parameters	
$n_{TC,t}$	Number of technical actions of the task $t$
$k_f$	Constant of frequency of technical actions per minute
$F_{M,t}$	Force multiplier for task $t$
$P_{M,t}$	Posture multiplier for task $t$
$Re_{M,t}$	Repetitiveness period multiplier for task $t$
$A_{M,t}$	Additional multiplier for task $t$
$RC_{M,t}$	Recovery period multiplier
$t_{M,t}$	Duration multiplier

The ILP model decisional variables,  $W_{p,t}$  and  $Z_t$ , define the assignment of either manual workers or automated machines to each workstation.  $W_{p,t}$  defines the presence of automated machinery or manual workers for each workstation (Equation 8).  $Z_t$  is derived from  $W_{p,t}$ , and it defines each task if automated machinery is employed for the assembly process of at least one product type (Equation 9). Analytically,

$$W_{p,t} = \begin{cases} 1, & \text{if task } t \text{ in the assembly process of product } p \text{ is performed by automated machinery} \\ 0, & \text{otherwise} \end{cases} \quad \forall p, t \quad (8),$$

and

$$Z_t = \begin{cases} 1, & \text{if automated machinery for task } t \text{ is in the assembly process of at least one product type} \\ 0, & \text{otherwise} \end{cases} \quad \forall p, t \quad (9)$$

The model objective functions are as follows (see Equations 9 and 10).

$$\varphi = \sum_{t=1}^T \sum_{p=1}^P \left\{ \frac{v_{p,t}}{a_{p,t}} \cdot [f_{p,t} \cdot h_{p,t} + e_{p,t} \cdot (h_{p,t} - W_{p,t})] \right\} \quad (10), \text{ and}$$

$$\chi = b \cdot \sum_{t=1}^T (Z_t \cdot x_t \cdot i_{max,t}) + \sum_{t=1}^T \sum_{p=1}^P \frac{1}{3600} (W_{p,t} \cdot q_t \cdot c_{p,t} \cdot g_p) + b \cdot \sum_{t=1}^T [r_t \cdot \sum_{p=1}^P (W_{p,t} \cdot i_{p,t})] + \sum_{t=1}^T [o_t \cdot \sum_{p=1}^P (W_{p,t} \cdot v_{p,t} \cdot g_p)] + b \cdot \sum_{t=1}^T \{y_t \cdot \sum_{p=1}^P [(h_{p,t} - W_{p,t}) \cdot l_{p,t}]\} + \sum_{t=1}^T \{o'_t \cdot \sum_{p=1}^P [(h_{p,t} - W_{p,t}) \cdot v_{p,t} \cdot g_p]\} \quad (11).$$

The first objective function,  $\varphi$ , is from the previous Equations (1) and (2).  $\varphi$  evaluates the daily value of the WIP. Specifically, Equation (10) shows the sum of the values of the inventory buffer and the additional buffer. The inventory buffer is required for each workstation in the assembly process of product  $p$ , ( $h_{p,t}$  not 0). The additional buffer is required for the manual workstations, when  $(h_{p,t} - W_{p,t})$  is not 0.

The second objective function,  $\chi$ , quantifies the daily cost of the hybrid assembly system. The formulation of  $\chi$  is from the previous Equations (3), (4) and (5). Specifically, parameters  $i_{p,t}$  and  $l_{p,t}$  are from the previous Equations (6) and (7).  $\chi$  includes the fixed costs of automated machinery for task  $t$  (e.g. investment costs, safety barriers and transport system of assembled products between consecutive workstations), variable costs of automated machinery as energy consumption costs for such machinery, the machinery reprogramming cost due to the batch switch, the cost of defects caused by the automated machinery, the labour cost, and the cost of manual assembly defects.

The following equations define the proposed model formulation.

$$\min \{\varphi, \chi\} \quad (12).$$

$$W_{pt} \leq h_{pt} \quad \forall p, t \quad (13).$$

$$W_{pt} \leq a_{pt} \quad \forall p, t \quad (14).$$

$$\sum_{p=1}^P W_{pt} \leq P \cdot Z_t \quad \forall t \quad (15).$$

$$Z_t \leq \sum_{p=1}^P W_{pt} \quad \forall t \quad (16).$$

$$\frac{\sum_{p=1}^P \left[ \frac{nTC}{d_{p,t}} (h_t^p - W_t^p) \cdot b \cdot 3600 \right]}{\sum_{p=1}^P [(h_t^p - W_t^p) \cdot (k_f \cdot F_M \cdot P_M \cdot R_{eM} \cdot A_M \cdot d_{p,t} \cdot g_{p,1} / 60)] \cdot R_{cM,t} \cdot t_{M,t}} \leq 2.2 \quad \forall t \quad (17).$$

$$W_{pt} \text{ binary} \quad \forall p, t \quad (18).$$

$$Z_t \text{ binary} \quad \forall t \quad (19).$$

Equation (12) minimizes the introduced objective functions, while Equation (13) ensures that the automated machinery is not assigned to workstations that do not belong to the assembly process of product p. Equation (14) shows that the automated machinery may be assigned to the assembly workstations for products with standardizable assembly characteristics. Equations (15) and (16) ensure that for each task,  $Z_t$  is not zero if automated machinery is employed for the assembly process of at least one product type. Equation (17) stems from the International Standard ISO 11228-3, and it restricts the OCRA index value to a threshold limit value for each task (ISO 11228-3, 2007). Finally, Equations (18) and (19) provide consistence to the binary variables. The proposed model size is  $2(P \cdot T)$  binary variables and  $3(P \cdot T) + 2T$  constraints.

Section 2.2.1.4 introduces a full application of the proposed model to a case study based on the assembly process of hard shell tool cases. The input data are discussed before presenting and comparing the results and conclusions.

#### 2.2.1.4 Case study

This section applies the proposed mathematical model to a real case study of the design of a hybrid assembly process for the manual assembly line of an Italian hard shell tool cases manufacturer. Six assembly workers manually assemble 4 different product types. Figure 2.18 shows the reference assembly process and the manual workstations.

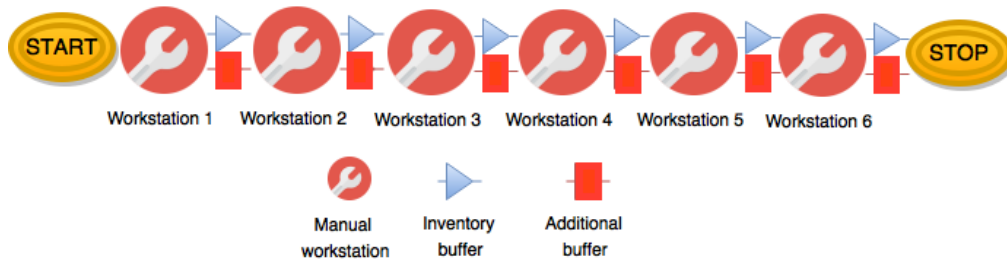

Figure 2.18 Layout of the reference assembly process.



The reference process is a manual assembly line with 6 manual workstations and 6 manual workers. A single worker is assigned to each manual workstation. An inventory buffer and additional buffer are allocated after each manual workstation to prevent delays and disruptions due to component shortages (Figure 2.18). Table 2.8 shows the tasks performed by each worker at each workstation.

Table 2.8 Description of the tasks for the reference assembly line.

Task description	Workstation	Task index $t$	$h_{p,t}$	$a_{p,t}$
Raw material and components retrieval	1	1	1	1
Lock assembly	2	2	1	1
Top sponge application	3	3	1	1
Valve assembly	4	4	1	1
Bottom sponge application	5	5	1	1
Handles assembly	6	6	1	1

The tasks in Table 2.8 describe an assembly process for the production of hard shell tool cases at an Italian manufacturing company. The assembly task sequence is the same for each product type (i.e.,  $h_{p,t} = 1$  for each product type and task). Each task is standardizable and the assembly operations may be performed by automated machinery (i.e.,  $a_{p,t} = 1$  for each product type and task, Table 2.8).

Sensitive values of the manual assembly process parameters are hidden (e.g., the cycle times, takt times and batch sizes) for confidentiality reasons. The safety time  $f_{p,t}$  varies from 1 to 3 hours, while the mean lateness of manual workstations varies from 2 to 12 seconds, depending on the product type and the task. Table 2.9 shows the other model parameters.

Table 2.9 Case study parameters.

$t$	1	2	3	4	5	6
$i$ [machines]	1	1	1	1	1	1
$l_{max,t}$ [workers]	1	1	1	1	1	1
$o_t$ [%]	2	2	1	2	1	2
$o'_t$ [%]	4	5	3	5	3	5
$q_t$ [€/h]	2.80	2.40	1.20	1.20	1.20	2.40
$r_t$ [€/machine and hour]	100	100	100	100	100	100
$x_t$ [€/hour and machine]	56	40.88	32.1	47.44	32.1	40.88
$y_t$ [€/hour and worker]	15	15	15	15	15	15

Table 2.10 OCRA parameters for the ergonomic risk assessment through OCRA method.

OCRA parameters						
$t$	1	2	3	4	5	6
$n_{TC,t}$ Product 1	14	8	5	4	3	12
$n_{TC,t}$ Product 2	15	8	5	5	3	12
$n_{TC,t}$ Product 3	14	8	5	4	3	12
$n_{TC,t}$ Product 4	15	10	5	5	3	12
$k_f$ Product from 1 to 4	30	30	30	30	30	30
$F_{M,t}$ Product from 1 to 4	0.65	0.35	1.00	0.85	1.00	0.20
$P_{M,t}$ Product from 1 to 4	0.60	0.60	1.00	0.60	1.00	0.60
$Re_{M,t}$ Product from 1 to 4	1.00	0.70	1.00	0.70	1.00	0.70

$A_{M,t}$ Product from 1 to 4	1.00	0.90	1.00	0.95	1.00	0.80
$Rc_M$	0.60	0.60	0.60	0.60	0.60	0.60
$t_M$	1.00	1.00	1.00	1.00	1.00	1.00

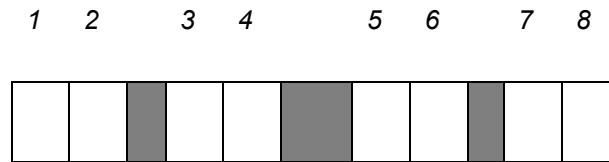

Figure 2.19 Distribution of recovery period

Table 2.10 shows the OCRA parameters for the ergonomic risk assessment using the OCRA method (Occhipinti 1998, ISO 11228-3 2007). The values of the technical actions  $n_{TC,t}$  refer to the most stressed arm for each worker. The work shift is 8 hours, and breaks are distributed as shown in Figure 2.19. A lunch break and two 10-minute breaks are distributed throughout the 8-hour shift. Given the recovery distribution in Figure 2.19,  $Rc_M$  is equal to 0.60 for each worker, corresponding to 4 hours without an adequate recovery period. Job rotations are not allowed during the work shift, and each worker performs the same single task for the entire 8 hours. Therefore, repetitive manual tasks last for a relevant part of the shift, and  $t_M = 1$  for each worker.

The OCRA indices in Table 2.11 define the workers' exposure to repetitive movements of the upper limbs.

Table 2.11 OCRA index values for the ergonomic risk assessment of assembly line workers in the reference assembly line.

Worker	Task	OCRA Index
Worker 1	1	3.4
Worker 2	2	1.3
Worker 3	3	0.7
Worker 4	4	1.5
Worker 5	5	0.6
Worker 6	6	3.7

The OCRA index is computed for each task adopting the multiple-task analysis (ISO 11228-3). Specifically, each task,  $t$ , is considered as the sum of multiple repetitive sub-tasks for the assembly of product,  $p$ , such that  $h_{p,t}=1$ . The threshold limit value of the OCRA index for hand activities is 2.2. Lower values of the OCRA index define activities that pose an acceptable risk. High OCRA indices (greater than or equal to 3.5) characterize high-risk repetitive tasks (Occhipinti, 1998, ISO 11228-3, 2007). Table 6 shows that high risk repetitive movement of the upper limbs is associated with the task performed at workstation 6 (i.e., the OCRA index for the manual worker at workstation 6 is equal to 3.7).

The introduced data define the model inputs for the considered case study. Forty-eight binary variables are introduced and subjected to 60 feasibility constraints. The model and the input data are coded in AMPL language and processed adopting the Gurobi Optimizer© v.5.5 solver. An Intel® Core™ i7-4770 CPU @ 3.50GHz and 32.0GB RAM workstation was used. The average solving time was approximately 0.5 seconds. The key outcomes are discussed in the following section.

Section 2.2.1.5 shows the effects of the introduced bi-objective mathematical model and describes how it can support researchers and practitioners in the design of efficient assembly lines, meeting both the lean principles and ergonomic requirements for safe assembly work.

### 2.2.1.5 Results and discussion

This section introduces the results of the application of the bi-objective mathematical model to the reference case study. The aim is to define optimal bi-objective layout solutions, ensuring the minimization of the WIP and the cost reduction of the hybrid assembly system. Each bi-objective solution identifies an assembly layout alternative that make each objective function “quasi” optimal. The study adopts the bi-objective optimisation approach proposed by Messac et al. (2003). Equation (10) and Equation (11) are the objective functions of the bi-objective optimisation model.

The normalized Pareto frontier in Figure 2.20 shows the trends of the two objective functions in the normalized *WIP-Cost* diagram (Messac et al., 2003). The points from *W* to *C* are the Pareto points composing the normalized Pareto frontier (Figure 2.20). Each Pareto point represents an effective non-dominated trade-off assembly layout configuration.

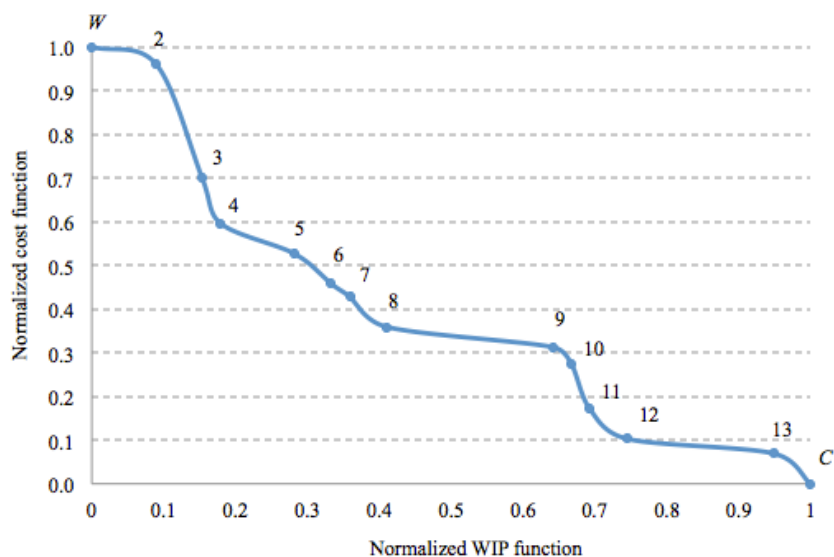

Figure 2.20 Normalized WIP-Cost Pareto frontier.

Table 2.12 Pareto points coordinates.

Pareto Point	$\bar{\varphi}(j)$	$\bar{\chi}(j)$
<i>W</i>	0.00	1.00
2	0.09	0.96
3	0.15	0.70
4	0.18	0.60
5	0.28	0.53
6	0.33	0.46
7	0.36	0.43
8	0.41	0.36
9	0.64	0.31
10	0.67	0.28
11	0.69	0.17
12	0.74	0.10
13	0.95	0.07
<i>C</i>	1.00	0.00

Point *W* (0;1) is the normalized anchor point for the normalized WIP objective function,  $\bar{\varphi}(j)$  (i.e., the assembly layout solution in point *W* ensures the minimum cost of the WIP). Point *C* (1;0) is the normalized anchor point for the normalized cost objective function,  $\bar{\chi}(j)$  (i.e., the assembly layout solution in point *C* ensures the minimum cost of the assembly system). Each Pareto point from  $j=2$  to  $j=13$  identifies a bi-objective solution that make “quasi” optimal each objective function (Figure 2.20 and Table 2.12). The choice among the Pareto points is not univocal. It depends on the importance given to the model drivers,  $\bar{\varphi}(j)$  and  $\bar{\chi}(j)$ . Equation (20) introduces a heuristic criterion to evaluate the decision.

$$D(j) = \bar{\varphi}(j) + \bar{\chi}(j) \quad (20).$$

The decision function  $D(j)$  matches the trends of both the WIP and the cost functions. An effective trade-off configuration is at its minimum value (Figure 2.21 and Table 2.13).

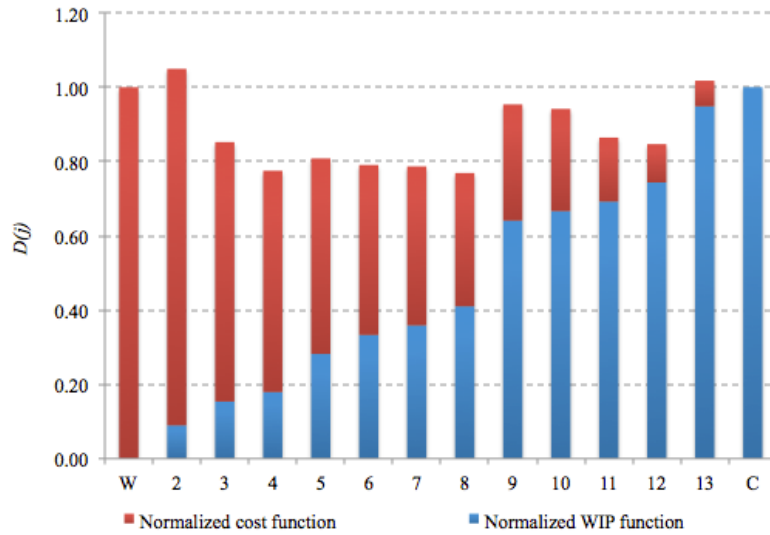

Figure 2.21 Decision function chart for the Pareto points.

Table 2.13 Decision function values for each  $j$  point.

$j$	$W$	2	3	4	5	6	7	8	9	10	11	12	13	$C$
$D(j)$	1.00	1.05	0.85	0.78	0.81	0.79	0.79	0.77	0.95	0.94	0.86	0.85	1.02	1.00

The solution in point  $j=8$  minimises the decision function  $D(j)$ . The assembly layout for such a point is a good trade-off between the two normalized anchor points  $W$  and  $C$  [i.e.,  $\bar{\varphi}(j=8) = 0.41$  and  $\bar{\chi}(j=8) = 0.36$ , Table 2.12]. Given the un-normalized lower bounds for the two objective functions  $\chi$  and  $\varphi$ , the performance losses are  $\Delta\chi(j=8) = 0.06\%$  and  $\Delta\varphi(j=8) = 8.49\%$ . Figure 2.22 shows the assembly layouts for solutions at points  $W$ ,  $C$  and  $j=8$ .

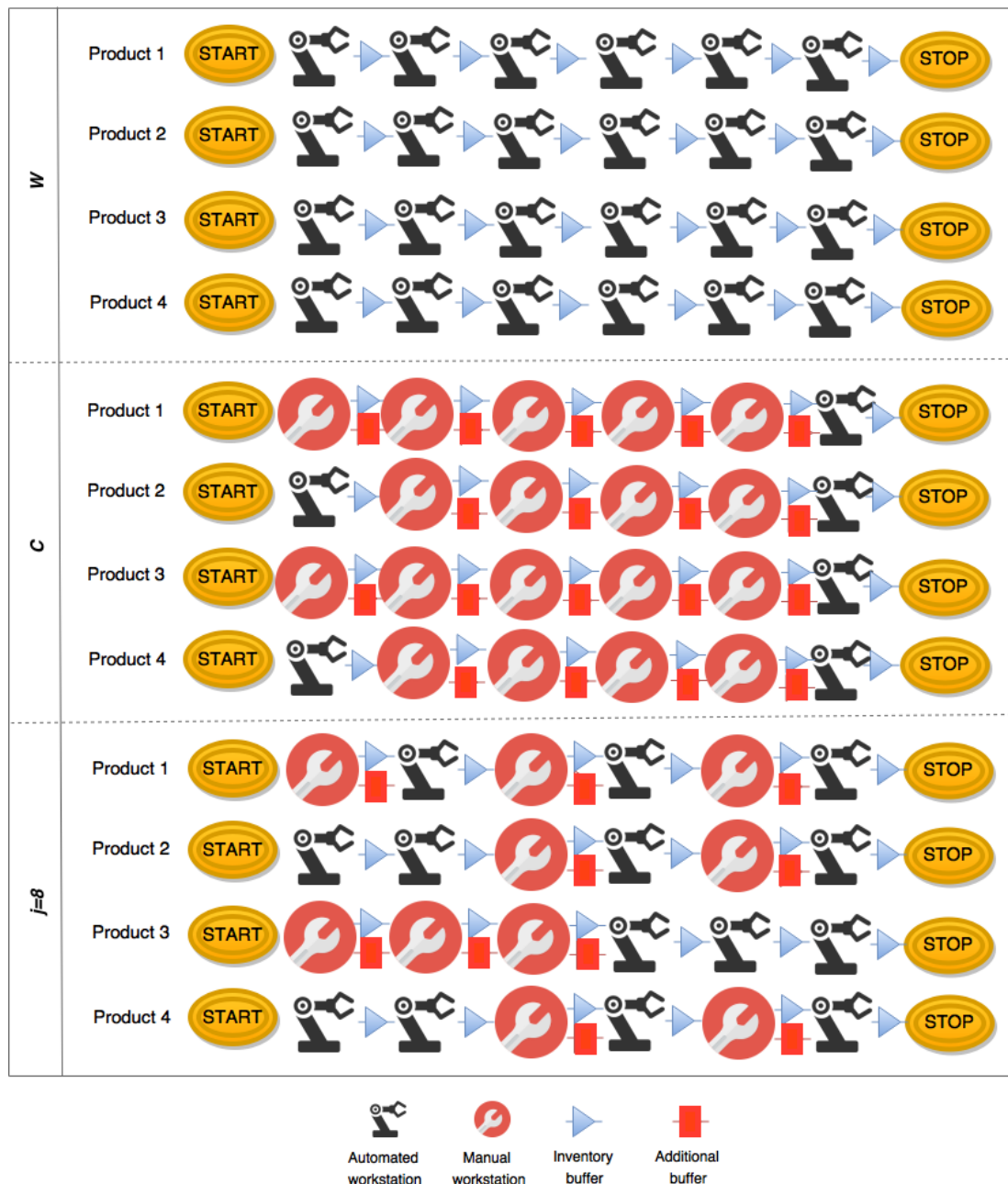

Figure 2.22 Layout of the assembly process for solutions in points  $W$ ,  $C$  and  $j=8$ .

The assembly layout for the solution at point  $W$  minimizes the daily cost of the WIP, while the assembly layout for solution at point  $C$  minimizes the daily cost of the assembly system (Figure 2.22). The assembly layout at point  $j=8$  matches the production requirements of the assembly system, representing a good trade-off between the two introduced objective functions. The three assembly layouts in Figure 2.22 ensure that task  $t=6$  is performed by automated machinery (i.e., the OCRA index for worker 6 in the reference case study is higher than the threshold limit value).

Table 2.14 OCRA index values for the ergonomic risk assessment of assembly line workers in point C and point  $j=8$ .

Worker	Task	OCRA Index in C	OCRA Index in $j=8$
Worker 1	1	2.1	2.1
Worker 2	2	1.3	2.1
Worker 3	3	0.7	0.7
Worker 4	4	1.5	0
Worker 5	5	0.6	0.4
Worker 6	6	0	0

The assembly layouts at point  $j=8$  and point C suggest the adoption of automated machinery for products  $p=2$  and  $p=4$  in task  $t=1$ . Consequently, the exposure to the ergonomic risk of worker 1 reduces and the OCRA index value for task  $t=1$  decreases as well (see Table 2.11 and Table 2.14).

#### 2.2.1.6 Conclusions and considerations on the ergonomic design of assembly lines for lean manufacturing

Lean manufacturing is a production strategy that is used to increase profit by eliminating waste. After the success of the Japanese Toyota Production System in the 1980s, lean manufacturing was rapidly established in the worldwide manufacturing industry. Despite the promising results in the economic performances of some companies, recent studies have shown a potential correlation between specific lean practices and workers' ergonomics, occupational health and related risk factors. However, automation plays a strategic role in increasing productivity and reducing the production time in manufacturing companies. Further reasons to automate the manufacturing processes include the presence of hazardous working conditions and the high cost of specialized manual workers. The current market requires companies to find a balance between the advantages of automated production and the dynamic demand for customized products. When automation cannot provide great flexibility, production system design requires the joint optimization of human and technical aspects.

This Section addresses the design of hybrid assembly lines, fulfilling the principles of lean manufacturing and the ergonomic requirements for safe assembly work. A bi-objective integer linear programming mathematical model drives the choice between manual and automatic workstations. The primary assumption is the design of hybrid lean processes that avoid the machine pacing of workers and the related harmful effects. Given the production requirements and characteristics of the work system, the result is a set of worker-paced hybrid assembly line solutions. The model defines the sequences of manual and automatic workstations, in which the machine pace is set by the manual workstations. Furthermore, each assembly line solution ensures an acceptable risk level of repetitive movements, as required by current law. The case study introduces the application of the proposed mathematical model to an assembly line. The aim is to investigate the impact of ergonomics

on the lean manufacturing process. Results show that worker ergonomics is a key parameter of the assembly process design, as other lean manufacturing parameters, e.g. takt time, cycle time and work in progress. The model includes the OCRA risk assessment, as required by the Italian regulations on occupational safety. Specifically, the mathematical model restricts the OCRA index value to a threshold limit value for each task (ISO 11228-3, 2007). The choice of a different ergonomic risk assessment method might produce different results and have a substantial impact on the design of hybrid assembly lines. Future developments of this work include the adoption of a different ergonomic risk assessment method and the analysis of the impact on the solutions of model. Finally, the proposed mathematical model will be tested on complex assembly lines with no sequential workstations.



## 2.2.2 Ergonomics and human resource management: A mathematical model

The administrative control in this section defines optimal job rotation schedules to improve workers satisfaction and safety. The aim is to reduce the risk of MSDs due to manual handling activities of low loads at high frequency, from a bi-objective perspective. The first goal is to design job rotation schedules improving the person-job fit, i.e. assigning the workers to the tasks that better fit their abilities and competencies. The second objective is to increase the task shifting to meet the ergonomic benefits of the job rotation. Furthermore, the ergonomic risk assessment through OCRA method is ensured for each job rotation program.

A case study, based on a bi-objective analysis, is discussed to show the benefits coming from the application of the proposed model and to evaluate the impact of the ergonomic issues on the overall efficiency of the work system. The key results outline the effectiveness of the proposed method revealing that the ergonomic based approach leads to minimal decreasing in the overall efficiency of the work system. Furthermore, the proposed model is applicable to several contexts where workers are asked to perform repetitive tasks with low loads at high frequency.

### 2.2.2.1 Improving ergonomics through job rotation

Job rotation is a job design technique in which employees are moved between two or more different workstations in a planned manner. Such work practice minimizes the duration of repetitive movements and awkward postures, enhancing the rotation between jobs that use different muscle groups. The general principle of job rotation is to alleviate the physical fatigue and stress for a particular set of muscles by rotating employees among other activities that use different muscle groups. Several studies recommend implementing a job rotation strategy for the scheduling of the activities among the workers. Both personnel and companies benefit from the introduction of a scheduling program. As a benefit to the personnel, job rotation reduces the injuries due to performing repetitive tasks as well as fatigue, stress and boredom. Since workers rotate between several workstations, they gain multiple skills to perform different tasks as well as responsibilities. Such skill availability gives the company great flexibility and the ability to deal with change and uncertainties.

Job rotation generates costs and productivity losses due to the effect of worker learning and forgetting. The recent literature shows that the movement to another workstation allows learning a new set of skills. Despite of that, an excessive number of shifts causes previous skills and productivity decrease, and a trade-off between long and short rotation interval is desirable (Azizi, Zolfaghari & Liang 2010). A research by Kuijer et al. (1999) has shown that job rotation leads to an overall reduced physical workload of the employees. Particularly, both perceived, postural and energetic load decrease after the introduction of job rotation. Job rotation leads to significant reduction of monotony, fatigue and cumulative trauma disorders.

Several studies suggest designing job rotation programs to reduce the frequency and the exposure to the ergonomic risk. Carnahan et al. (2000) describe an integer programming optimization model and a genetic algorithm for the design of safe lifting task rotation schedules, considering percentiles of the working personnel. Tharmmaphornphilas et al. (2003) develop worker schedules by means of computer programming model to reduce the daily dose of noise exposure of sawmill workers. Job rotation programs aiming to prevent MSDs encompass all the dimensions of the work system. To enhance the ergonomic benefits of job rotation, the description of the work system must be detailed. Aptel et al. (2008) suggest a four-step process to assess the MSD prevention of job rotation systems: describe the rotation system in detail, ascertain the characteristics of the population concerned, assess its experience of the work, and measure the degree of biomechanical demand of the workstations.

Recent literature shows that work rotation for MSD prevention is relatively ineffective when the rotating tasks are similar (Aptel et al. 2008). Few studies assume that job rotation programs enhance the risk of low back pain due to the exposure to peak forces. The design of job rotation schedules should consider the variability of the movement and the intensity variation of the biomechanical demand (Diego-Mas et al. 2009). Diego-Mas et al. (2009) propose a genetic algorithm which compares task requirements with worker abilities to design effective job rotation programs. Asensio-Cuesta et al. (2012) and Boenzi et al. (2013) present different methods to design job rotation schedules of low loads at high frequency manual tasks. The first proposes a genetic algorithm alternating high and low demand activities to support the recovery of the workers. The latter describes two integer programming model to find both break and job rotation schedules, considering equal-skilled operators. Both the two researches include the ergonomic risk assessment through the OCRA method.

Section 2.2.2.2 introduces the modelling of the person job-fit problem, while the mathematical model formulation follows next.

#### 2.2.2.2 The person-job fit problem

The optimal assignment of the workers to the workstations is accomplished by considering the different competencies and physical characteristics of the working population. Each worker  $w$  is characterized by a set of personal skills and ability competencies, besides each workstation  $s$  requires different abilities to perform the required task. The person-job fit is defined as the compatibility between individuals and the job or tasks that they perform (Schyns 2007). The higher the person-job fit, the higher the task performance is. The aim is to assign the workers to the workstation that better fit their skills and competencies to improve the productivity of the whole system.

In the following, 23 items define each workstation and the requirements to perform the demanded tasks. Such items belong to four categories, similarly to the sets defined by Diego-Mas et al. (2009). Table 2.16 shows the reference items for the considered tasks.

Table 2.15 Items to define the person-job fit

Category	Item
Movements	Arm abduction, Arm extension/flexion, Elbow flexion, Neck extension/flexion, Neck turning, Neck lateralization, Pinching with the fingers, Trunk extension/flexion, Trunk rotation
Physical skills	Standing, Walking, Sitting, Exerting force standing still, Exerting force in movement
Competencies and technical skills	Computing capacity, Using assembling tools, Driving forklift truck, Writing, Using keyboard, Using mouse
Relational skills and mental capacities	Reasoning, Responsibility/taking complex decisions, Initiative/autonomy

The first category encompasses each muscular movement,  $m$ , of the upper limbs and trunk to perform the required task, while category “Physical skills” refers to general capacities,  $p$ , as standing and sitting. The last two sets of items assess the desired technical skills,  $c$ , together with the relational requirements,  $r$ , demanded by the workstation.

The content of each activity is analysed and the scoring system for the workstation assessment is shown in Table 2.16.

Table 2.16. Workstation assessment: scores for the items of each category.

Movements			Physical skills, competencies and technical skills, relational skills	
<i>Frequency of movement / minute</i>	<i>of</i>	<i>Score</i>	<i>Skill requirement to perform the task</i>	<i>Score</i>
Very high - >8		6	Normal	6
High - 3-7		3	Low limitation	3
Low - 1-2		2	High limitation	2
Very low – 0		1	Almost unable	1

Scores range from 1 to 6, increasing when both the frequency of movements and the skill requirements are high. The worker’s ability to perform the tasks on each workstation is analysed, as well. The same categories used for the workstation assessment describe the capacity of the worker to perform the movements, the competences and the personal skills. Table 2.17 describes the scoring system adopted for the worker assessment.

Table 2.17. Worker assessment: scores for the items of each category.

Movements		Physical skills, competencies and technical skills, relational skills	
<i>Frequency of movement / minute</i>	<i>Score</i>	<i>Skill requirement to perform the task</i>	<i>Score</i>
Very high - >8	8	Normal	8
High - 3-7	3	Low limitation	3
Low - 1-2	2	High limitation	2
Very low – 0	1	Almost unable	1

For the worker assessment, scores range from 1 to 8, increasing when both the frequency of movements and the skill requirements are high.

The introduced scoring systems allow the assessment of the compatibility between workers and tasks to perform. Furthermore, the productivity is ensured when the workstation

requirements are not over the worker's capacities. The following Equation (21) introduces the worker efficiency,  $E_s$ , to perform the task required in workstation  $s$ .

$$E_s = \sum_m \frac{\alpha'}{\alpha} \cdot A + \sum_p \frac{\beta'}{\beta} \cdot B + \sum_c \frac{\gamma'}{\gamma} \cdot \Gamma + \sum_r \frac{\delta'}{\delta} \cdot \Delta \quad (21)$$

$E_s$  is the ratio between the worker capacity to the demand level of the workstation, considering each category of items. Particularly,  $\alpha'$ ,  $\beta'$ ,  $\gamma'$ ,  $\delta'$  are the worker scores and  $\alpha$ ,  $\beta$ ,  $\gamma$ ,  $\delta$  are the workstation scores, for each item. A set of category coefficients,  $A$ ,  $B$ ,  $\Gamma$ ,  $\Delta$ , weights the importance of each group of items to the accomplishment of the task.

The following ILP model for the design of ergonomic job rotation schedules includes the worker efficiency assessment. According to the score systems in Table 2.16 and 2.17, the higher the value of  $E_s$ , the more the worker  $w$  fits the requirements of workstation  $s$ . Before presenting the ILP model, the next Section 2.2.2.3 introduces the adopted assumptions.

### 2.2.2.3 The mathematical model

The ILP model for the design of job rotation schedules is subject to the following assumptions:

- each worker is able to perform all the demanded movement, at different ability levels. Furthermore, no additional training is required to perform each task;
- the workstations admit all the workers. No additional time or interruptions are necessary for the set up of the workspaces;
- the rotation between the different workstations causes no interruptions in the working process since workspaces are located in the same area.

Such conditions define the operation assumptions used within the following ILP model.

The ILP model looks for optimal ergonomic job rotation schedules. The model goal is to maximize the worker efficiency levels, ensuring the ergonomic requirements of manual handling of low loads at high frequency. Each schedule solution includes the ergonomic risk assessment through OCRA method to meet the requirements of the Italian occupational health and safety current law (Ministero del Lavoro e delle Politiche Sociali 2008).

The model inputs deal with the characteristics of both workers and workstations. The following Table 2.18 resumes the notations for the model formulation.

Table 2.18 Indices and parameters for the ILP model

Indices	
$w$	Worker index, $w = 1, \dots, W$
$s$	Workstation index, $s = 1, \dots, S$
$t$	Time slot index, $t = 1, \dots, T$
$m$	Repetitive movement index, $m = 1, \dots, M$
$p$	Physical skill index, $p = 1, \dots, P$
$c$	Competence and technical skill index, $c = 1, \dots, C$
$r$	Relational skill index, $r = 1, \dots, R$
$l$	Upper limb index, $l = 1, 2$
Parameters	
$\alpha$	Repetitive movement $m$ score for workstation $s$

$\alpha'$	Worker $w$ capacity score to accomplish movement $m$
$A$	Movement coefficient [%]
$\beta$	Physical skill $p$ score for workstation $s$
$\beta'$	Physical skill $p$ score for worker $w$
$B$	Physical skill coefficient [%]
$\gamma$	Competence and technical skill $c$ score for workstation $s$
$\gamma'$	Competence and technical skill $c$ score for worker $w$
$\Gamma$	Competence and technical skill coefficient [%]
$\delta$	Relational skill and mental capacity $r$ score for workstation $s$
$\delta'$	Relational skill and mental capacity $r$ score for worker $w$
$\Delta$	Relational skill and mental capacity coefficient [%]
$d$	Duration of the rotation [min]
$n$	Minimum number of workers for each workstation $s$

The parameters for the ILP model in Table 2.18 stem from the analysis of both worker and workstations. The following Table 2.19 shows the OCRA parameters for the ergonomic risk assessment (ISO 11228-3 2007).

Table 2.19 OCRA parameters for the ILP model (ISO 11228-3 2007)

OCRA Parameters	
$n_{TC}$	Number of technical actions in a cycle
$t_C$	Cycle time [s]
$k_f$	Constant of frequency of technical actions per minute
$F_M$	Force multiplier
$P_M$	Posture multiplier
$R_{eM}$	Repetitiveness multiplier
$A_M$	Additional multiplier
$R_{cM}$	Recovery period multiplier
$t_M$	Duration multiplier

The work system is characterized by a set of  $w$  workers who rotate between  $s$  workstations, for  $(T - 1)$  times. Each possible position of a worker within the work system, during a defined time slot, is identified by the  $(w, t, s)$  codification.

The ILP model decisional variables define the position of each worker within the work system, during the work shift. Analytically,

$$Z_{s,t}^w = \begin{cases} 1, & \text{if worker } w \text{ is assigned to workstation } s \\ & \text{during time period } t \\ 0, & \text{otherwise} \end{cases} \quad \forall w, t, s \quad (22)$$

The model objective functions are as follows (see Equations 23 and 24).

$$\varphi = \sum_{w=1}^W \sum_{t=1}^T \sum_{s=1}^S Z_{s,t}^w \cdot \left( \sum_{m=1}^M \frac{\alpha'}{\alpha} \cdot A + \sum_{p=1}^P \frac{\beta'}{\beta} \cdot B + \sum_{c=1}^C \frac{\gamma'}{\gamma} \cdot \Gamma + \sum_{r=1}^R \frac{\delta'}{\delta} \cdot \Delta \right) \quad (23)$$

$$\chi = - \sum_{w=1}^W \sum_{t=2}^T \sum_{m=1}^M \left| \sum_{s=1}^S \alpha \cdot Z_{s,t}^w - \sum_{s=1}^S \alpha \cdot Z_{s,t-1}^w \right| \quad (24)$$

The first objective function,  $\varphi$ , is from the previous Equation (21).  $\varphi$  computes the overall efficiency of the work system. Particularly, Equation (23) is the sum of the worker efficiencies during the time shift. Given the score system in Section 2.2.2.2, the higher such a  $\varphi$ , the higher the overall efficiency level is.

The second objective function,  $\chi$ , analyzes the job rotation schedules from an ergonomic perspective. The succession of high and low demand activities supports the recovery of the workers, i.e.  $\chi$  is a measure of the movement turnover of the work system. Such an objective function includes the absolute difference of movement demands between two consecutive time slots, for each worker,  $w$ , and time slot,  $t$ . Specifically,  $\chi$  is the sum of such absolute

differences. The higher the objective function  $\chi$ , the higher the ergonomic benefits for workers are.

In the following the proposed ILP model formulation.

$$\max \{ \varphi, \chi \} \tag{25}$$

$$\sum_{s=1}^S Z_{s,t}^w = 1 \quad \forall w, t \tag{26}$$

$$\sum_{w=1}^W Z_{s,t}^w \geq n \quad \forall s, t \tag{27}$$

$$\frac{\sum_{s=1}^S \left[ \frac{n_{TC} \cdot 60}{t_c} \sum_{t=1}^T (Z_{s,t}^w \cdot d) \right]}{\sum_{s=1}^S \sum_{t=1}^T [Z_{s,t}^w \cdot (k_f \cdot F_M \cdot P_M \cdot R_{eM} \cdot A_M \cdot d)] \cdot R_{cM} \cdot t_M} \leq 2.2 \quad \forall w, l \tag{28}$$

$$Z_{s,t}^w \text{ binary} \quad \forall w, t, s \tag{29}$$

Equation (25) maximizes the introduced objective functions, while Equation (26) limits each worker to be occupied in one workstation at a time slot. Equation (27) ensures the minimum number of workers for each workstation and time slot, while Equation (28) stems from the International Standard ISO 1122-3 and restricts the OCRA index value to a threshold limit value for each worker and limb (ISO 11228-3 2007). Finally, Equation (29) gives consistence to the binary variables. The proposed model size is of  $W \cdot T \cdot S$  binary variables and  $T \cdot (W + S) + W \cdot L$  constraints.

In the next Section 2.2.2.4 a full application of the proposed model is discussed considering the assembly line for an automotive component of an Italian automotive company. The input data are discussed before presenting and comparing the results and conclusions.

#### 2.2.2.4 Case Study

This section applies the proposed ILP model to a realistic case study. The workstations of an assembly line from an automotive company, together with the worker population, define the overall work system. The reference assembly line consists of 5 workstations where 8 workers perform the required tasks. The number of workers required by each workstation ranges from 1 to 3. The work shift is of 8 hours and breaks are distributed as in Figure 2.23.



Figure 2.23 Distribution of recovery periods

A lunch break and two breaks of 10 minutes each are distributed among the 8 hours work shift (Figure 2.23). The job rotations are seven of 1 hour each. Table 2.20 further presents the features of the introduced work system. Such parameters are among the input data of the model.

Table 2.20 Work system features

Notation	<i>w</i>	<i>s</i>	<i>t</i>	<i>m</i>	<i>p</i>	<i>c</i>	<i>r</i>
Value	8	5	8	9	5	6	3

The set of 23 items in Table 2.20 is considered to analyse the work system. The scores  $\alpha, \beta, \gamma, \delta$  and  $\alpha', \beta', \gamma', \delta'$  are defined for each category of item, workstation and worker, according to the scoring system in Section 2.2.2.2. Coefficients  $A, B, \Gamma, \Delta$  weight the importance of each category of items to the task accomplishment, for each workstation. Finally, the values for the OCRA parameters are drawn from the risk assessment procedure in ISO 11228-3 (ISO 11228-3 2007)

The introduced data fully define the ILP model input to tackle the job rotation programs for the considered case study. 320 binary variables are introduced, while Equations (26) to (29) lead to 120 constraints. Both the model and the input data are coded in AMPL language and processed adopting Gurobi Optimizer© v.5.5 solver. An Intel® Core™ i7-3770 CPU @ 3.40GHz and 16.0GB RAM workstation is used. The branch-and-bound algorithm solving time is approximately of 300 seconds.

The following Section 2.2.2.5 shows the effects of the introduced bi-objective ILP model and its solutions to support researchers and practitioners in the choice of the best job rotation program.

#### 2.2.2.5 Results and discussion

The introduced data fully define the input to the bi-objective ILP model to tackle the design of optimal job rotation schedules for the considered case study. Each bi-objective solution is identified by a set of decision variable values that make “quasi” optimal each objective function. Furthermore, each model solution describes a job rotation program.

At first, limiting the model to the sole  $\varphi$  objective function, its optimal value is  $\varphi = 1,005.82$ , while  $\chi = 2282$  is the optimal value adopting the  $\chi$  objective function, only. Such values identify the so-called anchor points (Messac, Ismail Yahaya & Mattson 2003), called *E* and *J* in the following (see in Figure 2.24). Their coordinates are *E* (1,005.82;20.00) and *J* (914.28;2,282.00).

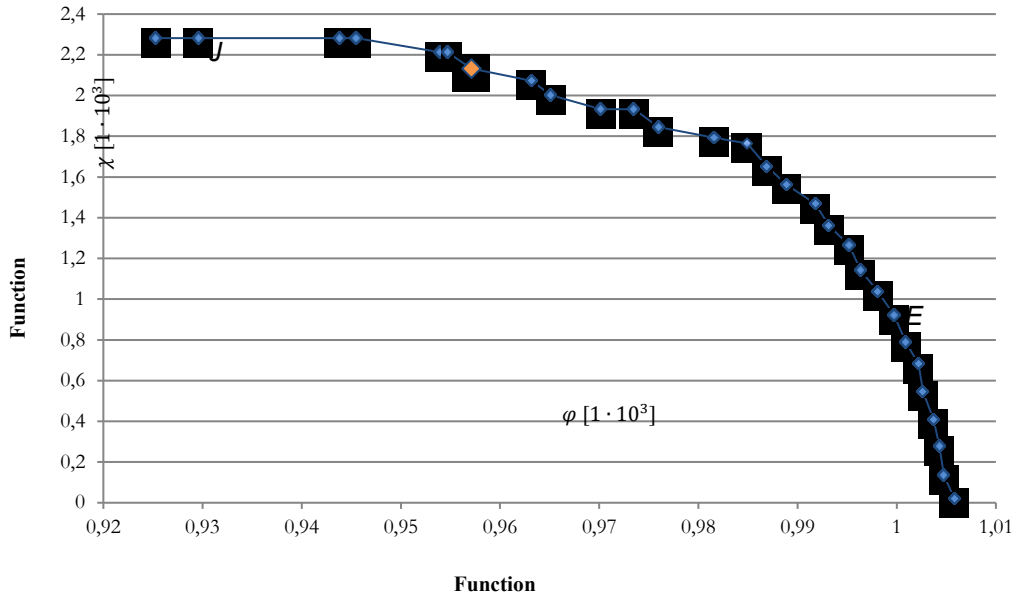

Figure 2.24 Pareto frontier.

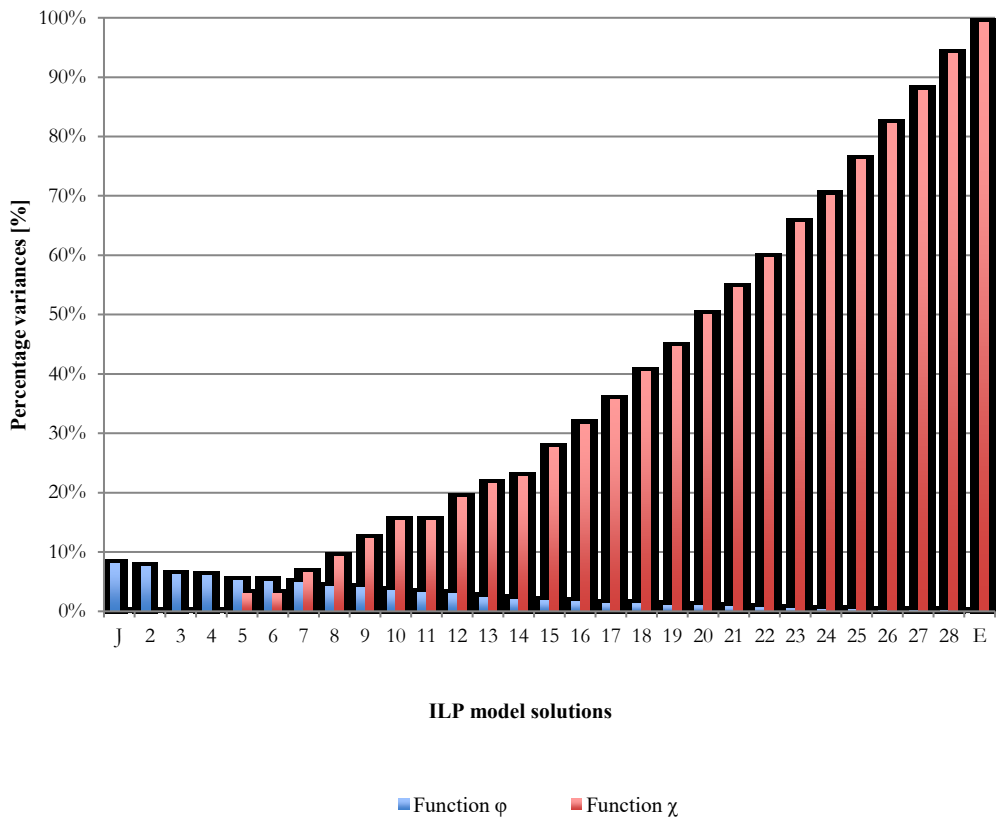

Figure 2.25  $\square$  and  $\square$  variances from the optimal values  $\square$  and  $\square$ .



Table 2.21 OCRA indexes for the most exposed workers to the ergonomic risk.

Worker	Upper limb	$E$	$J$	$\Delta J$	Point 7	$\Delta$ Point 7
1	Left	2.097	1.082	-48%	1.504	-28%
	Right	2.097	1.082	-48%	1.504	-28%
2	Left	1.379	0.756	-45%	0.472	-66%
	Right	1.379	0.756	-45%	0.472	-66%
6	Left	2.128	0.488	-77%	1.723	-19%
	Right	2.128	0.488	-77%	1.723	-19%

Figure 2.24 graphs the obtained Pareto frontier, while the following Figure 2.25 shows the effectiveness of each solution from a bi-objective perspective.

The optimum value for the overall efficiency of the work system is in  $E$ , where the objective function  $\varphi$  is at the peak value (Figure 2.24). The higher the proximity of the solution to the  $\varphi$  optimal value, the lower the movement turnover  $\chi$  is, and vice-versa. The diminution of  $\chi$  from the optimal value in  $J$  is about 99%, i.e. such a solution leads to a dramatic reduction of the ergonomic benefits (Figure 2.25). Furthermore, the ergonomic conditions are improved when the objective function  $\chi$  is at the peak value, i.e. in  $J$ . The reduction of the overall efficiency  $\varphi$  in such a solution is about 8%.

The solutions from points  $J$  to  $E$  define the same number of job rotation schedules that are good alternatives in a bi-objective perspective. Particularly, Point 7 (see the orange point in Figure 2.24) is an effective trade-off between  $E$  and  $J$ . Figure 2.25 shows that both the system efficiency and the movement turnover in such a solution are close to their optimal values.

The ergonomic conditions get worse when  $\chi$  is minimum, i.e. in  $E$ . The job schedule solution in such a point leads to higher values of the OCRA index. Table 2.21 shows the OCRA index values of the most exposed worker of the job schedule in  $E$ , together with the comparison to the solutions in  $J$  and Point 7. The ergonomic risk of Worker 6 is notable, as the OCRA index is close to the threshold limit value.

The ergonomic benefits from the increasing movement turnovers are tangible, as the job schedule solutions in both  $J$  and Point 7 lead to a substantial reduction of the OCRA index values (see  $\Delta J$  and  $\Delta$  Point 7 in Table 2.21).

Each schedule solution is a good job rotation program and ensures both the overall efficiency of the work system and safer ergonomic conditions. Finally, the choice of the best job rotation program is left to the practitioners.

#### 2.2.2.6 Conclusions and considerations on the integration of ergonomics with human resource management

This administrative control focuses on the design of job rotation schedules for workers exposed to the ergonomic risk of repetitive work. Firstly, the workers' competencies and abilities are compared with the activity requirements to prevent MSDs and including workers' disabilities. Such a perspective ensures the optimal person-job fit. Secondly, the job rotation

system guarantees that high and low demand activities are alternated to support the recovery of the workers. These two perspectives lead to a trade-off between long and short rotation intervals. A bi-objective ILP model to optimise the job rotation program is presented. The model aims to maximise the overall efficiency of the workers ensuring the requirements of the work system and safer ergonomic conditions through the movement turnover. Furthermore, it includes the ergonomic risk assessment of each worker.

A case study is presented and the results show that the optimisation of both the overall efficiency and the movement turnover objectives lead to different optimal job rotation programs. Particularly, the key results outline the effectiveness of the proposed method revealing that the ergonomic based approach leads to minimal decreasing in the overall efficiency of the work system. The bi-objective optimisation further introduces several optimal schedule alternatives to help practitioners in the choice of the best job rotation program.

Despite the conclusions drawn from the proposed case study are not general and valid for all contexts, they appear promising suggesting to further investigate this topic to highlight general trends and effective rules-of-thumb to help practitioners to face the design of ergonomic job rotation schedules. Finally, extensions of the model to include the increasing risk for workers rotating from low demand job into high demand job, are among possible extensions of the present study.

## 2.2.3 Proper utilization of tools and equipment

This Section introduces an administrative control method for the reduction of the risk of vibrations in construction industry. The aim is to reduce the risk of concrete drilling addressing workers through the proper utilization of drilling tools and equipment and ensuring a safe exposure to vibrations of hammer drills. Concrete drilling with heavy hammer and rock drills is a physically demanding tasks performed in commercial construction which may be associated with musculoskeletal disorders, such as hand-arm vibration syndrome.

The purpose of the following Section 2.2.3.1 is to investigate the effects of the feed force on handle vibrations and productivity. Holes (diameter=3/4"; depth=3"; N=48) were drilled into concrete blocks with a hammer drill using a laboratory based test bench system under feed force control; feed force ranged from 120 N and 220 N. Handle vibration was collected during drilling with a 3-axis accelerometer and vibration meter. Increasing feed force increased handle vibration levels and productivity up to a force of approximately 170 N beyond which there was little change in vibration levels or productivity. However, the exposure time limit value strongly decreases with the increasing force. A case study shows the productivity and the exposure time variations with different feed force values. Results suggest that the benefit in productivity with high feed force is lower than the benefit in exposure time with low feed force.

However, exposure to forceful exertion and vibration may be reduced depending on bit wear. The purpose of the study in Section 2.2.3.2 is to evaluate the relationship between bit wear patterns and drilling productivity (e.g., penetration rate in mm/s) which was measured using a test bench system for hammer drills. Image analysis methods were used to identify thirteen wear parameters from bit images at various stages of wear. New bits were worn in stepwise process; each step consisted of drilling a prescribed number of holes to a fixed depth into well-aged concrete. Three of the thirteen bit image parameters were strongly related to productivity. The findings may have practical value for end users in identifying bits that should be discarded due to reduced cutting ability.

### 2.2.3.1 The effect of feed force on hammer drill handle vibration and productivity

Drilling holes into concrete is a common task in commercial construction sites. Construction workers typically use heavy hammer and rock drills for placing anchor bolts that support pipes, conduit, ducts or machinery or for setting rebar (e.g., dowel and rod drilling) for structural retrofits, seismic upgrades or extending roads and tarmacs. Concrete drilling is known as one of the most physically demanding tasks in commercial construction (NIOSH 2002). Particularly, overhead drilling into concrete involves standing on a ladder or a scissor lift and holding a heavy hammer drill overhead to drill the holes (Rempel et al. 2010). Commercial construction workers as plumbers, pipefitters, fire sprinkler installers, electricians, carpenters, and sheet metal workers perform such activities for whole work shifts. Drills, jack hammers and conventional pneumatic tools for construction industry are important sources of

hand-arm vibrations (Pelmeur, Leong 2000). Prolonged, extensive exposure to hand-transmitted vibration may cause vibration-induced disorders in the vascular, sensorineural, and musculoskeletal structures of the human hand-arm system, known as hand-arm vibration syndrome (Kim et al. 2007). The development of the hand-arm vibration syndrome is gradual and increases in severity with time, depending on the vibration exposure dose (Su et al. 2014).

Workers using vibrating hand tools are exposed to the risk for developing health problems associated with repeated forceful actions and exposures to hand-transmitted vibration. Hand-arm vibration syndrome and other hand-arm system disorders are associated with such exposures (Welcome et al. 2014).

Previous studies have assessed the work done by vibrating equipment and the transmission of vibrations to the hand-arm system (Dong, Wu & Welcome 2005, Dong et al. 2010, Deshmukh, Patil 2012, Welcome et al. 2015, Xu et al. 2015). McDowell et al. (2007) have studied the relationships between vibration exposure characteristics and their effects on grip and push force-recall performance. Their study showed that the amount of vibration transmitted to the hand-arm system depends on the coupling forces (grip, push, and combined grip and push) at the hand-handle interface. Consequently, the interaction of the hands with the vibrating tool affects the transmission of vibrations from a tool to the hand-arm system. In his study, Deshmukh and Patil (2012) has investigated the relationship between grip strength to human energy expenditure, along with changes in touch sensation.

This study analyses the effect of the applied push force during drilling on hand-arm vibrations and productivity of manual workers. An automated test bench system has been used to evaluate drill handle vibrations under different force conditions of concrete drilling (Rempel, Barr & Antonucci 2015).

The remainder of this study is organized as follows. Section 2.2.3.1.1 introduces the materials and methods adopted during the study. Section 2.2.3.1.2 and Section 2.2.3.1.3 discuss the results and the findings, together with a practical application of the vibration exposure regulations to the introduced force and vibration measurements. Finally, Section 2.2.3.1.4 and Section 2.2.3.1.5 show the conclusions and the future developments of this study.

#### 2.2.3.1.1 Materials and methods

This study consists of fifty-six trials. A hole of 3 inches depth was drilled in a concrete block for each trial. The concrete blocks were produced in June 2015. The characteristics of the concrete are assumed to be the same for each trial. The test bench system developed by Rempel, Barr & Antonucci (2015) performed drilling with an electric hammer drill (TE 70-ATC, Hilti). Six new 3/4" concrete bits were equally employed during the study. During each trial, the average feeding force was controlled by a custom LabView program on a PC. The feed force range during the study was between 120 N and 220 N. The actual feed force value is different for each trial.

A tri-axial accelerometer (Svantek SV106) was attached to the drill handle using hose clamps to measure tool handle vibration acceleration magnitude. The signal was sampled at 2 Hz. A PC software (Svan PC++ v.2.5.18) analyzed the signal and vibration data were stored to a computer. The accelerometer and the test bench system were calibrated prior to use (PCB Piezotronics shaker 394C06).

Productivity was measured as the drilling rate [inches/s], that is the drilling depth over the drilling time to complete the drilling depth. A prior test was performed to define the variation in productivity after ten holes with a new bit. Two new bits were employed to drill eight holes with different values of programmed feed force (120N and 200N). Results show that small variations in productivity are visible after eight holes with a new  $\frac{3}{4}$ " bit (Figure 2.26 and Figure 2.27).

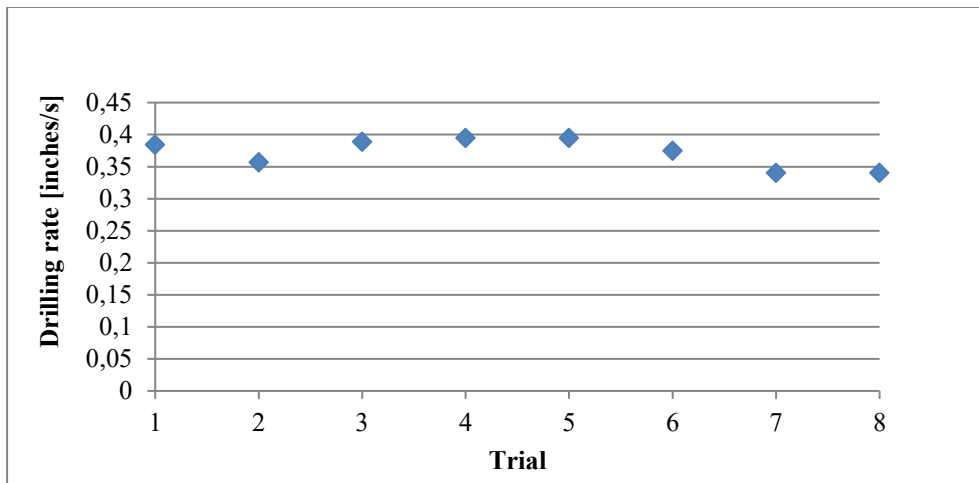

Figure 2.26 Drilling rate variation during drilling eight trials with a new  $\frac{3}{4}$ " bit at 120N feed force.

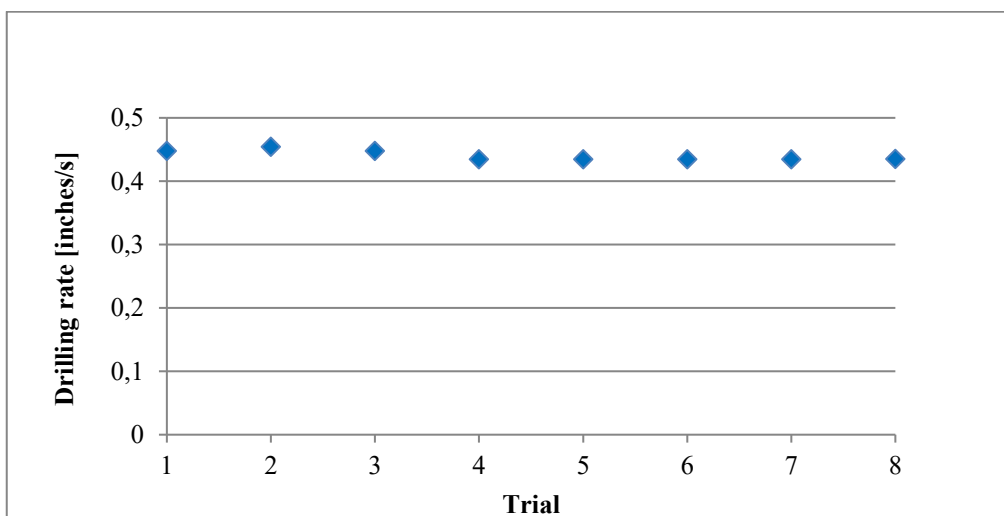

Figure 2.27 Drilling rate variation during drilling eight trials with a new  $\frac{3}{4}$ " bit at 200N feed force.

Figure 2.26 and Figure 2.27 show that the bit wear process has no effect on productivity after eight trials with a new bit. Consequently, the effect of bit wear on productivity is not relevant for the purposes of this study.

### 2.2.3.1.2 Results

The following Figure 2.28 and Figure 2.29 show the tool handle vibration measures for each trial. The acceleration measures are represented with unweighted and weighted (BL-Wh) values, based on the ISO standard 8041:2005. The actual feed force value for each trial is between 94.7N and 211.9N.

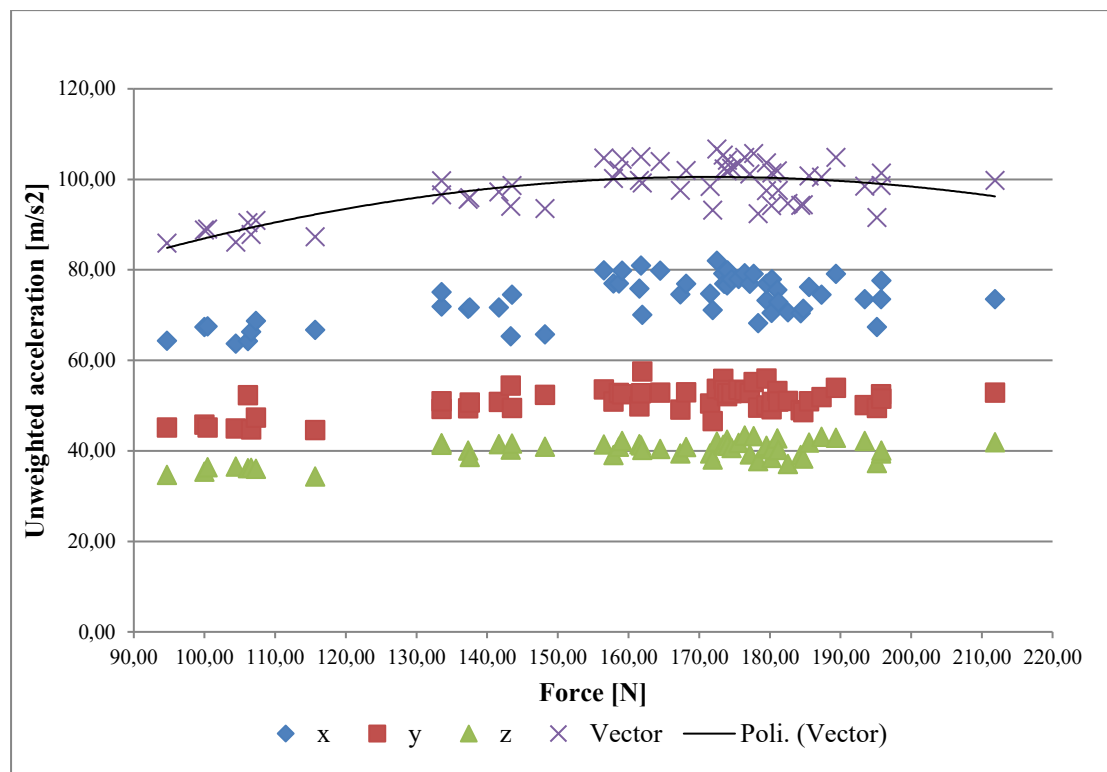

Figure 2.28 Unweighted acceleration measures for each actual feed force value.

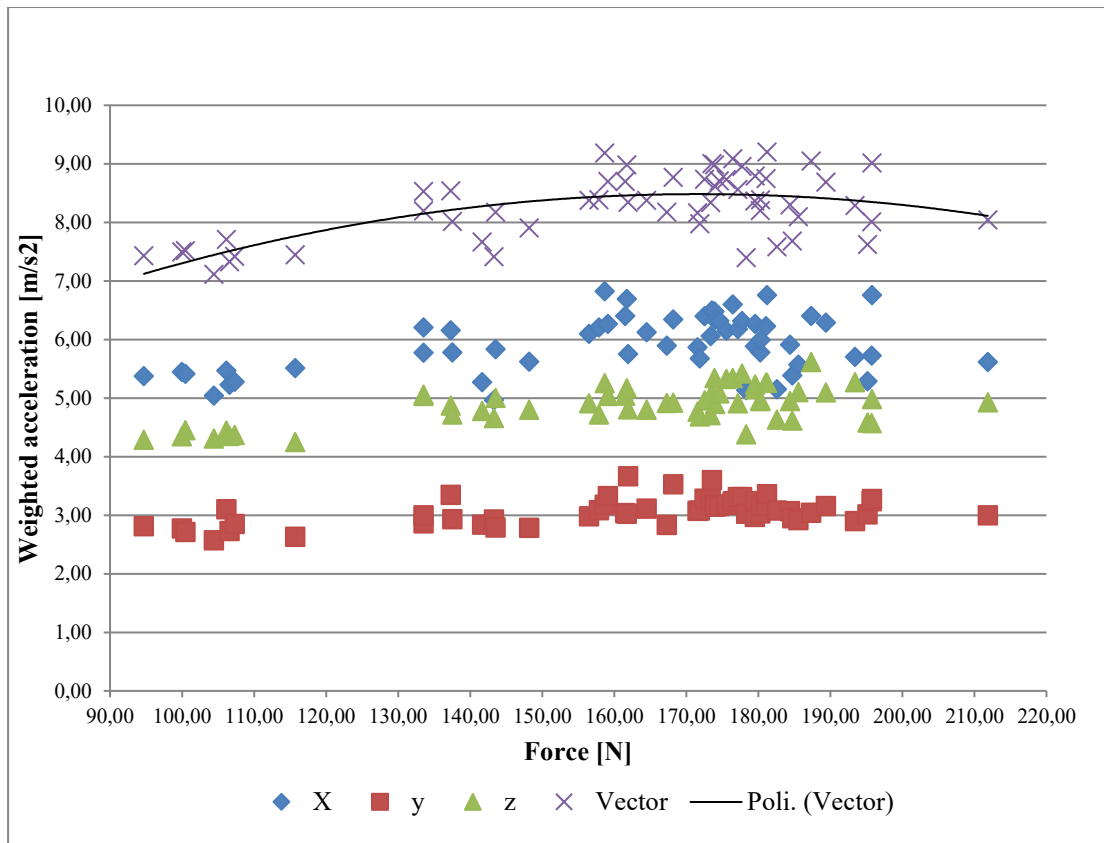

Figure 2.29 Weighted acceleration measures for each actual feed force value.

Figure 2.29 and Figure 2.27 show a moderate positive correlation between force and vibration measure, i.e. the coefficient of determination is  $R^2 = 0.568$  for feed force and unweighted acceleration, and  $R^2 = 0.420$  for feed force and weighted acceleration. These results suggest that the tool vibration acceleration magnitude is slightly related to the feed force applied by the manual worker during drilling into concrete. The higher the applied force, the higher the exposure to vibrations is.

The drilling rate for each trial is in the following Figure 2.30.

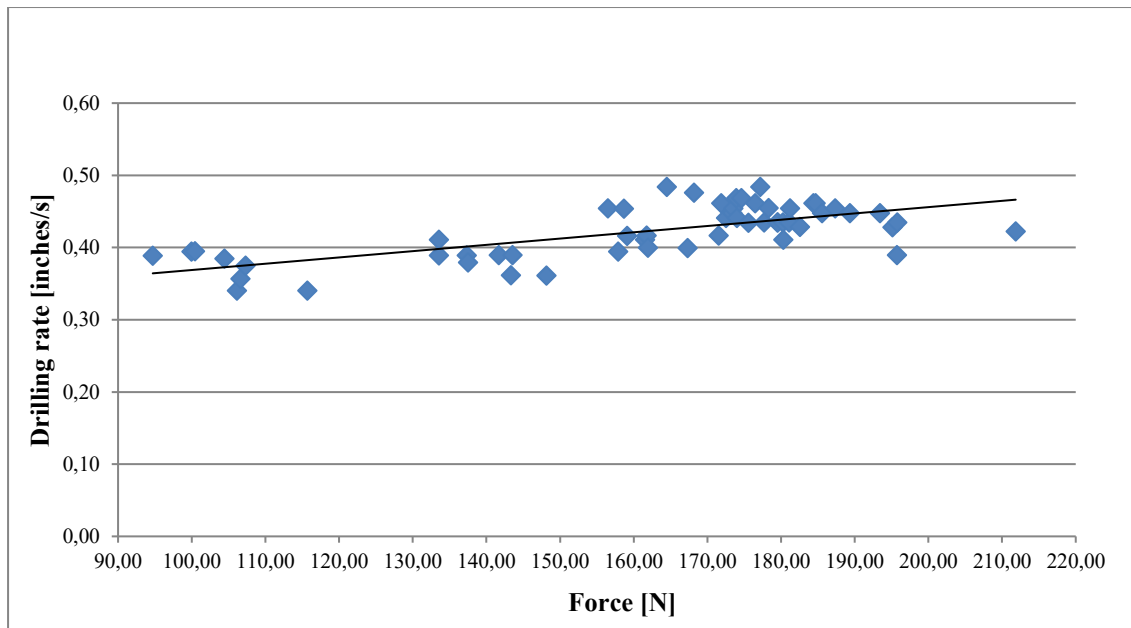

Figure 2.30 Drilling rate for each actual feed force measure.

Figure 2.30 shows a moderate positive correlation between feed force and drilling rate, i.e. the coefficient of determination is  $R^2 = 0.476$ . These results suggest that the productivity is related to the feed force applied by the manual worker during drilling into concrete. The higher the applied force, the higher the productivity of the manual worker is.

For a complete list of the force and vibration measures, see the following Table 2.22.

Table 2.22 Acceleration values for each feed force measurement.

Average Force [N]	Unweighted acceleration x axis [m/s <sup>2</sup> ]	Unweighted acceleration y axis [m/s <sup>2</sup> ]	Unweighted acceleration z axis [m/s <sup>2</sup> ]	Unweighted vector [m/s <sup>2</sup> ]	Weighted acceleration x axis [m/s <sup>2</sup> ]	Weighted acceleration y axis [m/s <sup>2</sup> ]	Weighted acceleration z axis [m/s <sup>2</sup> ]	Weighted vector [m/s <sup>2</sup> ]	Drilling rate [inches/s]
94.71	64.34	45.13	34.67	85.90	5.38	2.81	4.29	7.43	0.39
99.97	67.38	45.76	35.40	88.81	5.45	2.78	4.35	7.50	0.39
100.46	67.53	45.13	36.35	88.99	5.41	2.72	4.45	7.52	0.39
104.43	63.68	44.93	36.56	86.08	5.04	2.57	4.31	7.11	0.38
106.15	64.27	52.30	36.18	90.42	5.47	3.10	4.45	7.71	0.34
106.60	66.30	44.72	36.27	87.81	5.23	2.73	4.36	7.33	0.36
107.30	68.71	47.32	36.06	90.88	5.28	2.85	4.37	7.42	0.37
115.68	66.76	44.62	34.32	87.32	5.51	2.63	4.25	7.45	0.34
133.53	71.86	49.26	41.69	96.58	5.77	2.86	5.06	8.19	0.39
133.54	75.08	50.93	41.35	99.70	6.21	3.00	5.04	8.53	0.41
137.31	71.37	49.43	40.04	95.60	6.16	3.35	4.88	8.54	0.39
137.52	71.70	50.70	38.64	95.94	5.78	2.93	4.72	8.02	0.38
141.66	71.70	50.82	41.50	97.18	5.27	2.84	4.78	7.67	0.39
143.32	65.31	54.39	40.27	94.05	4.97	2.93	4.66	7.41	0.36
143.53	74.47	49.49	41.59	98.62	5.83	2.79	5.01	8.18	0.39
148.16	65.77	52.36	40.93	93.50	5.62	2.79	4.80	7.91	0.36
156.50	79.89	53.58	41.40	104.73	6.10	2.98	4.91	8.38	0.45
157.89	77.00	50.87	39.04	100.21	6.21	3.09	4.72	8.39	0.39



158.66	77.00	52.78	40.88	101.91	6.82	3.18	5.25	9.18	0.45
159.10	79.80	52.48	42.22	104.42	6.27	3.33	5.04	8.70	0.42
161.53	75.86	49.83	41.45	99.78	6.41	3.04	5.04	8.70	0.41
161.75	80.91	52.72	41.21	105.00	6.69	3.03	5.17	8.99	0.42
161.94	70.07	57.54	40.18	99.17	5.75	3.66	4.81	8.35	0.40
164.50	79.80	52.85	40.41	103.89	6.12	3.11	4.80	8.38	0.48
167.31	74.56	49.09	39.45	97.60	5.90	2.83	4.91	8.18	0.40
168.17	76.91	52.97	40.83	101.92	6.35	3.53	4.92	8.77	0.48
171.54	74.73	50.47	39.45	98.43	5.87	3.07	4.77	8.17	0.42
171.89	71.12	46.56	38.11	93.16	5.68	3.08	4.69	7.98	0.46
172.52	82.04	53.70	42.02	106.68	6.40	3.28	4.96	8.74	0.44
173.40	79.16	55.91	41.31	105.35	6.06	3.26	4.71	8.34	0.45
173.54	76.91	53.40	41.21	102.30	6.49	3.60	5.09	9.01	0.45
173.93	76.56	52.06	42.46	101.86	6.48	3.19	5.35	8.99	0.47
174.00	79.89	52.72	41.12	104.18	6.34	3.14	4.90	8.61	0.44
174.60	77.89	52.72	40.64	102.46	6.32	3.16	5.08	8.71	0.47
175.57	77.98	53.52	41.78	103.40	6.15	3.18	5.33	8.73	0.43
176.46	79.25	53.27	43.35	104.87	6.60	3.24	5.35	9.09	0.46
177.17	76.91	52.78	39.22	101.19	6.18	3.31	4.91	8.56	0.48
177.72	79.07	55.21	43.25	105.69	6.32	3.31	5.42	8.95	0.43
178.32	68.23	49.55	37.76	92.39	5.13	3.03	4.38	7.40	0.45
179.53	73.20	50.00	40.60	97.50	5.88	2.97	5.15	8.37	0.43
179.54	76.91	55.98	41.12	103.63	6.27	3.24	5.24	8.79	0.43
180.25	70.47	49.20	38.46	94.16	5.78	3.03	4.96	8.20	0.43
180.30	77.89	50.82	40.37	101.39	5.99	3.17	4.95	8.39	0.41
181.07	75.60	53.21	42.76	101.85	6.23	3.16	5.27	8.75	0.43
181.21	72.86	50.87	40.23	97.55	6.76	3.36	5.26	9.20	0.45
182.57	70.63	50.99	37.11	94.69	5.15	3.08	4.63	7.59	0.43
184.39	70.39	48.98	39.08	94.24	5.91	3.07	4.95	8.30	0.46
184.71	71.37	48.53	38.28	94.41	5.39	2.95	4.62	7.68	0.46
185.54	76.21	50.93	41.83	100.76	5.57	2.91	5.11	8.10	0.45
187.32	74.47	51.88	43.10	100.48	6.40	3.04	5.62	9.05	0.45
189.36	79.07	53.89	42.90	104.86	6.29	3.16	5.10	8.69	0.45
193.42	73.54	50.12	42.17	98.48	5.70	2.90	5.27	8.29	0.45
195.14	67.38	49.49	37.33	91.55	5.29	3.01	4.58	7.62	0.43
195.73	73.54	52.54	39.40	98.59	5.73	3.24	4.57	8.01	0.39
195.78	77.63	51.52	40.04	101.41	6.76	3.28	4.98	9.02	0.43
211.85	73.54	52.85	41.88	99.77	5.62	3.00	4.93	8.05	0.42

The ISO standard defines the daily vibration exposure  $A(8)$  in terms of the 8-h energy-equivalent frequency-weighted vibration total value (ISO 5349-1 2001). Given the total daily duration of exposure to the vibration as  $T_e = 8$  hours, the following Figure 2.29 shows the variation of  $A(8)$  due to the increasing applied feed force.

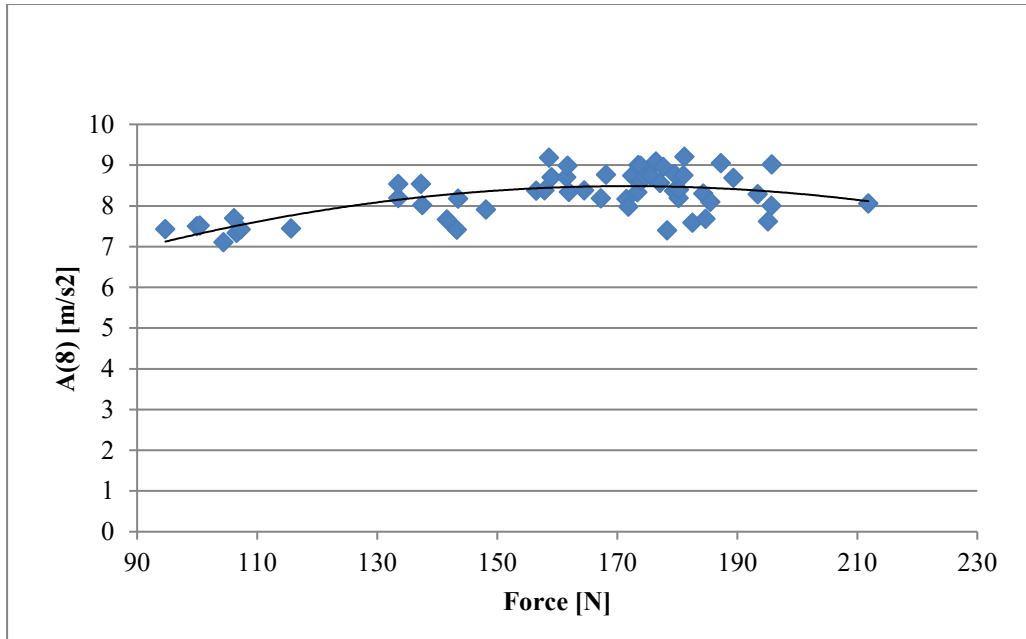

Figure 2.31 Daily vibration exposure for each feed force measure.

These data confirm the moderate positive correlation between force and vibration measure (see in Figure 2.29), i.e. the coefficient of determination is  $R^2 = 0.420$  for feed force and daily exposure. Specifically, increasing the feed force slightly increases the exposure of manual workers to the tool vibrations.

#### 2.2.3.1.3 Case study

The following case study incorporates a practical application of the vibration exposure regulations to the introduced force and vibration measurements. The aim is to investigate the tradeoff between the benefit in productivity with high feed force and the benefit in exposure time with low feed force.

The data in Section 2.2.3.1.2 show that increasing the drilling feed force increases the productivity of manual workers (Figure 2.30), as well as the exposure to hand-arm vibrations (Figure 2.29 and Figure 2.31).

The hand-arm vibration exposure limit value (ELV) is defined as the maximum amount of vibration  $A(8)$  a worker may be exposed to on a eight-hour work-day. The regulations on hand-transmitted vibrations specify the daily ELV, at which employers are required to take action to control risks (Pelmeier, Leong 2000, HSE 2005). Such regulations set out the ELV for hand-arm vibration as  $A(8) = 5 \text{ m/s}^2$ . Given the acceleration measurements,  $a$ , as the weighted vector values in Table 1, the exposure time is from the following Equation (30):

$$T_e = 8h \cdot \left( \frac{5 \text{ m/s}^2}{a} \right)^2 \quad (30)$$

Equation (30) stems from the formulation for the total daily vibration exposure  $A(8)$  of the ISO 5349-1 (2001).

Two reference force measurements  $F_1$  and  $F_2$  are compared to define the tradeoff between the benefit in productivity and the benefit in exposure time. Specifically,  $F_1$  is the feed force value that allows the maximum exposure time to vibrations, while  $F_2$  allows the maximum drilling rate. The following Table 2.23 shows the exposure time and drilling rate values for each force measurement.

Table 2.23 Feed force, exposure time and drilling rate for each reference force measurement.

	$F_1$	$F_2$	Ratio
Feed force [N]	104.43	177.17	-
$\alpha$ [m/s <sup>2</sup> ]	7.11	8.56	-
Exposure time [h]	3.95	2.73	0.79
Drilling rate [inches/s]	0.38	0.48	0.69

The ratio of the exposure time values in Table 2.23 is equal to 0.79. Such ratio is the exposure time value for  $F_2$  over the exposure time value for  $F_1$ . Similarly, the ratio of the drilling rate values in Table 2.23 is equal to 0.69. Such ratio is the drilling rate value for  $F_1$  over the drilling rate value for  $F_2$ . The ratio values in Table 2.23 show that the benefit in productivity with high feed force is lower than the benefit in exposure time with low feed force.

Equation (31) introduces a heuristic criterion to define the optimal feed force value for the data from this study. The aim is to select a feed force value that maximizes the drilling rate and the exposure time, given the productivity and acceleration values in Table 2.22.

$$D(j) = e(j) \cdot r(j) \quad (31)$$

Given the feed force value,  $j$ , the decision function  $D(j)$  matches the trends of both the exposure time,  $e(j)$ , and the drilling rate,  $r(j)$ . An effective trade-off configuration is at its maximum value (Table 2.24).

Table 2.24 Decision function values for each  $j$  point.

$j$	94.71	99.97	100.46	104.43	106.15	106.60	107.30	115.68	133.53	133.54	137.31	137.52	141.66	143.32
$e(j)$	0.92	0.90	0.90	1.00	0.85	0.94	0.92	0.91	0.75	0.69	0.69	0.79	0.86	0.92
$r(j)$	0.80	0.82	0.82	0.79	0.70	0.74	0.77	0.70	0.80	0.85	0.80	0.78	0.81	0.75
$D(j)$	0.74	0.73	0.73	0.79	0.60	0.69	0.71	0.64	0.61	0.59	0.56	0.62	0.69	0.69
$j$	143.53	148.16	156.50	157.89	158.66	159.10	161.53	161.75	161.94	164.50	167.31	168.17	171.54	171.89
$e(j)$	0.76	0.81	0.72	0.72	0.60	0.67	0.67	0.63	0.73	0.72	0.76	0.66	0.76	0.79
$r(j)$	0.81	0.75	0.94	0.82	0.94	0.86	0.85	0.86	0.83	1.00	0.83	0.98	0.86	0.95
$D(j)$	0.61	0.60	0.68	0.59	0.56	0.58	0.57	0.54	0.60	0.72	0.62	0.65	0.65	0.76
$j$	172.52	173.40	173.54	173.93	174.00	174.60	175.57	176.46	177.17	177.72	178.32	179.53	179.54	180.25
$e(j)$	0.66	0.73	0.62	0.63	0.68	0.67	0.66	0.61	0.69	0.63	0.92	0.72	0.65	0.75
$r(j)$	0.91	0.92	0.94	0.97	0.91	0.97	0.90	0.95	1.00	0.90	0.94	0.90	0.90	0.90
$D(j)$	0.60	0.67	0.59	0.61	0.62	0.65	0.60	0.58	0.69	0.57	0.87	0.65	0.59	0.67
$j$	180.30	181.07	181.21	182.57	184.39	184.71	185.54	187.32	189.36	193.42	195.14	195.73	195.78	211.85
$e(j)$	0.72	0.66	0.60	0.88	0.73	0.86	0.77	0.62	0.67	0.74	0.87	0.79	0.62	0.78

$r(j)$	0.85	0.90	0.94	0.89	0.95	0.95	0.93	0.94	0.93	0.93	0.89	0.80	0.90	0.87
$D(j)$	0.61	0.59	0.56	0.78	0.70	0.82	0.71	0.58	0.62	0.68	0.77	0.63	0.56	0.68

The solution in point  $j = 178.32$  N maximizes the decision function  $D(j)$  (Table 2.24). Such feed force value is a good trade-off between the force measurement that allows the maximum exposure time ( $j = 104.43$  N) and the force measurement that allows the maximum drilling rate ( $j = 177.17$  N).

#### 2.2.3.1.4 Discussion

Results in Section 2.2.3.1.4 show that increasing feed force increases handle vibration levels and productivity up to a force level beyond which there is little change in vibration levels or productivity. In particular, data suggest that the tool vibration acceleration magnitude is related to the feed force applied by the manual worker during drilling into concrete. The higher the applied force, the higher the exposure to vibrations is. Furthermore, the case study has shown the productivity and the exposure time variations with different feed force values.

This research confirms the findings from Flegner et al.'s study (2016) on rocks drilling with diamond bits. In particular, the optimal setting of the operating mode of technological parameters, as the feed force, is a fundamental prerequisite for achieving the maximum productivity of the drilling process. Increasing feed force increased the productivity of the drilling process. However, improper choice of long term working mode with high feed force might cause permanent damage to the drill bit, whether drilling is into rock or concrete, and reduce the productivity of the process.

Handle vibration levels increased with the increasing feed force, as well. Consequently, the exposure time limit value strongly decreases with the increasing force, i.e. the drill consumes maximum human energy and the appearance of hand arm vibration syndrome is common in occupations like rock drilling and concrete breaking (Deshmukh, Patil 2012).

The analysis of the vibrations during drilling into concrete has confirmed the results of the study by Shunmugesh and Panneerselvam (2016) on drilling into Carbon Fiber Reinforced Polymer composites. Their findings have shown that the feed rate is the most influential process parameter affecting the feed force, torque and work vibration. In particular, machining with low feed rate can minimize the vibration. The applied forces and their related stresses and strains are also factors for risk assessment as they affect tool vibration, vibration transmission, and biodynamic responses (Dong, Wu & Welcome 2005). Prolonged exposure to intensive tool vibration could cause hand-arm vibration syndrome. Therefore, an effective approach to reduce the hand-arm vibration syndrome is to reduce the intensity of the applied force and the consequent vibration exposure (Dong et al. 2010)

In addition to the current literature, the findings of this study have revealed that a force of approximately 170 N is a threshold limit value beyond which there was little change in

vibration levels or productivity. Furthermore, the case study from this research has shown that the benefit in productivity with high feed force is lower than the benefit in exposure time with low feed force.

The limited range of feed force is not a limitation to this study, i.e. the actual feed force applied by manual workers in construction sites is within the investigated range.

The adopted test bench method is a laboratory-based system that differs from the ISO standard. Since humans do not perform drilling, the system included a foam rubber damping at the coupling to the drill handle designed to be similar to the palm coupling. In addition, a stiff spring isolated the drill from the linear actuator, mimicking the role of the forearm and upper arm. These corrections may lead to handle grip force and force on tip that are similar to work.

The ISO standard calls for drilling downward, but drilling on the test bench was done horizontally to prevent bit binding due to the absence of air flushing of the dust. However, the robotic system minimizes the variance in measures, typical of manual operations.

Finally, further limitations of this study include the utilization of one drill and limited bit diameters. Future developments of this work may include the comparison of the introduced results with the findings from additional tests with different drills and bit diameters.

#### 2.2.3.1.5 Conclusions

This study has investigated the effects of the feed force on handle vibrations and productivity. 48 holes were drilled into concrete blocks using a laboratory based test bench system under feed force control. Handle vibration was collected during drilling.

Results showed a positive correlation between the applied feed force and drilling parameters as the vibrations and drilling rate. In particular, the analysis of the transmitted vibrations suggests that the tool vibration acceleration magnitude is related to the feed force applied by the manual worker during drilling into concrete. The higher the applied force, the higher the exposure to vibrations is.

Similarly, the correlation between feed force and drilling rate suggests that the productivity is related to the feed force applied by the manual worker during drilling into concrete. The higher the applied force, the higher the productivity of the manual worker is.

In particular, increasing feed force increased handle vibration levels and productivity up to a force of approximately 170 N beyond which there was little change in vibration levels or productivity. However, the exposure time limit value strongly decreases with the increasing force.

A case study has shown the productivity and the exposure time variations with different feed force values. Data confirmed that increasing the drilling feed force increases the productivity of manual workers, as well as the exposure to hand-arm vibrations. Despite the benefit in

productivity due to drilling with high feed force, the case study showed that the benefit in exposure time with low feed force is higher. These results suggest that drilling with lower feed force for a longer time is preferred than drilling with higher feed force.

A heuristic criterion has been introduced to define the optimal feed force value for the reference data. The aim was to select a feed force value that maximizes the drilling rate and the exposure time, given the productivity and vibration values. Results showed that a feed force value of approximately 170 N is a good trade-off between the force measurement that allows the maximum exposure time and the force measurement that allows the maximum drilling rate, for the reference case study.

### 2.2.3.2 Concrete drill bit wear patterns and productivity

Concrete drilling is known as one of the most physically demanding tasks in commercial construction (Rempel et al. 2010). Drilling holes into concrete is a common task in construction industry. The use of hammer and rock drills exposes manual workers to hand-arm vibration, noise, silica dust and high hand and arm forces. Prolonged, extensive exposure to hand-transmitted vibration may cause vibration-induced disorders in the vascular, sensorineural, and musculoskeletal structures of the human hand-arm system, known as hand-arm vibration syndrome (Gemne, Taylor 1983, Griffin 1990, Pelmear, Taylor & Wasserman 1992, Kim et al. 2007, Welcome et al. 2015).

Commercial construction workers as plumbers, pipefitters, fire sprinkler installers, electricians, carpenters, and sheet metal workers perform manual activities with vibrating tools for whole work shifts. These workers are exposed to the risk of developing health problems associated with repeated forceful actions and exposures to hand-transmitted vibration.

Rempel, Barr & Antonucci (2015) have investigated the correlation between the vibrations transmitted from drills to construction workers drilling into concrete, and the bit sharpness. The study showed that drilling with dull bits increases the exposure level to hand-transmitted vibration. A focus on the impact of wear on productivity revealed that the drilling time to drill a prescribed distance increases with the bit dullness. In particular, the progressive wear behavior is characterized by an initial period of rapid wear, followed by a growth period (Hamade et al. 2010).

Tool condition monitoring is critical for the improvement of drilling performances in terms of quality of the surface finish and workers productivity. Furthermore, the economical tool life is a function of the wear measurement (Jantunen 2002). Tool changes are frequently made on estimates of tool life, based on personal impressions of skilled workers. The lack of a prescribed method for tool wear measurement during drilling into concrete leads to unnecessary high number of bit changes, loss of time and waste of resources.

This study introduces a method for the assessment and quantification of the bit dullness during drilling into concrete. The aim is to identify the critical parameters for the assessment of bit wear and their correlation with the variation in productivity. The variation of such parameters during concrete drilling defines the progression of the bit wear and the consequent reduction of the drilling performances.

Previous studies introduced different parameters for the analysis of the tool wear (Sinor, Warren 1989, Jantunen 2002, Oraby, Hayhurst 2004, Hamade et al. 2010). The metal cutting literature shows different forms of tool wear, e.g. the flank wear and the crater wear, for the analysis of the tool dullness while drilling (Kanai et al. 1988) and turning (Remadna, Rigal 2006). Sinor and Warren (1989) and Oraby and Hayhurst (2004) analyse the flank wear as the length of the uniform wear-flat on the cutter. In particular, the wear-flat length is based on the height worn off the element and cutter geometry.

A parallel research path investigates the tool wear phenomenon associated with rock abrasion in mining, drilling and tunneling applications (Wise 2003, Zacny, Cooper 2007, Hamade et al. 2010, Alber et al. 2014, Yahiaoui et al. 2016). Hamade et al. (2010) analyzed the variation of the tool flank wear and cutting edge radius, with the variation of drilling parameters as the tool feed and the spindle feed. Alber et al. (2014) have investigated the rock abrasion phenomenon and the wear process as the removal or displacement of material at a solid surface, which lead to tool wear. In their study, the authors analyzed the length or diameter of the wear flat to measure the tool wear. Brandon et al. (1992) have proposed a dull grading system for polycrystalline diamond compact bits for oil drilling tools. The aim of the dull grading system is to facilitate creation of a reference picture of the worn bit's features through a standardized evaluation of the bit characteristics. The grading system quantifies the cutter wear by comparing the initial cutter height with the amount of usable height remaining.

Further studies have investigated the wear process and the wear measurement including both geometrical and physical parameters of the drilling tools. As an example, Ersoy and Waller (1995) and Yan et al. (2016) analyzed the bit height loss and weight loss during drilling into rock.

The following method focuses on the geometrical parameters of the drill bit for the wear measurement during drilling into concrete. The aim is to define the reference values for the critical parameters that ensure high productivity of drilling workers.

The remainder of this Section is as follows. The following Section 2.2.3.2.1 introduces the materials of this study, together with the proposed bit wear analysis method for the assessment of the bit dullness. Section 2.2.3.2.2 investigates the effectiveness of the method through the analysis of the dulling process of four new bits, while Section 2.2.3.2.3 and Section 2.2.3.2.4 discuss the findings and conclusions of this study.

#### 2.2.3.2.1 Materials and methods

The purpose of this study is to identify the critical parameters for the assessment of the bit sharpness and the correlation of the bit dullness with the productivity of construction workers during drilling into concrete with large drills. The following bit wear analysis method assesses the dullness of the drill bit during drilling into concrete. A set of thirteen parameters has been identified to quantify the changes in the bit sharpness after drilling a prescribed distance into concrete. Two different bit shapes have been investigated. In particular, Bit 1 is different from Bit 2, Bit 3 and Bit 4. The following Figure 2.32 and Figure 2.33 show the parameters for a new Bit 1 type, Figure 2.34 and Figure 2.35 show the parameters for a new Bit 2 type, while Bit 3 and Bit 4 are similar to Bit 2. The full list of the parameters is in Table 2.25.



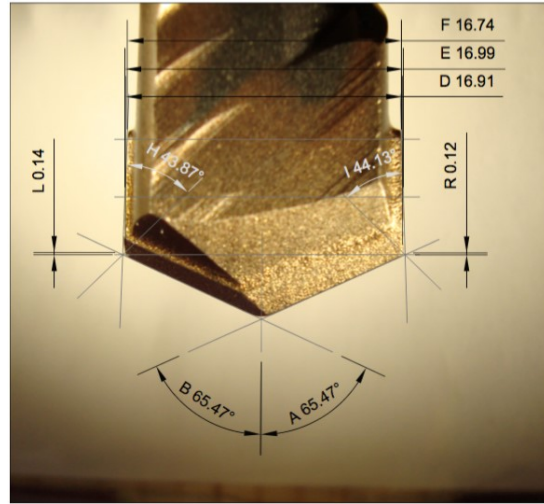
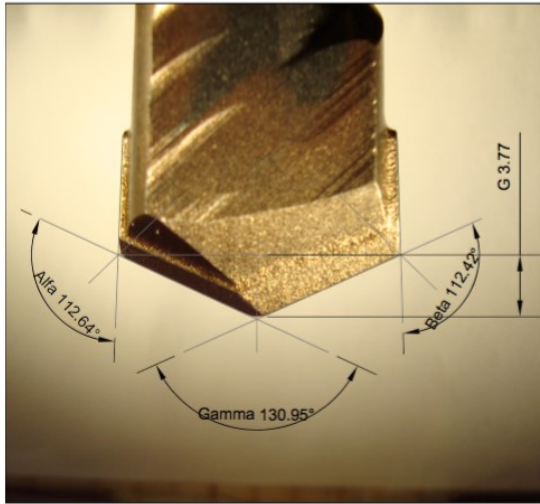

Figure 2.32 and Figure 2.33. Parameters of the proposed wear analysis method for Bit 1.

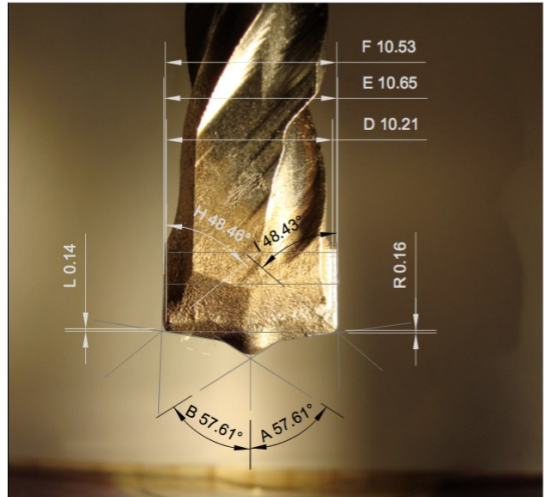
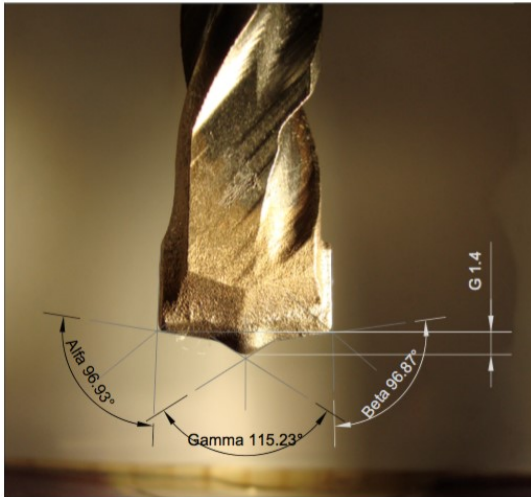

Figure 2.34 and Figure 2.35 Parameters of the proposed wear analysis method for Bit 2, Bit 3 and Bit 4.

Table 2.25 Parameters of the bit wear analysis method.

Parameter	Type
Alfa	Angle [°]
Beta	Angle [°]
Gamma	Angle [°]
D	Distance [units]
G	Distance [units]
A	Angle [°]
B	Angle [°]
E	Distance [units]
F	Distance [units]
H	Angle [°]
I	Angle [°]
L	Angle [°]
R	Angle [°]

The variation of such parameters was monitored during the study.

The test bench system developed by Rempel et al. (2015) performed drilling with an electric hammer drill (TE 70-ATC, Hilti). The average feeding force was controlled by a custom LabView program on a PC. Four different new carbide drill bits have been employed to drill a prescribed drilling distance in concrete blocks. Table 2.26 shows the features of the bits and the details of the drilling process.

The test bench system reproduced the real conditions and actual environment of the operational context within which construction workers perform drilling operations. The bit dulling process involved drilling the prescribed distance into well-aged concrete. The bit wear accumulated during actual testing was considered for the determination of the total bit wear. The total drilling distance is the sum of partial steps at prescribed distances (Table 2.26).

Table 2.26 Drilling process details and features of the four carbide drill bits.

	Bit 1	Bit 2, Bit 3 and Bit 4
Bit type	2-cutter carbide, DeWalt DW5872	-
Bit length [cm]	34.29	30.48
Bit diameter [cm]	1.91	1.27
Drill type	TE 70-AVR, Hilti	TE 40, Hilti
Prescribed feed force [N]	150 N	100 N
Hole depth [cm]	7.62	10.16
Total drilling distance [m]	38.10	15.24
Prescribed distances for each condition [m]	Condition 0: 0 Condition 1: 7.62 Condition 2: 15.24 Condition 3: 22.86 Condition 4: 30.48 Condition 5: 38.10	Condition 0: 0 Condition 1: 7.62 Condition 2: 15.24

A total of five steps were drilled with Bit 1 and two steps were drilled with Bit 2, Bit 3 and Bit 4. Consequently, five conditions were defined for Bit 1 and two conditions identified Bit 2, Bit 3 and Bit 4 (Table 2.26). Pictures of the drill bits were taken with a digital camera before the beginning of the study (Condition 0) and after the prescribed distances. The pictures were analyzed with a PC Software (DraftSight) to quantify the sharpness of the bits and the changes in bit shape. Productivity was measured as the rate of penetration (ROP) [mm/s] of the bit into the concrete (Ersoy, Waller 1995).

#### 2.2.3.2.2 Results

The Figures from 2.36 to 2.38 show the Bit 1 in three different conditions: sharp bit, medium wear bit and dull bit. Specifically, the previous Figure 2.36 shows the new Bit 1 (Condition 0), while the following Figure 2.37 shows the medium wear Bit 1 (Condition 2). Finally, Figure 2.38 shows the dull Bit 1 (Condition 5).



Figure 2.36 New Bit 1 (Condition 0).



Figure 2.37 Bit 1 after drilling 7.62 m (Condition 1).



Figure 2.38 Bit 1 after drilling 38.10 m (Condition 5).

The pictures from Figure 2.36 to Figure 2.38 show a visible variation of the bit shape, due to the dulling process. The values of the investigated parameters and the productivity data for Bit 1 in each condition are in Table 2.27.

Table 2.27 Parameters of the bit wear analysis method and productivity data for Bit 1 in each condition.

	Condition 0	Condition 1	Condition 2	Condition 3	Condition 4	Condition 5	Mean	SD
Alfa [°]	112.64	115.02	115.13	115.95	115.52	116.05	115.05	1.25
Beta [°]	112.42	114.68	115.74	115.87	117.84	118.72	115.88	2.25
Gamma [°]	130.95	126.31	125.82	124.47	121.35	123.69	125.43	3.22
D [units]	16.91	15.18	14.87	14.27	14.09	14.06	14.90	1.08
G [units]	3.77	3.77	3.81	3.69	3.64	3.65	3.72	0.07
A [°]	65.47	63.08	62.35	61.98	61.79	61.69	62.73	1.44
B [°]	65.47	64.01	63.28	62.3	62.15	62.15	63.23	1.33
E [units]	16.99	16.99	16.94	16.82	16.67	16.61	16.84	0.17
F [units]	16.74	16.74	16.74	16.62	16.52	16.51	16.65	0.11
H [°]	43.87	43.87	43.87	43.87	43.87	43.87	43.87	0.00
I [°]	44.13	44.13	44.31	45.82	46.18	46.25	45.14	1.05
L [°]	0.14	0.48	0.58	0.73	0.75	0.77	0.58	0.24
R [°]	0.12	0.54	0.69	0.87	0.9	0.96	0.68	0.32
ROP [mm/s]	9.74	7.43	6.81	6.28	6.48	6.36	7.18	1.32
Feed force [N]	145.09	148.13	150.39	152.16	150.33	150.41	149.42	1.03

The progressive wear behavior is characterized by an initial period of rapid wear, followed by a growth period (Hamade et al. 2010), i.e. the greater variation is visible from Condition 0 to Condition 1 (Table 2.27). The ROP values in Table 2.27 refer to the mean ROP of the first six holes in the reference condition. Similarly, the actual feed force values in Table 2.27 refer to the mean feed force of the first six holes in the reference condition. The variation of the parameters for the analysis of the bit wear confirms the sensible variation of the bit shape due to the dulling process. Furthermore, the values of the ROP decrease from Condition 0 to Condition 5.

Figures from 2.39 to 2.41 show Bit 2 and the investigated parameters for three different conditions: sharp bit, medium wear bit and dull bit. Specifically, the previous Figure 2.39 shows the new Bit 2 (Condition 0), while the following Figure 2.40 shows the medium wear Bit 2 (Condition 1). Finally, Figure 2.41 shows the dull Bit 2 (Condition 2).



Figure 2.39 New Bit 2 (Condition 0).



Figure 2.40 Bit 2 after drilling 7.62 m (Condition 1).



Figure 2.41 Bit 2 after drilling 15.24 m (Condition 2).

The pictures of the bits show a visible variation of the bit shape, due to the dulling process. The greater variation is from Condition 0 to Condition 1.

The values of the investigated parameters and the productivity data for Bit 2, Bit 3 and Bit 4 for each condition are in the following Table 2.28, Table 2.29 and Table 2.30. The ROP values in Table 2.28, Table 2.29 and Table 2.30 refer to the mean ROP of the first six holes in the reference condition. Similarly, the feed force values in Table 2.28, Table 2.29 and Table 2.30 refer to the mean actual feed force of the first six holes in the reference condition.

Table 2.28 Parameters of the bit wear analysis method and productivity data for Bit 2.

	Condition 0	Condition 1	Condition 2	Mean	SD
Alfa [°]	96.93	98.64	100.25	98.61	1.66
Beta [°]	96.87	98.39	100.67	98.64	1.91
Gamma [°]	115.23	114.81	114.86	114.97	0.23
D [units]	10.21	7.51	7.05	8.26	1.71
G [units]	1.4	1.3	1.31	1.34	0.06
A [°]	57.61	56.64	56.03	56.76	0.80
B [°]	57.61	58.17	57.99	57.92	0.29
E [units]	10.65	10.48	10.46	10.53	0.10
F [units]	10.53	10.44	10.37	10.45	0.08
H [°]	48.46	49.74	50.05	49.42	0.84
I [°]	48.43	48.92	49.42	48.92	0.50
L [°]	0.14	0.37	0.42	0.31	0.15
R [°]	0.16	0.45	0.55	0.39	0.20
ROP [mm/s]	9.34	8.98	7.49	8.61	0.98
Feed force [N]	101.30	96.01	90.19	95.83	5.56

Table 2.29 Parameters of the bit wear analysis method and productivity data for Bit 3.

	Condition 0	Condition 1	Condition 2	Mean	SD
Alfa [°]	98.96	99.8	100.59	99.78	0.82
Beta [°]	97.84	99.9	100.21	99.32	1.29
Gamma [°]	115.74	114.36	116.08	115.39	0.91
D [units]	10.08	8.71	7.69	8.83	1.20
G [units]	1.43	1.43	1.38	1.41	0.03
A [°]	57.87	57.81	57.91	57.86	0.05
B [°]	57.87	56.38	58.17	57.47	0.96
E [units]	10.62	10.61	10.56	10.60	0.03
F [units]	10.55	10.53	10.5	10.53	0.03
H [°]	49.48	49.48	49.48	49.48	0.00
I [°]	49.12	49.53	49.12	49.26	0.24
L [°]	0.12	0.22	0.34	0.23	0.11
R [°]	0.14	0.35	0.46	0.32	0.16
ROP [mm/s]	9.64	7.98	7.59	8.40	1.09
Feed force [N]	94.97	96.41	87.86	93.08	4.58

Table 2.30 Parameters of the bit wear analysis method and productivity data for Bit 4.

	Condition 0	Condition 1	Condition 2	Mean	SD
Alfa [°]	98.74	99.52	101.32	99.86	1.32
Beta [°]	98.28	100.24	100.96	99.83	1.39
Gamma [°]	116.08	116.98	117.27	116.78	0.62
D [units]	10.09	8.21	6.77	8.36	1.66
G [units]	1.44	1.38	1.27	1.36	0.09
A [°]	58.04	57.96	58.75	58.25	0.43
B [°]	58.04	59.02	58.52	58.53	0.49
E [units]	10.59	10.57	10.58	10.58	0.01
F [units]	10.53	10.51	10.51	10.52	0.01
H [°]	49.37	49.37	49.37	49.37	0.00
I [°]	49.14	49.14	49.98	49.42	0.48
L [°]	0.1	0.31	0.41	0.27	0.16
R [°]	0.12	0.39	0.48	0.33	0.19
ROP [mm/s]	9.91	8.30	7.66	8.62	1.16

Feed force [N]	97.87	89.53	89.73	92.38	4.76
----------------	-------	-------	-------	-------	------

The variation of the parameters for the analysis of the bit wear confirms the sensible variation of the shape of the bits due to the dulling process (Table 2.28, Table 2.29 and Table 2.30). Furthermore, the values of the ROP for each bit decrease from Condition 0 to Condition 2.

The following Section 2.2.3.2.3 shows the discussion of the introduced results and the analysis of the correlation between the changes in the bit sharpness and the variation of productivity.

#### 2.2.3.2.3 Discussion

The pictures of the bits and the values of the introduced parameters for the analysis of the bit wear in Section 2.2.3.2.2 confirm a sensible variation of the bit shape, due to the dulling process.

The following Table 2.31 shows the values of the coefficient of correlation  $R^2$  for the investigated parameters and the productivity of the drilling process.

Table 2.31 Coefficient of determination  $R^2$  for the bit shape parameters and productivity.

	Productivity					
	<i>Bit 1</i>	<i>Bit 2</i>	<i>Bit 3</i>	<i>Bit 4</i>	<i>Mean</i>	<i>SD</i>
Alfa [°]	0.974	0.854	0.923	0.843	0.899	0.06
Beta [°]	0.742	0.934	0.989	0.994	0.915	0.12
Gamma [°]	0.826	0.286	0.012	0.989	0.528	0.46
D [units]	0.969	0.523	0.955	0.989	0.859	0.22
G [units]	0.278	0.302	0.463	0.882	0.481	0.28
A [°]	0.989	0.766	0.012	0.487	0.564	0.42
B [°]	0.915	0.119	0.020	0.410	0.366	0.40
E [units]	0.422	0.484	0.618	0.421	0.486	0.09
F [units]	0.382	0.814	0.839	0.888	0.731	0.23
H [°]	-	0.572	-	-	0.572	-
I [°]	0.477	0.870	0.086	0.579	0.503	0.32
L [°]	0.960	0.556	0.882	1.000	0.850	0.20
R [°]	0.949	0.635	0.986	0.990	0.890	0.17

The highest correlation is between productivity and parameter L for Bit 4, while the lowest correlation is between productivity and coefficient A for Bit 3. No correlation is estimable between productivity and parameter H for Bit 1, 3 and 4, i.e. parameter H is constant for these bits during drilling.

The mean values in Table 2.31 show high correlation between productivity and parameters Alfa, Beta, D, L and R. These results suggest that the variation of such parameters has a sensible impact on the performances of the drilling process. Consequently, Alfa, Beta, D, L and R are critical parameters to monitor for the improvement of the drilling performances.

These results confirm the previous studies on progressive wear behavior (Taylor 1907). This phenomenon is characterized by an initial period of rapid wear followed by a growth period. This rapid initial wear followed by a uniform wear rate is common in metal cutting and rock cutting (Hough Jr., Das 1985, Hamade et al. 2010).

Several factors control the wear characteristics of the bits, however, the principal factors which need to be considered in predicting wear rates are the bit features, the bit operating parameters and the characteristics of the penetrated material (Ersoy, Waller 1995).

Previous studies have monitored the weight loss of the drilling tool due to the wear process (Ersoy, Waller 1995, Yan et al. 2016). The analysis of the bit weight loss gives a proportion of the wear rate, regardless the wear location and the variation of the bit features. The aim of the proposed method is to analyze the bit wear process and the variation of critical parameters that ensure high productivity of the drilling operations. Therefore, the investigated parameters depend on the geometry of the drilling tool.

In their study, Yahiaoui et al. (2016) measured the final worn height to compute the wear volume. The wear mechanism and the geometry of the drilling tool are complex. Different areas of the drilling tool show different variations due to the wear process. The combined analysis of several parameters gives a reliable measure of the wear mechanism.

The recent literature proposes the analysis of the flank wear and cutting edge radius to measure the wear process (Oraby, Hayhurst 2004, Remadna, Rigal 2006, Hamade et al. 2010). The acquisition and the analysis of these parameters require specific equipment and microscope technology. Such technologies are not available on construction sites. Furthermore, the geometry of drilling tools is extremely variable and workers adopt different types of bits. This method investigates the specific features of the bits to identify the parameters that have a sensible impact on the performances of the drilling process.

The definition of threshold limit values for such critical parameters provides a measure for the bit life that ensures high productivity of the drilling operations. Employers and workers might compare the bit wear conditions with the identified threshold limit values on construction sites to identify the limit dull bit shape and deciding when the bit change is desirable. The values of the investigated parameters might address the design of a limit dull bit shape for workers on construction sites. Bits that reach the limit dull bit shape might be replaced with new bits during construction work to improve the performances of drilling operations.

The results of this study are limited to the investigated bit shapes. Several bit shapes are employed in construction sites, depending on the type of material, equipment and other characteristics of the construction work. Therefore, it is difficult to define a unique limit dull bit shape. This study might be repeated with different bit shapes to create a substantial database of limit dull bit shapes for construction work. Furthermore, the measure of the proposed parameters is simple. No particular tools or equipment are needed, except for a digital camera to take the pictures of the bit and a computer software to analyze the images. The measurements are repeatable and the accuracy of the method mostly depends on the quality of the images.



#### 2.2.3.2.4 Conclusions

The cost of the drilling process mainly depends on the drilling rate, which is heavily influenced by the wear condition of the bits. Consequently, bit wear is a major factor in determining the bit life and the overall cost of drilling (Ersoy, Waller 1995).

This Section has introduced a method for the analysis of the bit wear process during drilling into concrete with drills. The aim was to define a method to assess the wear mechanism of drilling tools and improve the productivity of drilling workers.

The proposed method has been tested with four bits to analyze the dulling process. Pictures of each bit have been taken during the test to analyze the bit sharpness and the dulling process during drilling. The visual analysis of the pictures showed a visible variation of the bit shape due to the bit wear phenomenon. A set of thirteen parameters has been identified to quantify the bit wear during the dulling process. The variation of the thirteen parameters confirmed the bit shape variation due to the bit wear phenomenon. Productivity has been monitored during the test as the rate of penetration of the bits into concrete. Results showed high correlation between productivity and parameters Alfa, Beta, D, L and R. The variation of such critical parameters has a sensible impact on the performances of the drilling process. Furthermore, Alfa, Beta and D are easy to measure. Construction companies and drilling operators should monitor these critical parameters during drilling into concrete to improve the performances of the drilling operations.

The introduced bit wear analysis method addresses the definition of threshold limit values for the bit life that ensure high productivity of the drilling operations. Future developments of this study include the design of a limit dull bit shape to help construction companies and drilling operators in deciding when the bit change is desirable. Finally, the dependence of the proposed parameters on the independent variables of drilling work (e.g. tool feed, rotational speed and concrete type) might be investigated.

## 2.3 ENGINEERING CONTROLS FOR ERGONOMICS

The international standards on occupational safety recommend the use of control methods for the elimination or the reduction of the identified hazards. As presented in Figure 2.2, the hierarchy of controls includes engineering controls, administrative controls and Personal Protective Equipment (PPE). The most effective protective measure is to eliminate the hazards without shifting them elsewhere. When the hazard elimination is not possible, engineering controls are the preferred measure to protect the workers from exposure to hazards. This chapter introduces a procedure for planning the implementation of engineering controls to support the risk elimination or reduction is introduced, together with two practical applications on different industrial workplaces. The ergonomic risk assessment before the introduction of the engineering controls has revealed some major risk factor associated with WMSDs. After the adoption of the solutions, the achieved ergonomic improvements led to the reduction of the risk factors.

Based on the PDCA (plan-do-check-act) management method (Deming 1986), the proposed stepwise procedure begins with an initial risk assessment. In particular, the initial analysis allows the effective identification of the primary preventive measures for disergonomics and for the most evident risk factors. Each step guides the workers and all the personnel involved through the effective application of the control measures to improve the ergonomics of manual activities.

The effectiveness of the procedure is tested with two industrial applications. The first case study shows the application of an engineering control measure for the risk reduction in the meat-processing industry. Manual activities in the meat-processing industry involve significant stress of the back and the upper limb. The introduction of a semi-automatic industrial manipulator has reduced the ergonomic risk of the analyzed manual activity, showing a significant decrease of the risk index. The second case study shows the introduction of an engineering control measure for the risk elimination in the retail apparel industry. The procedure guides the Technical Committee and the personnel involved through the introduction of a semi-automatic handling and lifting device to replace workers performing a high-risk manual-handling task.

The results from the case studies confirm the success of the procedure for the effective application of risk control measures, regardless of industry. Consequently, the proposed procedure is a helpful tool for employers and practitioners facing the problem of disergonomics in the workplace.

### 2.3.1 Procedure for the introduction of engineering controls in industry

The effective management and elaboration of the design or re-design of an ergonomic workplace and the adoption of preventive organizational and procedural solutions are related to the company's ability to define a proper procedure for the management of the whole preventive strategy. The technical regulations on ergonomics support the procedure for the definition of preventive strategies for the reduction of the ergonomic risk. Such regulations address company towards the realization of the best working conditions, chasing two primary objectives: the realization of an efficient workplace in terms of product quality and productivity, and the protection of workers' safety and health.

To support the aforementioned regulations in Section 2.1.1, further standards help in defining and optimizing the procedure for the definition of an effective preventive strategy (e.g., the ISO 6385 on the ergonomic design of work systems, the ISO 11064 series, and the ISO 9241-11 on the concept of "usability," the procedure for the "task analysis" and the worker-centered approach, known as the "User/Human Centered Design"). In particular, the task analysis defines the user tasks and subtasks, explaining the methods and identifying the aspects that impact on quality and safety. The characteristics of the tasks, which may influence usability, should be described, identifying the physical and mental demands, the required equipment, the objects to handle and the organizational context (e.g., the frequency and the duration of the task). The human-centered design philosophy investigates the optimization of the machine-user relationship within the specific organizational and environmental contexts.

The regulations in force and the previous literature widely investigate the application of the ergonomic principles in workplaces. However, multiple risk factors contribute to the development of injuries and work-related disorders affecting the whole musculoskeletal system. The adoption of an effective tool for the management of each risk factor is necessary to master such difficult scenario and to ensure the optimal application of the control measures.

Previous studies have shown that occasional interventions and improperly designed actions are ineffective (Zecchi, Menoni 2006). Vice versa, an effective preventive strategy aiming to address the potential ergonomic risks is the product of critical decisions made by top management. Furthermore, the adoption of control measures for ergonomics and for the management of identified problems might produce potential threats to workers' health and safety. As an example, the adoption of a semi-automatic industrial manipulator for manual material handling eliminates the load on the vertebral column. At the same time, the manipulator might cause awkward postures of the shoulders and arms, or reduce the clearance of the re-designed workstation (Attaianesi, Duca 2008).

Routines and resistance to change are additional factors that hinder the benefits of the control measures, despite the promising improvement of the work conditions. The choice of technical aids, equipment and preventive measures must follow a specific procedure.

This section introduces a procedure for the effective introduction of control measures for ergonomics. Based on the PDCA (plan-do-check-act) management method (Deming 1986), the following procedure begins with an initial risk assessment and includes the steps in Figure 2.42.

Risk assessment is not only the evaluation of a risk index. The ISO/TR 12295 (2014) defines an assessment procedure including several key questions and a quick assessment for the ergonomic analysis of the job conditions. Such analysis allows the effective identification of the primary preventive measures for “disergonomics” and for the most evident risk factors.

PROCEDURE	PERSONNEL INVOLVED				
	EMPLOYER AND MANAGEMENT	SAFETY COORDINATOR	OCCUPATIONAL HEALTH SPECIALIST	FIRST-LINE SUPERVISOR	WORKERS
1. Problem identification	✓	✓		✓	✓
2. Nominee of the Technical Committee	✓	✓			
3. Reunion of the Technical Committee					
3.1 Screening of the alternatives and choice of the solution	✓	✓			✓
3.2 Plan of the intervention					
3.3 Definition of the formation and training programs					
4. Intervention and adoption of the solution		✓		✓	✓
5. Actuation of the formation and training programs		✓		✓	✓
6. Check and analysis of the results			✓	✓	✓
6.1 If the check is ok, then perform a task analysis after 6/12 months		✓		✓	✓
6.1.1 Repeat Step 6.1 until check is not ok					
6.2 If the check is not ok, go to Step 1					

Figure 2.42 Procedure for the introduction of control measures for ergonomics.

In particular, the following positions are involved in the procedure for the management of the control application:

- *employer and management*: person/people with decisional power, in charge of the employment relationship with the worker. The employer (or the management) is responsible for the company where the worker performs the job activity;
- *safety coordinator*: the coordinator of the preventive and protective services. The employer nominates the safety coordinator, assessing his abilities and the specific professional requirements;
- *first-line supervisor*: the supervisor of the job activity. The first-line supervisor guarantees the application of the received guidelines, checking the proper execution;

- *workers*: people performing the job activity, with or without compensation, within the organization of the public or private employer. In particular, the employee representative is an employee elected or named to represent workers for occupational health and safety issues.

Such definitions are from the Italian regulation in force on occupational health and safety (Ministero del Lavoro e delle Politiche Sociali 2008). The personnel involved directly participate in the process, providing useful suggestions and opinions in every step of the procedure.

The following steps define the proposed procedure for the management of the control application.

### 1. Problem Identification

The problem is the ergonomic criticality that requires the adoption of control measures. The company performs the initial risk assessment identifying the problem, the causes and determining the level of risk: *“The risk assessment through the method/index \_\_\_\_\_ enables the identification of the disergonomic situation and the control measures for the risk elimination/reduction. The method used to identify the problem is suitable for the investigated activities, work-related injuries, illnesses and musculoskeletal disorders due to biomechanical overload.”*

Personnel involved: employer and management, safety coordinator, first-line supervisor and workers.

### 2. Nominee of the Technical Committee

The Technical Committee (TE) is a group of expert operators (internal or external) involved in the process: *“The TE, lead by the employer, may include the following figures: production manager for production and organizational data, safety coordinator/external consultant for the application of the ergonomic principles in the workplace and the preventive measures proposal, the occupational medicine specialist for the synergy with the workers health data. The TE consults the workers and their representative, providing information for the proactive participation in the process.”*

Personnel involved: employer and management, safety coordinator.

### 3. Reunion of the TE

#### 3.1. Screening of the Alternatives and Choice of the Control

The group of expert operators screens the potential alternatives for the identified problem. The choice of the intervention is up to the employer, who defines priorities and schedule: *“Based on the following considerations \_\_\_\_\_ and objectives \_\_\_\_\_ the TE proposes the adoption of the following preventive measure \_\_\_\_\_. The following operators \_\_\_\_\_ will use the proposed solution to perform the following activity \_\_\_\_\_ and task \_\_\_\_\_ for the operations \_\_\_\_\_.”* Alternatively, the TE provides specific control measures for each department: *“The following preventive measures are adopted for carpentry workers \_\_\_\_\_,”* or *“The following preventive measures are adopted for assembly workers \_\_\_\_\_,”* or *“The following preventive measures are adopted for painting workers \_\_\_\_\_,”* or *“The following preventive measures are adopted for workstation/task \_\_\_\_\_,”* etc.

### 3.2. Plan of the Intervention

The planning phase sets the steps for the realization of the intervention, providing a predefined sequence of actions and time schedule.

### 3.3. Definition of the Formation and Training Programs

The steps include all the necessary actions for the optimal adoption of the control measure, from the formation and training of users to the full application of the solution. *“All the workers (or the following workers) \_\_\_\_\_ who will make use of the selected control measure, will be involved in the formation program (n. \_\_\_\_ hour session) about \_\_\_\_\_. The same workers will be involved in the training program on the \_\_\_\_\_ (mm/dd/yyyy). The training session will provide all the instructions and the producer user’s guide for the proper use of the control.”* New employees will follow a dedicated formation and training program according to the following methods \_\_\_\_\_.”

Personnel involved: employer and management, safety coordinator and workers.

## 4. Intervention and Adoption of the Solution

The solution is introduced as described in the initial plan, following the defined methods and schedule.

Personnel involved: safety coordinator, first-line supervisor and workers.

## 5. Actuation of the Formation and Training Programs

The formation and training programs start after the purchase of the solution. The actuation procedure follows the plan and schedule defined in Step 4. The solution is activated once the formation and training programs are completed.

Personnel involved: safety coordinator, occupational health specialist, first-line supervisor and workers.

## 6. Check and Analysis of the Results

Define the assessment method to verify the effective adoption of the solution. The analysis is performed investigating the results from an ergonomics point of view and verifying the contribute to reduce or eliminate the risk of biomechanical overload.

Identify the steps to improve the results. After the conclusion of the intervention, monitor the system to supervise the proper operation. Ensure continuous improvement through the application of simple corrective actions to prevent possible undesired effects and optimizing the intervention. Such actions include the measurement of the obtained results compared with the initial objectives and the collection of suggestions and opinions from the users and the personnel involved.

### 6.1. *If the Check Is Ok, Then Perform a Task Analysis after 6/12 Months*

The task analysis aims to measure and assess potential spontaneous adjustments performed by the operators: *"The proper adoption of the solution, the correct utilization and the respect of the introduced control measure are constantly supervised. The following supervisors \_\_\_\_\_ as \_\_\_\_\_ (safety coordinator/ workers representative/etc.) will perform regular and periodic monitoring every \_\_\_\_\_ weeks/months. Unwanted behaviors and improper actions will be punished, according to the following measures \_\_\_\_\_."*

#### 6.1.1. *Repeat Step 6.1 Until Check Is Not Ok*

The task analysis is repeated every 6/12 months, unless supervisors detect irregular situations or problems related to the adoption of the control measure.

### 6.2. *If the Check Is Not Ok, Go To Step 1*

If the task analysis reveals the presence of an irregular situation, or a problem hindering the expected improvements, than TC should review the adopted solution and repeat the entire procedure.

Personnel involved: safety coordinator, first-line supervisor and workers.

### 2.3.1.1 Practical Applications for Industry

This Section presents two applications of the introduced procedure. Two case studies test the procedure for the introduction of engineering controls to improve the ergonomics of manual activities. In particular, the first case study is from the meat-processing industry. The description of a high-risk manual handling is introduced in Section 4.1, together with the steps for the application of an engineering control for the risk reduction. The second case study is from the retail apparel industry (Section 4.2). The presented procedure is applied to address the introduction of an engineering control to eliminate the risk from manual handling tasks.

#### 2.3.1.1.1 Case Study 1: Application of an Engineering Control in the Meat-Processing Industry

An Italian meat-processing company produces sausages and typical Italian cotechino from the mix of different types of pork meat. Raw meat arrives from the supplier on metal trays of 35 – 45 kg. Trays are arranged on stacks about 170 cm tall (10 full trays/stack) and stored into the refrigerating room (Figure 2.43). Stack retrieval from the refrigerating room to the blending area is performed by means of a forklift truck. The meat blending process starts with the preparation of a meat mixture into a blending machine.

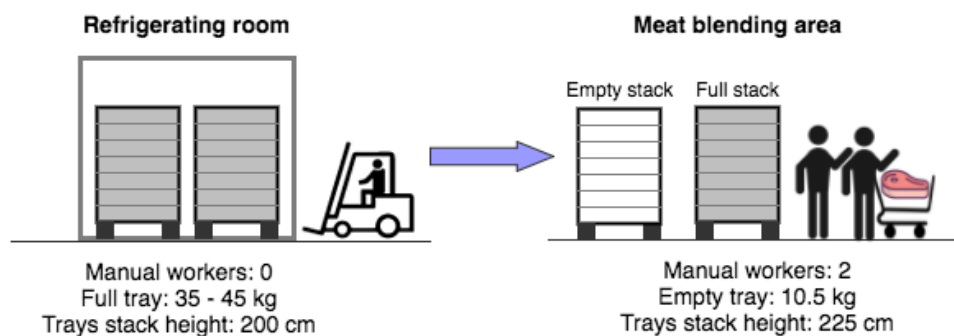

Figure 2.43 Preparation of the meat mixture for the blending machine.





Figure 2.44 Workers unloading full trays into the carts.

Two manual workers unload raw meat from the full stack of trays into special cart to feed the blending machine (Figures 2.43 and 2.44). The weight of each full tray is between 35 and 45 kg, while full carts weigh 200 kg. The height of the full stack is about 250 cm (15 empty trays/stack). After unloading, empty trays (10.5 kg) are manually stacked on piles of similar height (Figures 2.43 and 2.44). Unloading job is performed for 2 – 3 hours per day, in the morning.

The risk assessment for the unloading task has highlighted the presence of biomechanical overload of back and upper limb due to manual handling of loads over 3 kg. Such work conditions suggest the adoption of an engineering control to improve the ergonomics of the analyzed task. The following is the implementation of the proposed procedure for the application of the engineering control.

### 1. Problem Identification

Employer, occupational health specialist, safety coordinator and workers representative perform the ergonomic analysis of the unloading task. The ergonomic risk assessment reveals high risk of biomechanical overload of back, upper limb and shoulders.

The risk of repetitive movements of the upper limb is analyzed with the OCRA checklist method (ISO 11228-3 2007). The OCRA checklist value for the left arm is 23 (high risk), while the value for the right hand is 20 (medium risk). Such values invert when the worker switches the arms to perform the same activity.

The risk assessment of the lifting tasks is performed through the Revised Niosh Lifting Equation (Waters 1993). The results reveal a VLI of 3.14, which confirms the high-risk due to the trays unloading activity. In particular, the presence of two operators to halve the handled weight is not a measure for the risk reduction. The lifted weight reduces from 45, 35 and 10.5

kg to 26.5, 20.5 and 6 kg. In particular, the EN 1005-2 provides directions to evaluate the actual lifted weight for two people handling the same load. Such standard applies a corrective factor (0.85) amplifying the average handled weight (e.g.,  $45 \text{ kg} / 2 / 0.85 = 26.5 \text{ kg}$ ).

## 2. Nominee of the TC

Employer, production manager and safety coordinator nominate the TC. The following employees compose the team: safety coordinator, workers representative, external consultant expert on ergonomics, blending area supervisor.

## 3. Reunion of the TC

### 3.1. Screening of the Alternatives and Choice of the Control

The TC alternates two meetings with several surveys on the field. The surveys highlight evident disergonomics and reduced clearance due to the presence of fixed machines and plants. Given the characteristics of the task and the work environment, the TC chooses to install the customized semi-automatic manipulator in Figures 2.45 and 2.46.



Figure 2.45 Semi-automatic manipulator in the blending area.

The engineering control in Figure 2.45 assists the worker while reducing the ergonomic risk for the back and the disergonomics for the upper limb. The particular gripping system with multiple control of the manipulator improves the posture of the shoulder. Such system allows the operator to perform a wide range of movements with the arms. Furthermore, the retrieval of the full trays and the deposit of the empty trays on high stacks are performed assuming a comfortable posture (Figure 2.46). Consequently, the ergonomic risk is significantly reduced, despite the manual operation is not eliminated.



Figure 2.46 Tray unloading with the semi-automatic manipulator.

### *3.2. Plan of the Intervention*

The TC contacts the supplier or the manufacturer of the solution to define the plan of the intervention. The design of the manipulator, the realization of the customized parts and the installation in the plant requires four months.

### *3.3. Definition of the Formation and Training Programs*

The TC plans a training day for the personnel involved. The program of the training day includes a theory session of two hours, followed by a two-hours practical session. The four workers performing the unloading task are involved in the program. The safety coordinator and the occupational health specialist deliver the formation program to the workers, while the workers representative is responsible for the training session. The program ends with a post-training test that verifies the knowledge and the abilities of the personnel involved.

## 4. Intervention and Adoption of the Solution

The intervention is performed as planned in Step 3.2. The manipulator works at full speed following the pre-defined time schedule. The personnel involved are provided with a dedicated practical guideline addressing the proper utilization of the solution.

## 5. Actuation of the Formation and Training Programs

The formation and training programs are performed as planned in Step 3.3. After the post-training tests, the supervisor certifies the positive results and closes the intervention. The four workers adopt the solution, following the directions of the practical guideline.

## 6. Check and Analysis of the Results

Safety coordinator, first-line supervisor and workers verify the ergonomic impact of the solution, identifying the contribute to reduce the risk for biomechanical overload.

The application of the risk assessment methods in the ISO/TR 12295 reveals an acceptable risk for both the back and the upper limb. Finally, the supervisor of the blending area monitors the proper utilization of the solution, ensuring the respect of the directions in the practical guideline.

### *6.1. If the Check Is Ok, Then Perform a Task Analysis after 6/12 Months*

The safety coordinator, the external consultant and the workers representative perform an initial check two months after the conclusion of the intervention. Further periodic checks are scheduled every 6 months. The occupational health specialist certifies the workers' fitness to work every year, assessing the improvements in their safety and health.

#### *6.1.1. Repeat Step*

*6.1. until check is not ok*

*6.2. If the check is not ok, go to Step 1*

### 2.3.1.1.2 Case Study 2: Application of an Engineering Control in the Retail Apparel Industry

An Italian retail apparel company stocks and supplies sport clothes, shoes and fitness accessories for an Italian athletic apparel franchise. Manual workers prepare the orders for customers by picking the products from the warehouse and placing them into plastic carts. Carts are about 70 cm tall. After completing the order picking, workers empty the full cart in a hopper (Figure 2.47). The hopper feeds a conveyor system with a sorter for the automatic sorting of clothes, shoes and accessories. The speed of the conveyor is 2 m/s, while the sorter sorts about 10,000 items per hour.

Manual order picking is performed several times per shift. The risk assessment revealed the presence of biomechanical overload of back and upper limb due to manual emptying of the carts. Such activity involves repetitive movements of the upper limb and awkward postures of shoulders, elbow, wrist and hand. Furthermore, workers assume a static position, maintaining

a back flexion posture for several minutes while emptying the carts or handling loads over 3 kg (Figure 2.48).

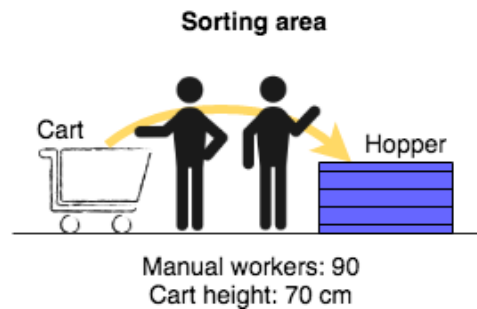

Figure 2.47 Cart emptying in the sorting area.



Figure 2.48 Manual worker performing cart emptying.

Such work conditions suggest the adoption of an engineering control to improve the ergonomics of the analyzed task. The following is the implementation of the proposed procedure for the application of the engineering control.

#### 1. Problem Identification

Employer, occupational health specialist, external safety coordinator and workers representative perform the ergonomic analysis of cart emptying. Workers maintain the back flexion posture for more than the maximum time allowed (one minute) while emptying the carts (ISO 11226). The simplified ergonomic risk assessment from the ISO/TR 12295 has revealed high risk for the upper limb and back. In particular, the high-risk condition is due to the static back flexion posture, rather than the manual handling of the items.

## 2. Nominee of the TC

Employer, production manager and external safety coordinator nominate the TC. The following employees compose the team: external safety coordinator, workers representative, external consultant expert on ergonomics, sorting area supervisor.

## 3. Reunion of the TC

### 3.1. Screening of the Alternatives and Choice of the Control

Given the evident disergonomics of cart emptying and the difficult interaction between the operator and the cart, the TC chooses to install the customized semi-automatic handling and lifting device in Figure 2.49.



Figure 2.49 Semi-automatic handling and lifting device in the sorting area.

The engineering control in Figure 2.49 lifts the containers to a predefined height, allowing the workers to empty the carts in upright posture with an acceptable arm position.

Consequently, the device eliminates the ergonomic risk for the back due to the static back flexion posture.

### 3.2. Plan of the Intervention

The TC contacts the supplier or the manufacturer of the solution to define the plan of the intervention. The design of the manipulator, the realization of the customized parts and the installation in the plant requires two months.

### *3.3. Definition of the Formation and Training Programs*

The TC plans one or two training day for the personnel involved, based on the availability of the workers and the work shifts. The program of the training day includes a theory session of one hour, followed by a thirty-minutes practical session. The ninety workers performing cart emptying are involved in the program. The external safety coordinator delivers the formation program to the workers, while the workers representative and the sorting area manager are responsible for the training session. No post-training test is required to verify the knowledge and the abilities of the personnel involved.

### *4. Intervention and Adoption of the Solution*

The intervention is performed as planned in Step 3.2. The semi-automatic handling and lifting device works at full speed following the pre-defined time schedule.

### *5. Actuation of the Formation and Training Programs*

The ninety workers assigned to order picking tasks participate in the formation and training programs as planned in Step 3.3. The programs start the day after the installation of the device in the sorting area.

### *6. Check and Analysis of the Results*

The supervisor of the sorting area monitors the proper utilization of the solution.

#### *6.1. If the Check Is Ok, Then Perform a Task Analysis after 6/12 Months*

The safety coordinator, the external consultant and the workers representative perform an initial check two months after the conclusion of the intervention. Further periodic checks are scheduled every 6 months. The occupational health specialist certifies the workers' fitness to work every year, assessing the improvements in their safety and health.

##### *6.1.1. Repeat Step 6.1 until check is not ok*

#### *6.2. If the check is not ok, go to Step 1*

During the training program and after the installation of the solution, the personnel involved have noticed potential improvements of the device to enhance the biomechanical risk reduction. The features of the device do not allow the complete cart overturn, as the width of the cart is larger than the hopper of the sorter. In particular, the 180-degree turn of the cart

causes the discharge of the items out of the hopper. Consequently, the utilization of the device is limited to lifting tasks. The device tilts the cart by 90 degrees and manual workers perform upper limb repetitive movements to empty the containers.

The check is not ok and the procedure restarts from Step 1.

### 1. Problem Identification

The external safety coordinator and the workers representative verify the impossibility to overturn and empty the cart into the hopper without dropping any items. The device lifts the cart allowing the operator to assume an upright posture while emptying the cart. Despite the ergonomic improvement for the back posture, repetitive movements of the upper limb are still present.

### 2. Nominee of the TC

The following employees compose the TC: external safety coordinator, workers representative, external consultant expert on ergonomics, sorting area supervisor.

### 3. Reunion of the TC

#### *3.1. Screening of the Alternatives and Choice of the Control*

The observation of the solution during its first application for cart emptying suggests making changes to the initial configuration of the device. The TC decides to apply two lateral barriers on the gripper of the semi-automatic lifting and handling device (Figure 2.50).

The barriers narrow the opening of the cart, preventing the items to fall outside the hopper during cart emptying. Consequently, the manual worker is not necessary to empty the cart and the ergonomic risk is deleted.





Figure 2.50 Semi-automatic lifting and handling device with lateral barriers.

### *3.2. Plan of the Intervention*

The TC contacts the manufacturer of the solution to define the plan of the intervention. The design of the barriers, the realization of the customized parts and the installation on the semi-automatic lifting and handling device requires one week.

### *3.3. Definition of the Formation and Training Programs*

The TC plans one or two training day for the personnel involved, based on the availability of the workers and the work shifts. The sorting area manager, delivers an additional 15-20 minutes training session to the personnel involved. The workers representative takes part in the training sessions.

## 4. Intervention and Adoption of the Solution

The intervention is performed as planned in Step 3.2. The modified semi-automatic handling and lifting device works at full speed following the pre-defined time schedule.

## 5. Actuation of the Formation and Training Programs

The workers assigned to manual order picking participate in the formation and training programs as planned in Step 3.3. The programs start the day after the installation of the device in the sorting area.

## 6. Check and Analysis of the Results

The intervention has deleted the manual task and cart emptying is automatic. Carts containing special items (e.g., shoes boxes) require the manual operator to realize the transfer to the hopper. In these cases, the device lifts and turns the cart while the manual operator empties the contents assuming an acceptable posture of back and arms. The application of the risk assessment methods in the ISO/TR 12295 reveals an acceptable risk for both the back and the upper limb. Finally, the supervisor of the blending area monitors the proper utilization of the solution, ensuring the respect of the directions in the practical guideline.

6.1. If the Check Is Ok, Then Perform a Task Analysis after 6/12 Months

The sorting area manager continuously verifies the proper utilization of the device during the work shifts. The safety coordinator, the external consultant and the workers representative perform an initial check two months after the conclusion of the intervention. Further periodic checks are scheduled every 6 months. The occupational health specialist certifies the workers' fitness to work every year, assessing the improvements in their safety and health.

*6.1.1. Repeat Step 6.1 until check is not ok*

*6.2. If the check is not ok, go to Step 1*

## 2.3.2 Integrating automation in typical manual processes

Meat processing is a labor-intensive industry dealing with manual handling of heavy loads of meat at high frequency. Meat processing workers are under pressure to maintain high rates of work, performing arduous repetitive motions while keeping awkward postures. Ergonomic risk assessments reveal that manual material handling and repetitive tasks expose meat-processing workers to high physical risk.

This Section investigates the impact of engineering controls as automated technology on manual ham-deboning lines in the meat-processing industry. The aim is to study the effects of automation on the work system and layout, analysing the economic and ergonomic impact of semi-automatic ham deboning lines.

The study introduces a non-safety cost model for the comparative and sensitive analysis of manual and semi-automatic ham deboning systems, including the cost of non-safety. The model is tested with a case study from an Italian ham processing company. The reference manual ham-deboning line is introduced, together with a new layout proposal involving the adoption of a semi-automatic ham-deboning machine. Results reveal the positive impact of the semi-automatic ham-deboning system on the company's profitability and workers' ergonomics. As a consequence, automated technology leads to economic and ergonomic benefits for workers, employers and customers.

### 2.3.2.1 The ergonomic risk in the meat-processing industry

Work activities in the meat processing industry are both technically and physically demanding. Meat processing workers perform a wide range of tasks, involving manual handling of heavy loads, e.g. whole carcasses, at high frequency. Common activities include lifting, moving, turning and twisting heavy carcasses among the workstations. Other tasks involve laborious and frequent movements to cut the carcass, whilst holding the loads. Such repetitive motions are a common cause of occupational diseases, as the well-known musculoskeletal disorders. In addition, the work environment is characterized by noise, humidity, cold and offensive odors. These characteristics make the meat processing industry both physically and emotionally demanding. As a consequence, slaughterhouse work is not an attractive option for prospective employees, particularly young people. To improve the working environment and hinder the potential insufficiency in the labor force, the meat processing industry is automating the most labor-intensive parts of the work process (Purnell, Caldwell 2012, Clarke, Nielsen & Madsen 2014). Automated meat processing reduces arduous repetitive work, whilst replacing some heavy activities with less-intensive tasks, e.g. planning and controlling the new technology (Nielsen, Fertin & Christensen 2005, Barbut 2014). Furthermore, the increasing international competition is pressuring the meat processing industry to automate the meat process and develop more efficient production

methods. A recent study on the European meat industry reveals that the per capita meat consumption has stabilized in the last 20 years (Kanerva 2013). This static overall consumption increases the pressure on the meat processing companies to adopt more efficient production methods, e.g. automated technology. At the same time, automation offers consistent benefits for safety and hygiene of the meat processing work, providing higher process controllability and better working conditions (Wadie et al. 1995, Purnell, Caldwell 2012, Purnell, Grimsby Institute of Further and Higher Education 2013). For example, the reduction of manual handling and the more efficient tool sterilization in the clean slaughter line reduce the cross contamination between carcasses, improving the food hygiene and safety. Robot technology is widely used in manufacturing industry, when products are well-defined and properly designed. Furthermore, the high investments in automation require industries with high production volumes ensuring a reasonable payback time. Pork, poultry and lamb slaughtering are fully or partially automated, e.g. poultry lines work at high speeds, while the lamb production is partially automated (Madsen, Nielsen 2002, McMurray 2013). Nevertheless, several projects failed after trying to automate the whole beef slaughtering process (Purnell 1998, Madsen, Nielsen 2002), i.e. fully automatic slaughtering is more complex in beef and pork production, due to greater dimensions and weight of the carcasses. Particularly, manual workers typically perform ham-deboning work.

This Section focuses on the improvement of health and safety of meat processing workers through ergonomics and automation. The following study introduces a comparative and sensitive analysis of manual and semi-automatic ham-deboning systems. The aim is to investigate the effects of automation on the work system and layout, analyzing the economic and ergonomic impact of semi-automatic ham deboning lines. The comparative analysis includes a non-safety cost model for the study of non-safety cost due to accidents and injuries. The non-safety cost model is tested with a case study from an Italian ham processing company. The study of the existing meat processing plant and the work system analysis reveal critical situations posing serious risks to the workers' safety and health. The study introduces the new layout proposal for the ham production process, replacing laborious manual ham-deboning activities with automated technology.

#### 2.3.2.2 Non-safety cost model

This Section introduces the non-safety cost models for the economic evaluation of the both the manual ham-deboning system and the semi-automatic ham-deboning system. The non-safety cost model analyzes the cost of the work system,  $c_s$ , together with the cost of non-safety,  $c_n$ .

Companies quantify the value of  $c_s$  including labour costs, plus investment, power supply and maintenance costs, in case of semi-automatic ham-deboning systems. Non-safety cost  $c_n$  is due to the neglected investments in safety procedures and equipment. Despite the high cost of accidents and injuries, companies frequently neglect the cost of non-safety. Workers,

companies and community pay the consequences of non-safety work. Particularly, occupational accidents cause direct costs and indirect costs to the companies. The former include quantifiable costs due to the accident event, e.g. workers' compensation payments, medical expenses, and costs for legal services etc. The latter are frequently underestimated and include lost productivity, recruitment and training of new employees, costs associated with lower employee morale and absenteeism, etc. The following Equation (1) shows the overall non-safety cost.

$$c_n = (c_d + c_i) \cdot n \quad (1)$$

Given  $n$  as the number of injuries in the reference time period,  $c_d$  as the unit direct non-safety cost and  $c_i$  as the unit indirect non-safety cost,  $c_n$  is the overall non-safety cost. Studies show that the ratio of indirect costs to direct costs,  $k$ , varies widely, from a high of 20:1 to a low of 1:1. The less serious the injury, the higher the ratio of indirect costs to direct costs (Business Roundtable 1982). As a consequence, the value of  $k$  is related to the type of injury,  $j$ . Furthermore, statistics show the incidence rate of injuries as equal to  $h$  events every 100 meat-processing workers. The following Equation (2) introduces the final formulation for the overall non-safety cost.

$$c_n = \frac{h}{100} \cdot t \cdot \sum_{j=1}^J [w_j \cdot c_{d,j} \cdot (1 + k_j)] \quad (2)$$

Given the number of worker  $w_i$  exposed to the risk of injury  $j$ , the overall  $c_n$  in the reference time period  $t$  is as in the Equation (2). The following Section 2.3.2.3 introduces the overview of the Italian Region Emilia Romagna meat industry, together with the detailed description of the reference ham production plant and the ergonomic risk assessment among deboning line workers.

### 2.3.2.3 Meat processing industry in Emilia Romagna, Italy

The pork and beef slaughterhouse and processing industries play an important role in the economy of the Emilia Romagna Region (Regione Emilia Romagna 2014). The Local Occupational Health and Safety Agency (AUSL) reports that meat processing is one of the most hazardous industries in the Emilia Romagna Region. Meat and poultry workers sustain a range of injuries, including hernia and repetitive stress injuries. According to the American Bureau of Labor Statistics, injuries in the American meat industry declined from 29.5 per 100 full-time workers in 1992 to 14.7 in 2001, but the rate was among the highest of any industry (United States Government Accountability Office 2005). Nevertheless, Italian statistics show higher incidence rates, reporting 24 injuries per 100 meat-processing workers (ASL Mantova, USL Modena 2000).

Meat processing work typically requires manual workers to keep up with the high speed of processing lines. For example, ham-deboning workers employ 50 seconds to debone one ham. Employment policies and practices of this industry result in serious physical and mental harm to meat processing workers, preventing them from reporting injuries or drawing

attention to unsafe working conditions. Furthermore, several workers are recent immigrants and face additional economic and social pressures increasing their vulnerability in the workplace (Monforton 2013). As a consequence, the meat processing is one of the most hazardous industries, as it poses a serious risk to workers' safety and health.

### 2.3.2.4 Reference meat processing plant

The meat processing plant of this study is from an Italian company situated in the Emilia Romagna Region. Figure 2.51 shows the ham processing steps in the reference meat processing plant, highlighting the hazardous manual handling activities. About twenty tractor trailers a day reach the plant, where manual workers unload the hams with a 1,800 hams per hour pace. Two different lines typically move the pork legs towards different processes. The first line is for the ham salting before the aging process and it is conventionally called "salt line". The latter is the "deboning line" and it moves the pieces towards the speck and ham steak production processes. The hams processed in the salt line are delivered to further processing plant for the aging process, whilst ready-to-eat specks and hams are packed as whole pieces or sliced packs, then delivered all over the world. Salt line workers trim about 1,300 hams per hour, whilst manual deboning line workers prepare about 375 hams per hour. Particularly, the hams for the deboning line are manually arranged on specific hanging racks and moved towards the processing phases.

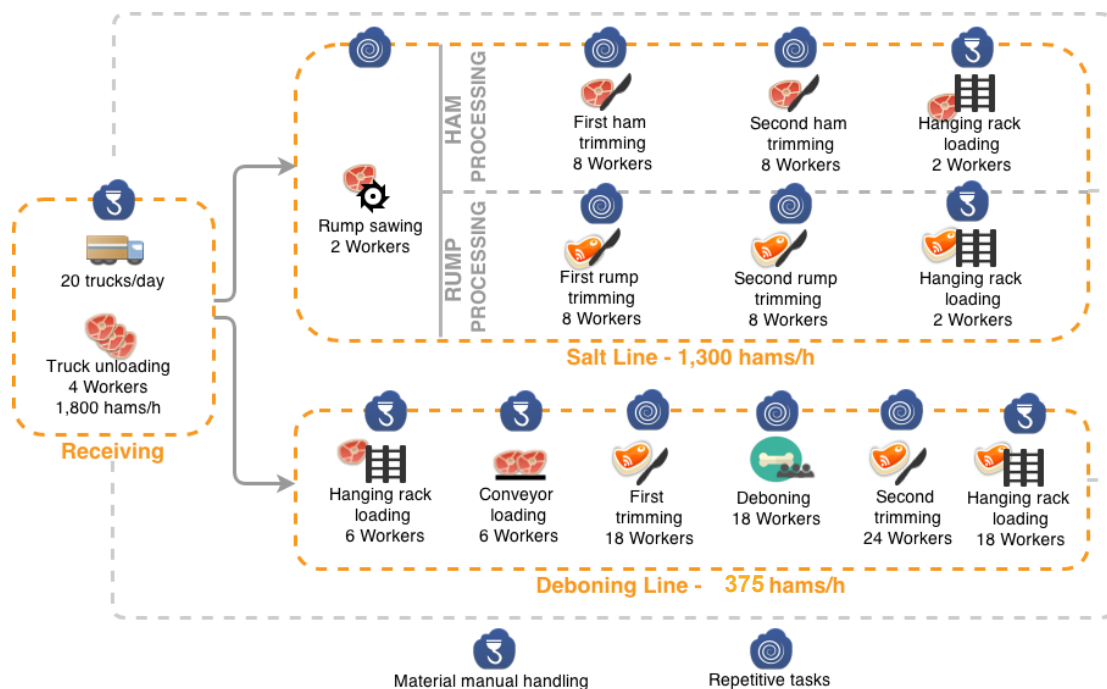

Figure 2.51 Ham flow in the reference meat processing plant.

The daily work shift is of eight hours a day for each worker, while the plant runs two eight-hour shifts.

### 2.3.2.5 Working conditions

Hanging rack and conveyor loading, as well as trimming and deboning work, are high-intensive activities. The former require high force due to the Manual Material Handling (MMH), while the latter involve repetitive motions (R) of the upper-limbs, mainly concerning the hands, the wrists, the shoulders, but even the neck and the trunk. The International (ISO 11228-1 2003) standard deals with MMH and is based on the 1991 NIOSH Lifting Equation (Waters, Putz-Anderson & Garg 1994). The NIOSH Lifting Equation is a method to assess the ergonomic risk of in activities with repeated lifting. The Equation recommends a weight limit for lifting activities, defining the NIOSH Lifting Index as the ratio of the actual load weight to the recommended weight limit. The OCRA Check-list is the risk assessment method for the ergonomic risk assessment of upper limbs (ISO 11228-3 2007). Such tool is used for the initial screening of the exposure to biomechanical overload of the upper limbs associated with manual R. The OCRA Checklist uses an analysis system based on pre-assigned numerical values for critical risk factors, e.g. lack of recovery time, movement frequency and force. Table 1 shows the results of the ergonomic risk assessment through OCRA Check-list for repetitive tasks and NIOSH method for MMH, of six deboning line workers (Occhipinti 1998, ISO 11228-1 2003, ISO 11228-3 2007). The OCRA Check-list and NIOSH Lifting Index (LI) values in Table 2.7 are comparable with the ergonomic risk assessment scores for all the workers at each workstation of the reference deboning line.

Table 2.32 Ergonomic risk assessment scores for manual deboning line workers

Worker	Activity	Risk	OCRA Check-list	NIOSH LI	Workers performing the same activity [workers]
1	Rack loading	MMH	-	2.44	6
2	Conveyor loading	MMH	-	2.44	6
3	First trimming	R	13.5	-	18
4	Deboning	R	29.1	-	18
5	Second trimming	R	11.5	-	24
6	Rack loading	MMH	-	1.75	18

The OCRA Check-list values in Table 2.7 refer to the most stressed arm, for each worker. The threshold limit value for acceptable risk is 7.5. High OCRA Check-list values (greater than or equal to 22.6) characterize high-risk repetitive tasks (Occhipinti 1998, ISO 11228-3 2007), i.e. deboning activities pose high threat to the health and safety of workers. The NIOSH LI threshold limit value for acceptable risk of MMH is 1 (ISO 11228-1 2003), i.e. hanging rack and conveyor loading pose serious threat to the health and safety of deboning line workers (see in Table 1). Both MMH and Repetitive tasks (R) are performed in harsh working conditions, due to cold climate and spatially restricted working environment. Furthermore, workers are forced to keep up with the speed of processing lines, at overcrowded workstations in uncomfortable conditions. The analysis of the reference manual deboning line highlights high-risk situations, posing a direct threat to workers' safety and health.

### 2.3.2.6 Semi-automatic deboning system

This Section outlines the new ham flow proposal and the feasibility analysis, after the introduction of an ham-deboning machine for deboning activities.

The proposed pork ham automatic deboning system is the Mayekawa HAMDAS-R in Figure 2.52. The deboning process is outlined in the following Figure 2.53. This leg deboning machine performs the automatic deboning of 500 hams per hour. After auto-loading pig's thigh deboned hipbone, the ham-deboning machine detects right and left legs. As in Figure 2.53, the system includes the whole bone length measuring function that enables to react the difference between calf bone and thighbone.



Figure 2.52 Mayekawa HAMDAS-R ([www.mayekawa.com](http://www.mayekawa.com)).

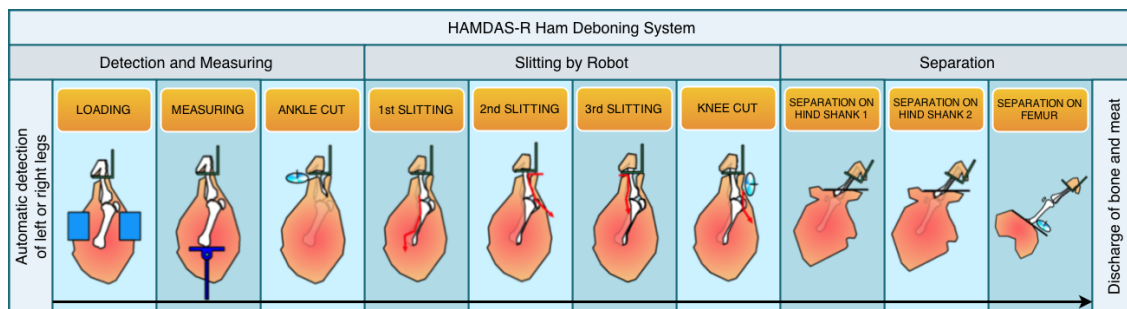

Figure 2.53 Mayekawa HAMDAS-R ham-deboning process.

The vertical multi-joint robot cuts meat along the bone. Deboned hams and bones are the process outputs (see in Figure 2.53). The system ensures high deboning performances, i.e. the average meat loss on the bones is 60g. The meat weight loss after the semi-automatic deboning process is minimum, as the hams move through a limited number of manual workstations. The machine specifications are in the following Table 2.7.



Table 2.33 Mayekawa HAMDAS-R specifications

Capacity	Maximum 500 legs/hour with 3 pre-cut machines Maximum 170 legs/hour with 1 pre-cut machines
Dimensions	W137.8"xL429.1"xH118.1" with 3 pre-cut machine W137.8"xL307.8"xH118.1" with 1 pre-cut machine
Electricity supply	AC 3 phases, 240 V – 50 kW
Air supply	2,400 l/ min dry air at 7-12 barG Dew point 5°C at 5barG
Water supply	60°C, 2-3 barG-10 l/min
Weight	Approximately 13,500 kg

The ham-deboning machine requires conventional electricity and air supply to work. Water supply is necessary for cleaning operations, while no additional groundwork is necessary for the installation on conventional industrial floors.

The new layout proposal includes the semi-automatic ham-deboning machine. The semi-automatic deboning line proposal is in the following Figure 2.54.

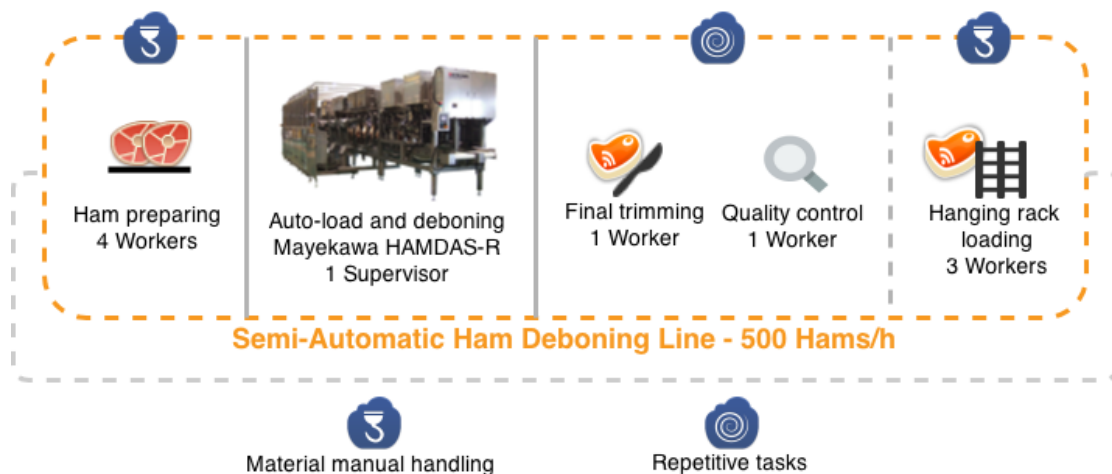

Figure 2.54 Semi-automatic deboning line proposal with the Mayekawa HAMDAS-R ham-deboning machine.

Truck-unloading workers manually lay down the hams on the conveyor, as in the traditional process (see in Figure 2.51 and Figure 2.54). The robot auto-loads and detects right or left legs, replacing the pre-deboning manual material handling activities. The vertical multi-joint robot starts the deboning process and cuts meat along the bone. After the automatic deboning, the ham is free from the damages caused by knife and ready for further trimming operations. The new layout proposal in Figure 2.54 is not fully automated. The ham-deboning machine requires seven workers to prepare the hams and supervise the deboning process. Particularly, four workers prepare the hams before the cutting phase, while two workers check the quality of deboned hams and perform final trimming operations. Finally, one worker supervises up to three working machines.

### 2.3.2.7 Manual ham-deboning process versus semi-automatic ham-deboning system

The following analysis outlines the comparative analysis of the semi-automatic deboning system proposal. Table 2.8 outlines the comparison of the manual ham-deboning process and the semi-automatic ham-deboning system. Considering the ham flow data of the reference meat processing plant in Figure 2.51, six ham-deboning machines are necessary to guarantee the daily demand of deboned products. The semi-automatic deboning system allows several workers to perform safer operations than manual material handling and repetitive tasks of the reference manual ham-deboning process, e.g. machine supervision and deboned ham quality check.

Table 2.34 Comparison of manual ham-deboning process versus semi-automatic ham-deboning system

Variable	Manual process	Semi-automatic system
Daily demand of deboned hams [products]	3,000	3,000
Number of automatic machines [machines]	0	6
Number of workers required per shift [workers]	90	56
Manual workers per shift [workers]	90	54
Workers performing MMH per shift [workers]	30	42
Workers performing R per shift [workers]	60	12

As a consequence, the overall number of workers exposed to the risk of manual handling is lower for the semi-automatic system (see in Table 2.8). The overall number of manual material handling workers is higher in the semi-automatic system proposal since twenty-four workers prepare the hams for the auto-load robots. Furthermore, the ham-deboning machine performs strenuous repetitive tasks, which were previously required to manual workers. The following Table 2.9 shows the ergonomic risk assessment scores of five deboning line workers at the semi-automatic deboning line.

Table 2.35 Ergonomic risk assessment scores for workers at the semi-automatic deboning line

Worker	Activity	Risk	OCRA Check-list	NIOSH LI	Workers performing the same activity [workers]
1	Ham preparing	MMH	-	1.21	24
2	Supervising	-	-	-	2
3	Trimming	R	11.5	-	6
4	Quality control	R	7.5	-	6
5	Rack loading	MMH	-	1.75	18

Particularly, trimming and quality control workers perform both the tasks at the same workstation. The OCRA Check-list and NIOSH Lifting Index (LI) values in Table 2.9 are comparable with the ergonomic risk assessment scores for all the workers at each workstation of the semi-automatic deboning line. The OCRA Check-list mean value reduction is 45%. The new layout proposal involves autonomous robots lifting the hams, while workers

prepare the pork legs on the conveyor (see in Figure 2.54). As Table 2.6 and Table 2.9 show, preparing activity is less intensive than hanging rack loading or conveyor loading, i.e. the NIOSH LI reduction is 29%. Supervising and quality control tasks do not expose workers to ergonomic risk of manual handling, while trimming and hanging rack loading are high-intensive activities, as in the reference manual system (see in Table 2.9). The semi-automatic ham-deboning system requires 80% less manual workers performing R, compared with the reference ham-deboning process.

### 2.3.2.8 Comparative and sensitive analysis

The following comparative analysis aims to compare the reference ham-deboning system and the semi-automatic ham-deboning proposal. The analysis investigates the impact of non-safety cost on the hourly cost of the ham-deboning system. The cost analysis of the semi-automatic system includes fixed and variable costs, due to adoption of the semi-automatic machines. The fixed investment cost is based on a 10-year life, 4% of interest rate, and 3,520 hours of work per year and machine. Variable costs include labor, energy and maintenance costs. Particularly, maintenance costs are due to the cutting tool replacement, e.g. blades and knives, and no additional maintenance is required. The comparative analysis includes the non-safety cost model for the non-safety cost analysis. The Occupational Safety and Health Agency's (OSHAa) Safety Pays Program estimates the values of  $c_d$  and  $k$  for occupational injuries. The following analysis includes the values of  $c_d$  and  $k$  for injuries related to MMH and R. Particularly, hernia injury is associated with MMH, while common R injury is carpal tunnel syndrome. The OSHA estimates the average  $c_d$  of hernia injury as equal to 22,548 \$, the average  $c_d$  of carpal tunnel syndrome as equal to 30,000 \$ and  $k$  as equal to 1.1 for both such injuries. The value of  $n$  depends on the number of accidents occurred in the reference time period. Statistics show the incidence rate as equal to 24 accidents every 100 meat-processing workers (ASL Mantova, USL Modena 2000). As a consequence, the expected number of accidents in the reference time period is 435 for the manual ham-deboning system and 271 for the semi-automatic system. The following Table 2.10 shows the impact of the non-safety costs on the results of the comparative and sensitive analysis.

Table 2.36 Comparative and sensitive analysis

Variable	S1	S2	S3
Productive capacity [hams/day]	3,000	500	5,000
Accidents with the manual ham-deboning system [accidents]	436	53	750
Accidents with the semi-automatic ham-deboning system [accidents]	271	48	455
Non-safety cost of the manual ham-deboning system [k€]	19,907.48 k€	2,433.14k€	34,285.10 k€
Non-safety cost of the semi-automatic ham-deboning system [k€]	10,895.91 k€	1,945.70 k€	18,289.56 k€
Non-safety cost saving [k€]	9,011.57 k€	487.44 k€	15,995.53 k€
Hourly cost saving [%]*	+22.98 %	-6.42 %	+28.20 %

The three Scenarios in Table 2.10 show the non-safety cost analysis and the impact of non-safety cost on the hourly cost of the ham-deboning system. The hourly cost saving is shown as percentage because of the company's request to cover the actual hourly cost of the ham-deboning systems. Scenario 1 shows the comparative analysis of the reference case study. The semi-automatic ham-deboning system in Scenario 1 leads to 9,011.57 k€ non-safety cost saving. The hourly cost of the semi-automatic ham-deboning system is lower than the hourly cost of the manual ham-deboning system, i.e. the percentage hourly cost saving is +22.98% (see in Table 2.10). Scenario 2 and Scenario 3 show the non-safety cost analysis varying production capacity and dimensions of the ham-deboning system. Scenario 2 reflects a small-sized meat-processing company with 500 hams/day production capacity, while Scenario 3 reflects a large meat-processing company with 5,000 hams/day production capacity (see in Table 2.10). The hourly cost of the manual system is lower than the hourly cost of the semi-automatic system, in Scenario 2. Conversely, Scenario 3 shows high non-safety cost saving due to the semi-automatic system, when companies' production capacity is high. The larger the company dimension, the higher the impact of non-safety cost saving and the hourly cost saving with the semi-automatic ham-deboning system (see in Table 2.10).

#### 2.3.2.9 Discussion

The semi-automatic ham-deboning proposal includes the adoption of automated technology, replacing manual workers for high-risk ham-deboning activities. The comparative and sensitive analysis in Section 2.3.2.8 shows the impact of non-safety cost on the hourly cost of the ham-deboning system. Three Scenarios describe the non-safety cost of the system, varying production capacity and dimensions of the ham-deboning system. Results show the positive impact of the semi-automatic ham-deboning system on workers' ergonomics and on the company's profitability. The new layout proposal leads to lower hourly cost of the ham-deboning system, compared with the reference ham-deboning system (see Scenario 1 in Table 2.10). The comparative and sensitive analysis shows the impact of non-safety cost, varying production capacity and dimensions of the ham-deboning system. Results show that the larger the company dimension, the higher the non-safety cost saving and the hourly cost saving with the semi-automatic ham-deboning system (see in Table 2.10). Despite the initial investment for the machines purchase, the semi-automatic system ensures both short- and long-term benefits for workers, employers and customers. Furthermore, the ham-deboning machine accomplishes high-risk cutting and handling activities, while workers perform safer operations, e.g. machine supervision and deboned ham quality check. The following Figure 2.27 shows the results of the comparative analysis from the ergonomic perspective.

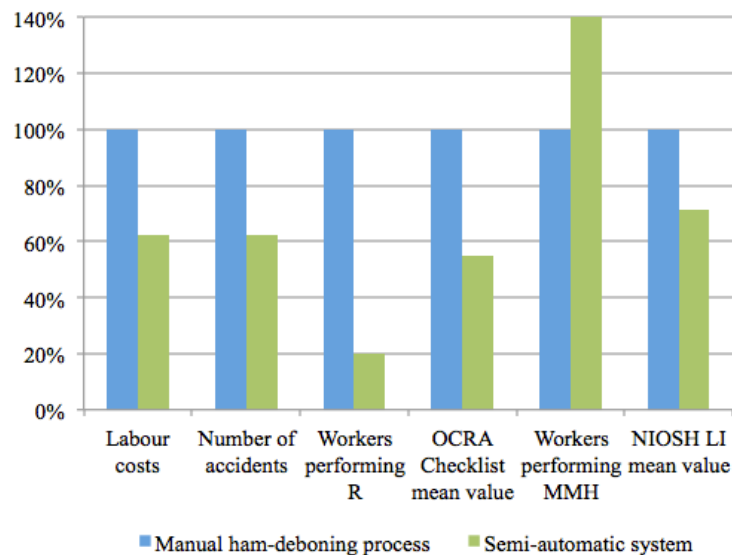

Figure 2.55 Ergonomic risk assessment results comparison

The semi-automatic ham-deboning system requires less manual workers than the manual ham-deboning process (Figure 2.55). Labor costs and direct non-safety costs are lower, i.e. automation drastically reduces the need for MMH and R workers, leading to a significant decrease in injury and accident rates. Figure 2.55 shows the ergonomic effects of the manual ham-deboning process and the semi-automatic ham-deboning system on the workers' health and safety. Particularly, the semi-automatic ham-deboning system requires 80% less manual workers performing R, compared with the reference ham-deboning process. The OCRA Check-list mean value reduction (45%) in Table 2.9 confirms the reduction of the exposure to R of the upper limbs, with the semi-automatic ham-deboning system. The ergonomic risk assessments results for workers performing MMH show safer working conditions with the semi-automatic ham-deboning system. Despite the higher number of workers performing MMH, the NIOSH LI mean value reduction (29%) with the semi-automatic ham-deboning system is dramatic. The robot technology further ensures high quality of the final products. As a result, the final product is standard-sized and devoid of cutting damages due to knives and blades. Furthermore, product hygiene and security improve as well, as the contact with human hands is drastically reduced.

#### 2.3.2.10 Conclusions and considerations on the integration of automation in the manual ham-deboning process

Work activities in the meat processing industry are both technically and physically demanding. The ergonomic risk assessment among deboning workers of an Italian ham processing company confirms high ergonomic risk due to manual handling tasks. The reference manual ham-deboning line is introduced, together with the semi-automatic system proposal. The semi-automatic deboning system includes the adoption of automated technology, replacing manual workers for high-risk manual activities, e.g. manual material handling of heavy pork legs and repetitive deboning tasks. The comparative and sensitive

analysis shows the impact of non-safety cost on the hourly cost of the ham-deboning system. The non-safety cost analysis reveals the positive impact of the semi-automatic ham-deboning system on the company's profitability. Particularly, results show that the new layout proposal leads to lower hourly cost of the semi-automatic ham-deboning line. Furthermore, automated technology improves the product quality, hygiene and security, leading to economic and ergonomic benefits for workers, employers and customers. Future developments of this study include the analysis of further layout re-design proposals, aiming to support manual workers through automation and improving ergonomics in the meat processing industry.

## 2.4 REFERENCES

- Adler, P.S., Goldoftas, B. & Levine, D.I. 1997, "Ergonomics, employee involvement, and the Toyota Production System: a case study of NUMMI's 1993 model introduction.", *Industrial and Labor Relations Review*, vol. 50, no. 3, pp. 416-437.
- Al Zuheri, A., Luong, L. & Xing, K. 2014, "Developing a multi-objective genetic optimisation approach for an operational design of a manual mixed-model assembly line with walking workers", *Journal of Intelligent Manufacturing*, pp. 1-17.
- Alber, M., Yarali, O., Dahl, F., Bruland, A., Kasling, H., Michalakopoulos, T.N., Cardu, M., Hagan, P., Aydin, H. & Ozarslan, A. 2014, "ISRM Suggested Method for Determining the Abrasivity of Rock by the CERCHAR Abrasivity Test", *Rock Mechanics and Rock Engineering*, vol. 47, no. 1, pp. 261-266.
- AL-Marakeby, A., Aly, A.A. & Salem, F.A. 2013, "Fast Quality Inspection of Food Products using Computer Vision," *International Journal of Advanced Research in Computer and Communication Engineering*, vol. 2, no. 11, pp. 4168-4171.
- Aniello, M. 2016, *Soft tissue injuries in construction*, The Associated General Contractors of America, AGC California.
- Aptel, M., Cail, F., Gerling, A. & Louis, O. 2008, "Proposal of parameters to implement a workstation rotation system to protect against MSDs", *International Journal of Industrial Ergonomics*, vol. 38, no. 11–12, pp. 900-909.
- Aqlan, F., Lam, S., Ramakrishnan, S. & Boldrin, W. 2014, "Integrating Lean and Ergonomics to Improve Internal Transportation in a Manufacturing Environment", *Proceedings of the 2014 Industrial and Systems Engineering Research Conference*
- Aroca, R.V., Gomes, R.B., Dantas, R.R., Calbo, A.G. & Gonçalves, L.M.G. 2013, "A wearable mobile sensor platform to assist fruit grading" *Sensors*, vol. 13, no. Switzerland, pp. 6109.
- Asensio-Cuesta, S., Diego-Mas, J., Cremades-Oliver, L. & González-Cruz, M.C. 2012, "A method to design job rotation schedules to prevent work-related musculoskeletal disorders in repetitive work", *International Journal of Production Research*, vol. 50, no. 24, pp. 7467-7478.
- ASL Mantova & USL Modena 2000, *I profili di rischio nella macellazione: identificazione e misura degli effetti*, Servizi di Medicina Preventiva e Igiene del Lavoro.

- Attaianese, E. & Duca, G. 2008, *Manuale di raccomandazioni ergonomiche per le postazioni di lavoro metalmeccaniche INAIL*, Direzione Regionale della Campania - Fridericiana Editrice Universitaria.
- Azizi, N., Zolfaghari, S. & Liang, M. 2010, "Modeling job rotation in manufacturing systems: The study of employee's boredom and skill variations", *International Journal of Production Economics*, vol. 123, no. 1, pp. 69-85.
- Balaguer, C. & Abderrahim, M. 2008, in *Robotics and Automation in Construction*, ed. Carlos Balaguer and Mohamed Abderrahim (Ed.), InTech edn, Available from: [http://www.intechopen.com/books/robotics\\_and\\_automation\\_in\\_construction/trends\\_in\\_robotics\\_and\\_automation\\_in\\_construction](http://www.intechopen.com/books/robotics_and_automation_in_construction/trends_in_robotics_and_automation_in_construction).
- Bao, S., Winkel, J., Mathiassen, S.E. & Shahnava, H. 1997, "Interactive effect of ergonomics and production engineering on shoulder-neck exposure — A case study of assembly work in China and Sweden", *International Journal of Industrial Ergonomics*, vol. 20, no. 1, pp. 75-85.
- Barbosa, G.F., Carvalho, J. & Filho, E.V.G. 2014, "A proper framework for design of aircraft production system based on lean manufacturing principles focusing to automated processes", *International Journal of Advanced Manufacturing Technology*, vol. 72, no. 9-12, pp. 1257-1273.
- Barbut, S. 2014, "Review: Automation and meat quality-global challenges", *Meat Science*, vol. 96, no. 1, pp. 335-345.
- Basher, A., Nath, P., Siddique, Z.S., Rahman, M.H., Rubel, M.A., Sayed, M.S., Ahmad, S.A., Mondol, G.D. & Bhuiyan, M.R. 2015, "Musculoskeletal disorder (MSD) among agricultural workers," *Mymensingh medical journal: MMJ*, vol. 24, no. 1, pp. 1-8.
- Belforte, G., Deboli, R., Gay, P., Piccarolo, P. & Ricauda Aimonino, D. 2006, "Robot Design and Testing for Greenhouse Applications," *Biosystems Engineering*, vol. 95, no. 3, pp. 309-321.
- Berggren, C., Bjorkman, T. & Hollander, E. (eds) 1991, *Are They Unbeatable? Report from a Field Trip to Study Transplants, the Japanese Owned Auto Plants in North America*, Royal Institute of Technology, Stockholm, Sweden.
- Bernold, L.E., Altobelli, F.R. & Taylor, H. 1992, "Computer-Controlled Brick Masonry," *Journal of Computing in Civil Engineering*, vol. 6, no. 2, pp. 147-160.



- Bley, H., Reinhart, G., Seliger, G., Bernardi, M. & Korne, T. 2004, "Appropriate Human Involvement in Assembly and Disassembly", *CIRP Annals - Manufacturing Technology*, vol. 53, no. 2, pp. 487-509.
- Boenzi, F., Digiesi, S., Mossa, G., Mummolo, G. & Romano, V.A. 2013, "Optimal break and job rotation schedules of high repetitive - Low load manual tasks in assembly lines: An OCRA - Based approach", *IFAC proceedings volumes*, no. IFAC-PapersOnline, pp. 1896.
- Bogue, R. 2008, "Cutting robots: a review of technologies and applications," *Industrial Robot*, vol. 35, no. 5, pp. 390-396.
- Botti, L., Gamberi, M., Manzini, R., Mora, C. & Regattieri, A. 2014, "A bi-objective optimization model for work activity scheduling of workers exposed to ergonomic risk", *Proceedings of the XIX Summer School "Francesco Turco"*.
- Botti, L., Mora, C. & Regattieri, A. 2015, "Improving Ergonomics in the Meat Industry: A Case Study of an Italian Ham Processing Company", *IFAC Symposium on Information Control in Manufacturing INCOM 2015*, pp. 598.
- Bowler, M. & Kurfess, T. 2010, "Retrofitting lean manufacturing to current semi-automated production lines", *International Conference on Advances in Production Management Systems, APMS 2010, October 11, 2010 - October 13* Poliprint - Politecnico di Milano, Cernobbio, Como, Italy, 2010, pp. *Ingenierie des Organisations Distribuees (IODE); GDR Macs*.
- Brandon, B.D., Cerkovnik, J., Koskie, E., Bayoud, B.B., Colston, F., Clayton, R.I., Anderson, M.E., Hollister, K.T., Senger, J. & Niemi, R. 1992, "First Revision to the IADC Fixed Cutter Dull Grading System", *SPE/IADC Drilling Conference*.
- Brenner, M.D., Fairris, D. & Ruser, J. 2004, "Flexible work practices and occupational safety and health: exploring the relationship between cumulative trauma disorders and workplace transformation", *Industrial Relations: A Journal of Economy and Society*, vol. 43, no. 1, pp. 242-266.
- BS OHSAS 18001 2007, *Occupational health and safety management systems. Requirements*.
- Burdorf, A., Windhorst, J., van der Beek, A.J., van der Molen, H. & Swuste, P.H.J.J. 2007, "The effects of mechanised equipment on physical load among road workers and floor layers in the construction industry," *International Journal of Industrial Ergonomics*, vol. 37, no. 2, pp. 133-143.

- Business Roundtable 1982, *Improving Construction Safety Performance: A Construction Industry Cost Effectiveness Project Report*, New York, NY.
- Carnahan, B J Redfern, M S Norman, B. 2000, "Designing safe job rotation schedules using optimization and heuristic search", *Ergonomics*, vol. 43, no. 4, pp. 543.
- Clarke, R., Nielsen, J.U. & Madsen, N.T. 2014, "Automation in the meat industry. Cutting and Boning" in *Encyclopedia of Meat Sciences (Second Edition)*, eds. M. Dikeman & C. Devine, Academic Press, Oxford, pp. 33-42.
- Collins, J.W., Nelson, A. & Sublet, V. 2006, *Safe Lifting and Movement of Nursing Home Residents*, Department of Health and Human Services DHHS (NIOSH), Cincinnati, Ohio.
- Conti, R., Angelis, J., Cooper, C., Faragher, B. & Gill, C. 2006, "The effects of just in time/ lean production on worker job stress.", *International Journal of Operations and Production Management*, vol. 26, no. 9, pp. 1013-1038.
- Corominas, A., Lusa, A. & Pastor, R. 2004, "Characteristics and classification of the annualised working hours planning problems", *International Journal of Services Technology and Management*, vol. 5, no. 5-6, pp. 435-447.
- Correal, R., Jardón, A., Martínez, S., Cabás, R., Giménez, A. & Balaguer, C. 2006, *Human-robot coexistence in robot-aided apartment*.
- Courtney, T.K., Matz, S. & Webster, B.S. 2002, "Disabling occupational injury in the US construction industry, 1996," *Journal of occupational and environmental medicine / American College of Occupational and Environmental Medicine*, vol. 44, no. 12, pp. 1161-1168.
- Coury, H.J.C.G., Alfredo Léo, J. & Kumar, S. 2000, "Effects of progressive levels of industrial automation on force and repetitive movements of the wrist", *International Journal of Industrial Ergonomics*, vol. 25, no. 6, pp. 587-595.
- Cubero, S., Aleixos, N., Albert, F., Torregrosa, A., Ortiz, C., García Navarrete, O. & Blasco, J. 2014a, "Optimised computer vision system for automatic pre-grading of citrus fruit in the field using a mobile platform," *Precision agriculture*, vol. 15, no. 1, pp. 80.
- Cubero, S., Diago, M.P., Blasco, J., Tardáguila, J., Millán, B. & Aleixos, N. 2014b, "A new method for pedicel/peduncle detection and size assessment of grapevine berries and other fruits by image analysis," *Biosystems engineering*, vol. 117, no. C, pp. 62.

- Datalogic a, *Jade X7*. Available: <http://www.datalogic.com/eng/products/automatic-data-capture/in-counter/on-counter-scanners/scales/jade-x7-pd-615.html> [2016, July, 30].
- Datalogic b, *The Joya device*. Available: <http://www.joya.datalogic.com> [2016, July, 11].
- De-An, Z., Lv, J., Ji, W., Zhang, Y. & Chen, Y. 2011, *Design and control of an apple harvesting robot*.
- Deming, W.E. 1986, *Out of the Crisis*, Massachusetts Institute of Technology, Center for Advanced Engineering Study, Cambridge, MA.
- De Treville, S. & Antonakis, J. 2006, "Could lean production job design be intrinsically motivating? Contextual, configurational, and levels-of-analysis issues", *Journal of Operations Management*, vol. 24, no. 2, pp. 99-123.
- Deshmukh, S.V. & Patil, S.G. 2012, "Influence on physical work while working with segmental vibration inducing hand operated power tools ", *International Journal of Engineering and Technology (IJET)*, vol. 4, no. 5, pp. 308-323.
- Dhivya, A., Infanta, J. & Chakrapani, K. 2012, "Automated agricultural process using PLC and ZigBee," *Journal of Artificial Intelligence*, vol. 5, no. 4, pp. 170-177.
- Dickerson, S., Coleman, S., McMurray, G.V., Holcombe, W. & Prince, J. 2005, *The commercialization of a low-cost, high-speed pick-and-place casepacker*, World's Poultry Science Association (WPSA), Beekbergen.
- Diego-Mas, J.A., Asensio-Cuesta, S., Sanchez-Romero, M.A. & Artacho-Ramirez, M.A. 2009, "A multi-criteria genetic algorithm for the generation of job rotation schedules", *International Journal of Industrial Ergonomics*, vol. 39, no. 1, pp. 23-33
- Dong, R.G., Rakheja, S., McDowell, T.W., Welcome, D.E. & Wu, J.Z. 2010, "Estimation of the biodynamic responses distributed at fingers and palm based on the total response of the hand–arm system", *International Journal of Industrial Ergonomics*, vol. 40, no. 4, pp. 425-436.
- Dong, R.G., Wu, J.Z. & Welcome, D.E. 2005, "Recent Advances in Biodynamics of Human Hand-Arm System", *Ind Health*, vol. 43, no. 3, pp. 449-471.
- Draicchio, F., Trebbi, M., Mari, S., Forzano, F., Serrao, M., Sicklinger, A., Silveti, A., Iavicoli, S. & Ranavolo, A. 2012, "Biomechanical evaluation of supermarket cashiers before and after a redesign of the checkout counter," *Ergonomics*, vol. 55, no. 6, pp. 650.
- Dul, J. & Neumann, W.P. 2009, "Ergonomics contributions to company strategies," *Applied Ergonomics*, vol. 40, no. 4, pp. 745-752.

- Dul, J., de Vries, H., Verschoof, S., Eveleens, W. & Feilzer, A. 2004, "Combining economic and social goals in the design of production systems by using ergonomics standards", *Computers & Industrial Engineering*, vol. 47, no. 2–3, pp. 207-222.
- EN 1005-2 2003, *Safety of machinery. Human physical performance. Manual handling of machinery and component parts of machinery*.
- Ersoy, A. & Waller, M.D. 1995, "Wear characteristics of PDC pin and hybrid core bits in rock drilling", *Wear*, vol. 188, no. 1–2, pp. 150-165.
- EU-OSHA 2007, *E-fact 12 - Work related musculoskeletal disorders in the service and retail sectors*, European Agency for Safety and Health at Work.
- EU-OSHA 2008, *Musculoskeletal disorders (MSDs) in HORECA*.
- Faucett, J., Kang, T. & Newcomer, R. 2013, "Personal service assistance: Musculoskeletal disorders and injuries in consumer-directed home care," *American Journal of Industrial Medicine*, vol. 56, no. 4, pp. 454-468.
- Feng, Q.C., Wang, X., Zheng, W.G., Qiu, Q. & Jiang, K. 2012, "New strawberry harvesting robot for elevated-trough culture., 2012; 5(2): 1," *International Journal Agricultural & Biological Engineering*, vol. 5, no. 2, pp. 1-8.
- Feng, G. & Qixin, C. 2004, "Study on color image processing based intelligent fruit sorting system," *Fifth World Congress on Intelligent Control and Automation, 2004. WCICA 2004.*, pp. 4802.
- Flegner, P. 2016, "Significant damages of core diamond bits in the process of rocks drilling", *Engineering Failure Analysis*, vol. 59, pp. 354-365.
- Foglia, M.M. & Reina, G. 2006, "Agricultural robot for radicchio harvesting," *Journal of Field Robotics*, vol. 23, no. 6-7, pp. 363-377.
- Fonseca, H., Loureiro, I.F. & Arezes, P. 2013, "Development of a job rotation scheme to reduce musculoskeletal disorders: A case study" in *Occupational Safety and Hygiene*, ed. G. Perestrelo, CRC Press, pp. 351-356.
- Font, D., Tresanchez, M., Pallejà, T., Teixidó, M., Martinez, D., Moreno, J. & Palacín, J. 2014, "An image processing method for in-line nectarine variety verification based on the comparison of skin feature histogram vectors," *Computers and Electronics in Agriculture*, vol. 102, pp. 112.
- Galinsky, T., Waters, T. & Malit, B. 2001, "Overexertion Injuries in Home Health Care Workers and the Need for Ergonomics," *Home health care services quarterly*, vol. 20, no. 3, pp. 57-73.

- Gambao, E., Balaguer, C., Barrientos, A., Saltaren, R. & Puente, E.A. 1997, "Robot assembly system for the construction process automation," *IEEE International Conference on Robotics and Automation, 1997*, pp. 46.
- Gambao, E., Hernando, M. & Surdilovic, D. 2008, "Development of a Semi-automatic Cost-Effective Facade Cleaning System," *International Association of Automation and Robotics in Construction (IAARC), 27/06/2008-29/06/2008*.
- Gemne, G. & Taylor, W. 1983, "Foreword: Hand-arm vibration and the central automatic nervous system.", *Journal of Low Frequency Noise and Vibration*, vol. Special Volume, pp. 1-12.
- Gil, M.S., Kang, M.S., Lee, S.H., Kim, D., Kim, B.K. & Han, C.S. 2011, "Proposal of installation method of heavy duty glass using intuitive manipulation device" in *Proceedings of the 28th International Symposium on Automation and Robotics in Construction, ISARC 2011*, pp. 82-88.
- Griffin, M. 1990, *Handbook of human vibration*. Academic Press, London.
- Guo, J., De-An, Z., Ji, W. & Xia, W. 2010, "Design and control of the open apple-picking-robot manipulator," *Computer Science and Information Technology (ICCSIT), 2010 3rd IEEE International Conference on*, pp. 5.
- Hamade, R.F., Manthri, S.P., Pusavec, F., Zacny, K.A., Taylor, L.A., Dillon Jr., O.W., Rouch, K.E. & Jawahir, I.S. 2010, "Compact core drilling in basalt rock using PCD tool inserts: Wear characteristics and cutting forces", *Journal of Materials Processing Technology*, vol. 210, no. 10, pp. 1326-1339.
- Hasankhani, R. & Navid, H. 2012, "Potato Sorting Based on Size and Color in Machine Vision System," *Journal of Agricultural Science*, vol. 4, no. 5.
- Hasegawa, Y. 2006, "Construction Automation and Robotics in the 21th century," *23rd International Symposium on Robotics and Automation in Construction (ISARC'06)*.
- Hassankhani, R., Navid, H. & Seyedarabi, H. 2012, "Potato surface defect detection in machine vision system," *African Journal of Agricultural Research*, vol. 7, no. 5, pp. 844-850.
- Hayashi, S., Shigematsu, K., Yamamoto, S., Kobayashi, K., Kohno, Y., Kamata, J. & Kurita, M. 2010, "Research Paper. Evaluation of a strawberry-harvesting robot in a field test," *Biosystems Engineering*, vol. 105, no. 2, pp. 160-171.

- Hedelind, M. & Jackson, M. 2011, "How to improve the use of industrial robots in lean manufacturing systems", *Journal of Manufacturing Technology Management*, vol. 22, no. 7, pp. 891-905.
- Hough Jr., O.L. & Das, B. 1985, "Wear Characteristics of Polycrystalline Diamond Compact Drill Bits in Small Diameter Rock Drilling", *Journal of Energy Resources Technology*, vol. 107, no. 4, pp. 534-542.
- HSE (ed) 2014, *Confined Spaces Regulations 1997. Approved Code of Practice, Regulations and guidance*, Third edition edn, Health and Safety Executer (HSE).
- HSE 2005, *Control of Vibration at Work Regulations 2005 (2005 No. 1093)*.
- Huete, A.J., Victores, J.G., Martínez, S., Giménez, A. & Balaguer, C. 2012, "Personal autonomy rehabilitation in home environments by a portable assistive robot," *IEEE Transactions on Systems, Man, and Cybernetics, Part C: Applications and Reviews*, vol. 42, no. 4, pp. 561.
- ISO 5349-1 2001, *Mechanical vibration. Measurement and evaluation of human exposure to hand-transmitted vibration. Part 1: General requirements*.
- ISO 6385 "Ergonomic principles in the design of work systems," 2004.
- ISO 7250-1 2008, *Basic human body measurements for technological design. Part 1: Body measurement definitions and landmarks*.
- ISO 7250-2 2010, *Basic human body measurements for technological design. Part 2: Statistical summaries of body measurements from national populations*.
- ISO 7250-3 2015, *Basic human body measurements for technological design. Part 3: Worldwide and regional design ranges for use in ISO product standards*.
- ISO 8041 2005, *Human response to vibration. Measuring instrumentation*. ISO 9241-11 1998, *Ergonomic requirements for office work with visual display terminals (VDTs). Part 11: Guidance on usability*.
- ISO 11064-1 2000, "Ergonomic design of control centres. Part 1: Principles for the design of control centres."
- ISO 11064-2 2000, "Ergonomic design of control centres. Part 2: Principles for the arrangement of control suites."
- ISO 11064-3 1999, "Ergonomic design of control centres. Part 3: Control room layout."
- ISO 11064-4 2013, "Ergonomic design of control centres. Part 4: Layout and dimensions of workstations."

- ISO 11226 2000, *Ergonomics. Evaluation of static working postures.*
- ISO 11228-1 2003, *System of standards for labor safety. Ergonomics. Manual handling. Part 1. Lifting and Carrying. General requirements.*
- ISO 11228-2 2007, *System of standards for labor safety. Ergonomics. Manual handling. Part 2. Pushing and pulling.*
- ISO 11228-3 2007, *System of standards for labor safety. Ergonomics. Manual handling. Part 3. Handling of low loads at high frequency.*
- ISO 12100-1:2003 + A1:2009 2009, *Safety of machinery. Basic concepts, general principles for design. Part 1: Basic terminology, methodology.*
- ISO/TR 12295 2014, *Ergonomics. Application document for International Standards on manual handling (ISO 11228-1, ISO 11228-2 and ISO 11228-3) and evaluation of static working postures (ISO 11226). Technical Report.*
- ISO 14738 2002, *Safety of machinery. Anthropometric requirements for the design of workstations at machinery.*
- ISO 45001 2016, *Occupational health and safety.* Available: <http://www.iso45001assessment.com/registration.html> [2016, june, 22].
- Jackson, P.R. & Mullarkey, S. 2000, "Lean production and health in garment manufacture. ", *Journal of Occupational Health Psychology*, vol. 5, no. 2, pp. 231-245.
- Jackson, P.R. & Martin, R. 1996, "Impact of just-in-time on job content, employee attitudes and well-being: a longitudinal study", *Ergonomics*, vol. 39, no. 1, pp. 1-16.
- Jantunen, E. 2002, "A summary of methods applied to tool condition monitoring in drilling", *International Journal of Machine Tools & Manufacture*, pp. 997-1010.
- Jin, J., Li, J., Liao, G., Yu, X. & Viray, L.C.C. 2009, "Methodology for Potatoes Defects Detection with Computer Vision," *International Symposium on Information Processing ISIP'09*, pp. 346.
- Kanai, M., Inata, K., Fujii, S. & Kanda, Y. 1988, "Statistical characteristics of drill wear and drill life for the standardized performance tests.", *Annals of the CIRP*, vol. 27, no. 1, pp. 61-66.
- Kanerva, M. 2013, *Meat consumption in Europe: issues, trends and debates*, Universitat Bremen, Bremen.
- Kester, J. 2013, "A lean look at ergonomics", *Industrial engineer*, vol. 45, no. 3, pp. 28-32.

- Khojastehnazhand, M., Omid, M. & Tabatabaeefar, A. 2010, "Development of a lemon sorting system based on color and size," *African Journal of Plant Science*, vol. 4, no. 4, pp. 122-127.
- Kim, J., Welcome, D.E., Dong, R.G., Joon Song, W. & Hayden, C. 2007, "Time–frequency characterization of hand-transmitted, impulsive vibrations using analytic wavelet transform", *Journal of Sound and Vibration*, vol. 308, no. 1–2, pp. 98-111.
- King, N., Bechthold, M., Kane, A. & Michalatos, P. 2014, "Robotic tile placement: Tools, techniques and feasibility," *Automation in Construction*, vol. 39, pp. 161-166.
- Klein, J.A. 1991, "A Reexamination of Autonomy in Light of New Manufacturing Practices", *Human Relations*, vol. 44, no. 1, pp. 21-38.
- Kock, S., Jerregård, H., Lundberg, I. & Hedelind, M. 2011, "A concept for scalable, flexiela assembly automation – A technology study on a harmless dual-armed robot from ABB," *Proceedings of the International Symposium on Assembly and Manufacturing 2011*, pp. 25.
- Kohno, Y., Kondo, N., Iida, M., Kurita, M., Shiigi, T., Ogawa, Y., Kaichi, T. & Okamoto, S. 2011, "Development of a Mobile Grading Machine for Citrus Fruit," *Engineering in Agriculture, Environment and Food*, vol. 4, no. 1, pp. 7-11.
- Koukoulaki, T. 2014, "The impact of lean production on musculoskeletal and psychosocial risks: An examination of sociotechnical trends over 20 years", *Applied Ergonomics*, vol. 45, no. 2, pp. 198-212.
- Kozak, D. 2015, , *3 Key Ways Automation Reduces Safety and Ergonomic Concerns*. Available: <http://info.seegrid.com/blog/3-key-ways-automation-reduces-safety-and-ergonomic-concerns> [2016, April/13].
- Krüger, J., Lien, T.K. & Verl, A. 2009, "Cooperation of human and machines in assembly lines", *CIRP Annals - Manufacturing Technology*, vol. 58, no. 2, pp. 628-646.
- Kuijjer, P. Paul F. M., Visser, B. & Kemper, H.C.G. 1999, "Job rotation as a factor in reducing physical workload at a refuse collecting department", *Ergonomics*, vol. 42, no. 9, pp. 1167-1178.
- Kumar, V., Prasanthi, I. & Leena, A. 2008, "Robotics and Automation in Construction Industry" in American Society of Civil Engineers, pp. 1-9.
- Kusuda, Y. 2011, "Robots at FOOMA Japan: a food machinery and technology exhibition," *Industrial Robot*, vol. 38, no. 6, pp. 572-576.



- Leroyer, A., Kraemer-Heriaud, H., Marescaux, L. & Frimat, P. 2006, "Prospective evaluation of the impact of a change in the organization of work on perceived stress and health in assembly-line workers in an automobile plant", *Revue d'Épidémiologie et de Santé Publique*, vol. 54, no. 1, pp. 15-25.
- Lien, T.K. & Rasch, F.O. 2001, "Hybrid Automatic-manual Assembly Systems", *CIRP Annals - Manufacturing Technology*, vol. 50, no. 1, pp. 21-24.
- Lloyd, C. & James, S. 2008, "Too much pressure? Retailer power and occupational health and safety in the food processing industry", *Work, Employment & Society*, vol. 22, no. 4, pp. 713-730.
- Lorente, D., Zude, M., Regen, C., Palou, L., Gómez-Sanchis, J. & Blasco, J. 2013, "Early decay detection in citrus fruit using laser-light backscattering imaging," *Postharvest Biology and Technology*, vol. 86, pp. 424-430.
- Madsen, N., Nielsen, U.J. & Mønsted, K. 2006, "Automation - the meat factory of the future," *Proceedings of 52nd International Congress of Meat Science and Technology ICoMST 2006*.
- Madsen, K.B. & Nielsen, J.U. 2002, "Automated meat processing" in *Meat Processing*, eds. J. Kerry, J. Kerry & D. Ledward, Woodhead Publishing, , pp. 283-296.
- Maeda, J. 1994, "Development and Application of the SMART System" in *Automation and Robotics in Construction XI*, ed. D.A. CHAMBERLAIN, Elsevier, Oxford, pp. 457-464.
- McDowell, T.W., Wiker, S.F., Dong, R.G. & Welcome, D.E. 2007, "Effects of vibration on grip and push force-recall performance", *International Journal of Industrial Ergonomics*, vol. 37, no. 3, pp. 257-266.
- McMurray, G. 2013, "Robotics and automation in the poultry industry: current technology and future trends" in *Robotics and Automation in the Food Industry*, ed. D.G. Caldwell, Woodhead Publishing, , pp. 329-353.
- Messac, A., Ismail Yahaya, A. & Mattson, C.A. 2003, "The normalized normal constraint method for generating the Pareto frontier", *Structural and multidisciplinary optimization*, vol. 25, no. 2, pp. 86-98.
- Ministero del Lavoro e delle Politiche Sociali 2011, *DPR 177/2011 Regolamento recante norme per la qualificazione delle imprese e dei lavoratori autonomi operanti in ambienti sospetti di inquinamento o confinanti*.

- Ministero del Lavoro e delle Politiche Sociali 2008, *D.lgs 9 aprile 2008, n.81 Testo unico sulla salute e sicurezza sul lavoro*.
- Moghaddam, M. & Nof, S.Y. 2015, "Real-time administration of tool sharing and best matching to enhance assembly lines balanceability and flexibility", *Mechatronics*, vol. 31, pp. 147-157.
- Monforton, C. 2013, , *Harsh working conditions in US poultry and meatpacking plants violate human rights, OAS Commission to review the claim*. Available: <http://scienceblogs.com/thepumphandle/2013/06/25/harsh-working-conditions-in-us-poultry-and-meatpacking-plants-violate-human-rights-oas-commission-to-review-the-claim/> [2014, December].
- Morales, G., Herbzman, Z. & Najafi, F.T. 1999, "Robots and construction automation," *Proceedings of the 16th ISARC*, pp. 283.
- Naito, J., Obinata, G., Nakayama, A. & Hase, K. 2007, "Development of a Wearable Robot for Assisting Carpentry Workers," *International Journal of Advanced Robotic Systems*.
- Neumann, W.P., Kihlberg, S., Medbo, P., Mathiassen, S.E. & Winkel, J. 2002, "A case study evaluating the ergonomic and productivity impacts of partial automation strategies in the electronics industry", *International Journal of Production Research*, vol. 40, no. 16, pp. 4059-4075.
- Nielsen, J.U., Fertin, C. & Christensen, H. 2005, "Up-to-date equipment for pig slaughtering, cutting and boning and their influence on product safety", *Technologija Mesa*, vol. 46, pp. 62-63-66.
- Nielsen, J.U., Madsen, N.T. & Clarke, R. 2014, "AUTOMATION IN THE MEAT INDUSTRY | Slaughter Line Operation" in *Encyclopedia of Meat Sciences (Second Edition)*, eds. M. Dikeman, & C. Devine, Academic Press, Oxford, pp. 43-52.
- NIOSH 2002, *NIOSH hazard review: health effects of occupational exposure to respirable crystalline silica*. DHHS/ NIOSH Publication No. 2002-129. NIOSH, Cincinnati, OH.
- Nunes, I.L. & Machado, V.C. 2007, "Merging ergonomic principles into lean manufacturing", *IIE Annual Conference and Expo 2007 - Industrial Engineering's Critical Role in a Flat World, May 19, 2007 - May 23* Institute of Industrial Engineers, Nashville, TN, United states, 2007, pp. 836.
- Nur, B.A.M., Syed, K.A., Zaipatimah, A., Wong, B.Y., Aidil, A.Z.A. & Zainul, A.M.S. 2009, "Agricultural produce Sorting and Grading using Support Vector Machines and Fuzzy

Logic," *Signal and Image Processing Applications (ICSIPA), 2009 IEEE International Conference on*, pp. 391.

Occhipinti, E. 1998, "OCRA: a concise index for the assessment of exposure to repetitive movements of the upper limbs", *Ergonomics*, vol. 41, no. 9, pp. 1290-1311.

Ólafsdóttir, H. & Rafnsson, V. 1998, "Increase in musculoskeletal symptoms of upper limbs among women after introduction of the flow-line in fish-fillet plants", *International Journal of Industrial Ergonomics*, vol. 21, no. 1, pp. 69-77.

Oraby, S.E. & Hayhurst, D.R. 2004, "Tool life determination based on the measurement of wear and tool force ratio variation", *International Journal of Machine Tools and Manufacture*, vol. 44, no. 12–13, pp. 1261-1269.

Osborne, A., Blake, C., Fullen, B.M., Meredith, D., Phelan, J., McNamara, J. & Cunningham, C. 2012, "Risk factors for musculoskeletal disorders among farm owners and farm workers: A systematic review," *American Journal of Industrial Medicine*, vol. 55, no. 4, pp. 376-389.

OSHA 2004, *Guidelines for retail grocery stores: Ergonomics for the prevention of musculoskeletal disorders*, Occupational Safety and Health Administration (OSHA) U.S. Department of Labor.

OSHA 2002, *3071 Job Hazard Analysis*, U.S. Department of Labor Occupational Safety and Health Administration (OSHA).

OSHAa, *OSHA's Safety Pays Program*. Available:  
[www.osha.gov/dcsp/smallbusiness/safetypays/estimator.html](http://www.osha.gov/dcsp/smallbusiness/safetypays/estimator.html) [2015, March].

OSHA b, *Safety and Health Regulations for Construction. General Safety and Health Provisions. Safety training and education*, U.S. Department of Labor, Occupational Safety and Health Administration (OSHA).

Othman, M., Bhuiyan, N. & Gouw, G.J. 2012, "Integrating workers' differences into workforce planning", *Computers & Industrial Engineering*, vol. 63, no. 4, pp. 1096-1106.

Pelmear, P.L., Taylor, W. & Wasserman, D.E. 1992, *Hand-arm Vibration: A Comprehensive Guide for Occupational Health Professionals*, Van Nostrand Reinhold.

Pelmear, P.L. & Leong, D. 2000, "Review of Occupational Standards and Guidelines for Hand-Arm (Segmental) Vibration Syndrome (HAVS)", *Applied Occupational and Environmental Hygiene*, vol. 15, no. 3, pp. 291-302.

- Purnell, G. & Caldwell, D.G. 2012, *Robotics and automation in meat processing*, Woodhead Publishing Limited.
- Purnell, G. 1998, "Robotic equipment in the meat industry", *Meat Science*, vol. 49, no. SUPPL. 1, pp. S297.
- Purnell, G. & Grimsby Institute of Further and Higher Education 2013, "Robotics and automation in meat processing" in *Robotics and Automation in the Food Industry*, ed. D.G. Caldwell, Woodhead Publishing, , pp. 304-328.
- Rajabalipour Cheshmehgaz, H. 2012, "Accumulated risk of body postures in assembly line balancing problem and modeling through a multi-criteria fuzzy-genetic algorithm.", *Computers & Industrial Engineering*, vol. 63, no. 2, pp. 503-512.
- Razmjoo, N., Mousavi, B.S. & Soleymani, F. 2012, "A real-time mathematical computer method for potato inspection using machine vision," *Computers & Mathematics with Applications*, vol. 63, no. 1, pp. 268-279.
- Regione Emilia Romagna 2014, , *Agricultural and food production. The role of the Region Emilia Romagna*. Available: <http://agricoltura.regione.emilia-romagna.it/produzioni-agroalimentari/temi/allevare-animali> [2014, 11/4].
- Remadna, M. & Rigal, J.F. 2006, "Evolution during time of tool wear and cutting forces in the case of hard turning with CBN inserts", *Journal of Materials Processing Technology*, vol. 178, no. 1–3, pp. 67-75.
- Rempel, D., Barr, A. & Antonucci, A. 2015, "Evaluation of handle vibration for hammer drills using a new test bench system", *Proceedings of the International Conference on Hand-Arm Vibration*, pp. 31.
- Rempel, D., Star, D., Barr, A. & Janowitz, I. 2010, "Overhead drilling: Comparing three bases for aligning a drilling jig to vertical", *Journal of Safety Research*, vol. 41, no. 3, pp. 247-251.
- Resnick, M.L. & Zanotti, A. 1997, "Using ergonomics to target productivity improvements", *Computers & Industrial Engineering*, vol. 33, no. 1–2, pp. 185-188.
- Rodacki, A.L.F. & Vieira, J.E. 2010, "The effect of different supermarket checkout workstations on trunk kinematics of checkout operators," *Brazilian Journal of Physical Therapy*, vol. 14, no. 1, pp. 38-44.
- Roscher, R., Herzog, K., Kunkel, A., Kicherer, A., Tlopf, R. & Forstner, W. 2014, "Automated Image Analysis Framework for High-throughput Determination of Grapevine

- Berry Sizes Using Conditional Random Fields," *Comput.Electron.Agric.*, vol. 100, pp. 148-158.
- Sammons, P.J., Furukawa, T. & Bulgin, A. 2005, "Autonomous Pesticide Spraying Robot for use in a Greenhouse Abstract," *Proceedings of Australian Conference on Robotics and Automation*, pp. 1.
- Sanford, J., Milchus, K., Mullick, A. & Vargas, C.A. 2008, *Universal design of a future grocery retail checkstand*, GIT, Atlanta, Georgia USA.
- Saurin, T. & Ferreira, C.F. 2009, "The impacts of lean production on working conditions: A case study of a harvester assembly line in Brazil", *International Journal of Industrial Ergonomics*, vol. 39, no. 2, pp. 403-412.
- Schafer, D., Abdelhamid, T.S., Mitropoulos, P. & Howell, G.A. 2008, "Resilience Engineering: A new paradigm for safety in lean construction systems", *Proceedings of IGLC16: 16th Annual Conference of the International Group for Lean Construction*, July 16-18 2008, pp. 723.
- Schouteten, R. & Benders, J. 2004, "Lean production assessed by Karasek's job demand-job control model", *Economic and Industrial Democracy*, vol. 25, no. 3, pp. 347-373.
- Schyns, B. 2007, *Implicit theory of leadership*, SAGE Publications, Inc., Thousand Oaks, CA.
- Şener, S., Sarıdoğan, E., Staub, S., Deros, B.M., Daruis, D.D.I. & Basir, I.M. 2015, "World Conference on Technology, Innovation and Entrepreneurship A Study on Ergonomic Awareness among Workers Performing Manual Material Handling Activities," *Procedia - Social and Behavioral Sciences*, vol. 195, pp. 1666-1673.
- Shikdar, A.A. & Sawaqed, N.M. 2004, "Ergonomics, and occupational health and safety in the oil industry: a managers' response", *Computers & Industrial Engineering*, vol. 47, no. 2–3, pp. 223-232.
- Shoaf, C., Genaidy, A., Karwowski, W. & Huang, S. 2004, "Improving performance and quality of working life: A model for organizational health assessment in emerging enterprises", *Human Factors and Ergonomics in Manufacturing*, vol. 14, no. 1, pp. 81-95.
- Shunmugesh, K. & Panneerselvam, K. "Machinability study of Carbon Fiber Reinforced Polymer in the longitudinal and transverse direction and optimization of process parameters using PSO–GSA", *Engineering Science and Technology, an International Journal*, .
- Sinor, A. & Warren, T.M. 1989, "Drag Bit Wear Model", .

- Smith, R.T. 2003, "Growing an ergonomics culture in manufacturing", *Proceedings of the Institution of Mechanical Engineers, Part B: Journal of Engineering Manufacture*, vol. 217, no. 7, pp. 1027-1030.
- Snook, S.H. 1978, "The ergonomics society. The society's lecture 1978. The design of manual handling tasks," *Ergonomics*, vol. 21, no. 12, pp. 963.
- Sorour, M.T. 2011, "Development of Roller-Based Interior Wall Painting Robot," *International Journal of Mechanical, Aerospace, Industrial, Mechatronic and Manufacturing Engineering*, vol. 5, pp. 2308-2316.
- Sprigg, C.A. & Jackson, P.R. 2006, "Call centers as lean service environments: job-related strain and the mediating role of work design. ", *Journal of Occupational Health Psychology*, vol. 11, no. 2, pp. 197-212.
- Su, A.T., Maeda, S., Fukumoto, J., Miyai, N., Isahak, M., Yoshioka, A., Nakajima, R., Bulgiba, A. & Miyashita, K. 2014, "A Cross Sectional Study on Hand-arm Vibration Syndrome among a Group of Tree Fellers in a Tropical Environment", *Industrial health*, vol. 52, no. 4, pp. 367-376.
- SUVA 2003, *Form. 44061.i Ergonomia. Un fattore di successo per ogni impresa.*, SUVA.
- SUVA 2016. [www.suva.ch](http://www.suva.ch).
- Suzaki, K. 1987, *The New Manufacturing Challenge: Techniques for Continuous Improvement*, , New York, NY: The Free Press.
- Tanigaki, K., Fujiura, T., Akase, A. & Imagawa, J. 2008, "Cherry-harvesting Robot," *Comput.Electron.Agric.*, vol. 63, no. 1, pp. 65-72.
- Taylor, F. 1907, *On the art of cutting metals*, American Society of mechanical engineers, New York.
- Templer, R.G., Nicholls, H.R. & Nicolle, T. 1999, "Robotics for meat processing - from research to commercialization," *Industrial Robot*, vol. 26, no. 4, pp. 290-296.
- Teoh, C.C. & Mohd Syaifudin, A.R. 2007, "Image processing and analysis techniques for estimating weight of Chokanan mangoes (Teknik pemprosesan imej dan analisis imej untuk menganggarkan berat mangga Chokanan)," *Journal on Tropical Agriculture and Food Science*, vol. 35, no. 1, pp. 183-190.

- Tharmmaphornphilas, W Green, B Carnahan, B J Norman, B A. 2003, "Applying mathematical modeling to create job rotation schedules for minimizing occupational noise exposure", *AIHA journal*, vol. 64, no. 3, pp. 401.
- Tomas, U. & Ganiron, J. 2014, "Size Properties of Mangoes using Image Analysis," *International Journal of Bio-Science and Bio-Technology*, vol. 6, no. 2, pp. 31-42.
- Ukey, P.D. & Unde, P. 2010, "Design, development and performance evaluation of sapota fruit grader," *International Journal of Agricultural Engineering*, vol. 3, no. 1, pp. 35-39.
- United States Government Accountability Office 2005, *Workplace Safety and Health. Safety in the meat and poultry industry, while Improving, could be further strengthened.*
- United States Government Accountability Office 2005, *Workplace Safety and Health. Safety in the meat and poultry industry, while Improving, could be further strengthened.*
- Van Henten, E.J., Van't Slot, D.A., Hol, C.W.J. & Van Willigenburg, L.G. 2009, "Optimal manipulator design for a cucumber harvesting robot," *Computers and Electronics in Agriculture*, vol. 65, no. 2, pp. 247-257.
- Vieira, L., Balbinotti, G., Varasquin, A. & Gontijo, L. 2012, "Ergonomics and Kaizen as strategies for competitiveness: a theoretical and practical in an automotive industry.", *Work*, vol. 41, no. 1, pp. 1756-1762.
- Wadie, I., Maddock, N., Purnell, G., Khodabandehloo, K., Crooks, A., Shacklock, A. & West, D. 1995, "Robots for the meat industry", *Industrial Robot*, vol. 22, no. 5, pp. 22-26.
- Walder, J., Karlin, J. & Kerk, C. 2007, *Integrated Lean Thinking & Ergonomics: Utilizing Material Handling Assist Device Solutions for a Productive Workplace*, Charlotte, North Carolina.
- Waters, T. 1993, "Revised NIOSH equation for the design and evaluation of manual lifting tasks," *Ergonomics*, vol. 36, no. 7, pp. 749-776.
- Waters, T.R., Putz-Anderson, V. & Garg, A. 1994, *Applications Manual for the Revised NIOSH Lifting Equation*, Cincinnati, Ohio: NIOSH.
- Welcome, D.E., Dong, R.G., Xu, X.S., Warren, C. & McDowell, T.W. 2014, "The effects of vibration-reducing gloves on finger vibration", *International Journal of Industrial Ergonomics*, vol. 44, no. 1, pp. 45-59.

- Welcome, D.E., Dong, R.G., Xu, X.S., Warren, C., McDowell, T.W. & Wu, J.Z. 2015, "An examination of the vibration transmissibility of the hand-arm system in three orthogonal directions", *International Journal of Industrial Ergonomics*, vol. 45, pp. 21-34.
- Wise, J. 2003, "Hard-rock drilling performance of a conventional PDC drag bit operated with and without benefit of real-time downhole diagnostics", *Transactions*, vol. 27, pp. 197-205.
- WITRON a, *E-DPS Ergonomic Dynamic Picking System - Ergonomic picking by pick-to-tote*. Available: [http://www.witron.de/uploads/media/Broschuere\\_EDPS.pdf](http://www.witron.de/uploads/media/Broschuere_EDPS.pdf) [2016, July 11].
- WITRON b, *SRS Self Replenishment System*. Available: [http://www.witron.de/uploads/media/Broschuere\\_SRS.pdf](http://www.witron.de/uploads/media/Broschuere_SRS.pdf) [2016, July, 11].
- Wolf, A. 1999, *High-speed packaging using robots*, Meat Automation No.2 edn.
- Wygant, R.M., White, B.E. & Hunt, D. 1993, "Combining ergonomics and work measurement for job analysis", *Computers & Industrial Engineering*, vol. 25, no. 1-4, pp. 423-426.
- Xu, Z., Ko, J., Cochran, D. & Jung, M. 2012, "Design of assembly lines with the concurrent consideration of productivity and upper extremity musculoskeletal disorders using linear models", *Computers & Industrial Engineering*, vol. 62, no. 2, pp. 431-441.
- Xu, X.S., Dong, R.G., Welcome, D.E., Warren, C. & McDowell, T.W. 2015, "An examination of an adapter method for measuring the vibration transmitted to the human arms", *Measurement*, vol. 73, pp. 318-334.
- Yahiaoui, M., Paris, J.-., Delbé, K., Denape, J., Gerbaud, L., Colin, C., Ther, O. & Dourfaye, A. 2016, "Quality and wear behavior of graded polycrystalline diamond compact cutters", *International Journal of Refractory Metals and Hard Materials*, vol. 56, pp. 87-95.
- Yan, G., Yue, W., Meng, D., Lin, F., Wu, Z. & Wang, C. 2016, "Wear performances and mechanisms of ultrahard polycrystalline diamond composite material grinded against granite", *International Journal of Refractory Metals and Hard Materials*, vol. 54, pp. 46-53.
- Yu, S.N., Lee, S.Y., Han, C.S., Lee, K.Y. & Lee, S.H. 2007, "Development of the curtain wall installation robot: Performance and efficiency tests at a construction site," *Autonomous Robots*, vol. 22, no. 3, pp. 281-291.
- Yusoff, S., Arezes, P., Costa, N., Arezes, P., Baptista, J.S., Barroso, M.P., Carneiro, P., Costa, N., Melo, R., Miguel, A.S., Perestrelo, G., Cordeiro, P. & Portuguese, S.O.C.



2013, "The Integration of Lean Manufacturing and Ergonomics Approach in Workplace Design", *Occupational Safety and Hygiene - SHO2013*, pp. 579.

Zacny, K.A. & Cooper, G., A. 2007, "Coring basalt under Mars low pressure conditions", *International Journal of Mars Science and Exploration*, vol. 3, pp. 1-11.

Zecchi, G. & Menoni, O. 2006, "Indicatori per la verifica di efficacia di un percorso preventivo nella movimentazione manuale dei pazienti," *Atti del XXVIII ICOH Congress*.

# 3 SAFETY IN CONFINED SPACES

---

Confined spaces are defined as limited or restricted areas not designed for continuous occupancy where employees enter and perform a specific task. Examples of confined spaces include, but are not limited to tanks, vessels, silos and pipelines.

Work in confined spaces poses a significant risk to workers and rescuers involved in the emergency response when an accident occurs. The high risk of confined space work can lead to extremely dangerous situations. Every year, confined space work causes fatal accidents and injuries. Despite standards and regulations define the safety requirements for such activities, injuries and fatalities still occur. Furthermore, the on-site inspections after accidents often reveal that both employers and employees fail to implement safe entry procedures. Removing the risk is possible by avoiding the worker entry, but many activities require the presence of the operator inside the confined space to perform manual tasks.

Several publications, reports and recent news describe the great impact of such risks on the occupational safety level, showing high accident rates and multiple-fatality incidents. Common causes of accident in confined spaces are fire, explosion, spontaneous combustion and contact with high temperature extremes (OSHA 2002). Statistics show that the activity of the victim within the space is the main cause of accident. Particularly, the victim causes the presence of toxic gas or oxygen deficiency in several accidents due to hazardous atmospheric conditions, while accidents with entrapment are typically due to the attempt to unclog an accumulated deposit of materials.

Recent pilot projects have been developed focusing on the application of Internet of Things (IOT) technologies for improving safety and emergency management in complex production systems (Elia & Gnoni 2013, Yang et al. 2013). Few applications could be outlined for managing hazards in confined spaces even if the potential is high. As an example, portable wireless gas detection systems provide real data on atmospheric conditions within the confined area, allowing a quicker and a more efficient emergency response by alerting workers and safety managers in the case of toxic or flammable gas detection.

This chapter proposes a novel approach to the management of risks in confined spaces. Firstly, a review of the international regulations on confined spaces and a brief analysis of accidents due to confined space work introduce the confined space problem and the risks of job activities in confined spaces (Section 3.1.1). After a brief review of technical solutions for non-entry confined space work (Section 3.1.2), Section 3.2 introduces two administrative controls based on IOT technologies for the risk reduction. The first is a framework for analyzing the hazards and the work procedures in confined spaces prior to entry (Section 3.2.2). The framework helps to define the impact of IOT technologies for preventing and managing confined space risks. The latter is a multi-criteria decision tool for the evaluation of

the potential contribution of IOT technologies to prevent and control the risks of confined space work (Section 3.2.3). Finally, the main characteristics of an engineering control for the risk elimination of activities in confined spaces are introduced in Section 3.3. The proposed control is an online tool for the identification of confined spaces. The aim is to help workers and practitioners to identify confined spaces and prevent the access of workers into such high-risk areas.

# 3.1 LITERATURE REVIEW ON CONFINED SPACES

## 3.1.1 Review of regulations in force and accidents in confined spaces

### 3.1.1.1 International regulation on confined space work

Despite the worldwide regulation and standard-setting efforts in outlining procedures and recommendations for safe confined space work, the recent statistics show that several fatal incidents still occur (Burllet-Vienney, Chinniah et al. 2014). Confined space work procedures are not internationally standardized. Industrialized countries adopt different approaches to addressing this issue. The local legislation in force reflects the local strategy for addressing the risk of confined space work.

American standards and regulations define the confined space geometric characteristics, together with the guidelines for job hazard analysis, hazard elimination, and the procedures for safe confined space work. The U.S. legislation widely investigates the risk of activities within confined spaces, providing exhaustive guidelines and procedures for safe confined space work. The following Table 3.1 shows a brief overview of the worldwide rules and standards con confined spaces.

Table 3.1 Standards for confined space

Nation	Standard/Guide	Title	Field of intervention
USA	OSHA 1910.146 (OSHA 1993)	Occupational Safety and Health Standards. General Environmental Controls. Permit-Required Confined Spaces.	Definition of confined space in general industry, requirements for practices and procedures to protect employees from the hazards of permit-required confined spaces.
	OSHA 1926.21 (OSHAe)	Safety and Health Regulations for Construction. General Safety and Health Provisions. Safety training and education.	Extension of the definition of confined space, including open top spaces more than 4 feet in depth.
	OSHA 29 CFR 1926 Subpart AA (OSHA 2015)	Safety and Health Regulations for Construction. Confined Spaces in Construction. Authority for 1926 Subpart AA.	Confined spaces in construction standard.
	OSHA 29 CFR 1910.272 (OSHAAd)	Occupational Safety and Health Standards. Special Industries. Grain handling facilities.	Grain handling facilities.
	OSHA 29 CFR 1915 Subpart B (OSHAc)	Occup. Safety and Health Standards for Shipyard Employment. Confined and Enclosed Spaces and Other Dangerous Atmospheres in Shipyard Employment.	Confined and Enclosed Spaces and Other Dangerous Atmospheres in Shipyard Employment.
	OSHA 3138-01R (OSHA 2004b)	Permit-Required Confined Spaces.	Informational booklet including a decision flow chart to help in identifying permit-required confined spaces and

			providing signage requirements.
	OSHA 3071 (OSHA 2002)	Job Hazard Analysis.	Requirements and guidelines for the job hazard analysis.
	NIOSH 80-106 (1979)	Criteria for a Recommended Standard: Working in Confined Spaces.	Criteria for working in confined spaces, investigating the atmosphere characteristics of the confined areas.
	NIOSH 86-110 (1986)	NIOSH Alert: Request for Assistance in Preventing Occupational Fatalities in Confined Spaces.	Case reports of fatal incidents concerning confined space work.
	NIOSH 87-113 (1987)	A guide to safety in confined spaces.	Guidelines for safe confined space work.
	NOSH 94-103 (1994)	Worker deaths in confined spaces.	Data and investigative reports of fatal incidents involving workers who entered confined spaces.
	ANSI/ISA 92.04.01 Part I-2007 (2007)	Performance Requirements for Instruments Used to Detect Oxygen-Deficient/Oxygen-Enriched Atmospheres.	Requirements for instruments used to provide a warning of the presence of oxygen-deficient or oxygen-enriched atmospheres.
	ANSI/ASSE Z117.1-2009 (2009)	Safety Requirements for Confined Spaces with Comparison Document for versions 1995, 2003 and 2009.	Safety requirements to be followed while entering, exiting and working in confined spaces at normal atmospheric pressure.
	ASTM D4276-02 (2012)	Standard Practice for Confined Area Entry.	Procedures to protect the health and safety of workers required to enter confined spaces, and practice with specific safety steps to be taken for entry into confined spaces.
UK	HSE (1997)	Confined Space Regulations.	Requirements for safe confined space work. Apply where the assessment identifies risks of serious injury from work in confined spaces.
	HSE (1999)	The Management of Health and Safety at Work Regulations.	Require employers and self-employed people to identify the hazards present in confined spaces, assessing the risks and determining what precautions to take.
	HSE (2014)	Confined Space Regulations 1997. Approved Code of Practice, Regulations and Guidance.	Approved Code of Practice (ACOP) and guidance for those involved in work within confined spaces, those who employ or train such people and those that represent them.
Swiss	SUVA 01416 (2004),	Direttive concernenti i lavori all'interno di recipienti e locali stretti.	Guidelines for safe confined space work.
	SUVA 44040.i (2010a)	Ambienti di lavoro ristretti: cosa fare contro il pericolo di esplosione, intossicazione e asfissia?	Guidelines and checklist for maintenance activities in enclosed areas.
	SUVA 44062.i (2010b),	Sicurezza nei lavori all'interno di pozzi, fosse e canalizzazioni.	Guidelines for activities in pits, sewers and pipelines.
	SUVA CFSL:6806i (2012),	Lista di controllo CFSL. Fosse d'ispezione e manutenzione.	Checklists for inspection and maintenance in confined spaces.
	SUVA 67103.i (2013)	Lista di controllo. Saldatura, taglio, brasatura e riscaldamento: procedimento a fiamma.	Checklist for welding, cutting and other hot work.
Italy	TU D.Lgs. 81/2008 (2008)	Testo Unico sulla salute e sicurezza sul Lavoro.	Regulation on occupational safety and health in general industry.
	DPR 177/2011 (2011)	Regolamento recante norme per la qualificazione delle imprese e dei lavoratori autonomi operanti in ambienti sospetti di inquinamento o confinanti.	Requirements for confined space personnel and operating companies.

The 29 CFR 1910.146 (1993) standard of the American OSHA is widely known as the Permit-Required Confined Spaces (PRCS) standard for confined space work in general industry. Such standard provides a general definition of “confined space”, together with requirements for practices and procedures to protect employees in general industry from the hazards of entry into permit-required confined spaces. The PRCS defines “Confined space” as a space

that is large enough and configured that an employee can enter and perform work, has limited openings of entry or exit and is not designed for continuous occupancy (U.S. Department of Labor, Occupational Safety and Health Administration 2004 and 2014). The OSHA 29 CFR 1910.146 is considered one of the most difficult OSHA's standards to comprehend, likely is the hardest with which to comply (Taylor 2011). Confined spaces are not limited to enclosed spaces as storage tanks, process vessels, sewers and pipelines. The OSHA 1926.21 enlarges the definition of confined spaces. For purposes of such standard, confined or enclosed space means any space having a limited means of egress, which is subject to the accumulation of toxic or flammable contaminants or has an oxygen deficient atmosphere. As a consequence, confined or enclosed spaces include open top spaces more than 4 feet in depth such as pits, tubs, vaults, and vessels.

The 29 CFR 1910.146 protects employees who enter confined spaces while engaged in general industry work. This standard has not been extended to cover employees entering confined spaces while engaged in specific industries, as construction work or confined space workers in agriculture because of unique characteristics of such worksites. The US legislation provides precise standards for industries exempt from OSHA's 29 CFR 1910.146, such as construction, agriculture and shipyard work. For example, the new rule OSHA 29 CFR 1926 Subpart AA (2015) protects construction workers in confined spaces, while the OSHA 1910.272 applies to grain handling facilities and the OSHA 29 CFR 1915 is for confined spaces in shipyard employment.

Despite the numerous directions of the OSHA's standards, employers in general industry have difficulty determining if spaces are permit-required confined spaces. The OSHA 3138-01R (2004) provides a decision flow chart to help identifying permit-required confined spaces and providing signage requirements.

The US legislation explores the risk of confined space work from multiple perspectives, to help employers and employees in recognizing such hazardous workplaces. The risk of confined spaces is due to both the characteristics of the confined area and the characteristics of the task to be performed. Activities such as cleaning, repairing and welding can create a hazardous environment, when performed within the confined area.

A job hazard analysis aims to identify hazards before they occur, eliminating or reducing them to an acceptable risk level. The OSHA 3071 (2002) Standard proposes a stepwise procedure for the job hazard analysis: task description, hazard description and hazard controls. After reviewing the task characteristics and the types of hazard, the procedure considers the control methods for the elimination or the reduction of the identified hazards. Control methods include engineering controls, administrative controls and Personal Protective Equipment (PPE), such as respirators and protective clothing. Engineering controls physically change a machine or work environment to prevent employee exposure to the hazard. If engineering controls are not feasible, the OSHA 3071 encourages the adoption of administrative controls, e.g. written operating procedures, work permits, and safe work practices. Finally, PPE is an

acceptable control method when engineering controls do not totally eliminate the hazard or when safe work practices do not provide sufficient additional protection. The NIOSH provides criteria and guidelines for preventing occupational fatalities in confined spaces (see in Table 3.1). The NIOSH publication 80-106 (1979) outlines a classification system for confined spaces, investigating the atmosphere characteristics of the confined area. The publication provides a checklist of factors to consider for the analysis of hazardous atmospheres, based on the content of oxygen, flammable substances and potential or toxic air contaminants. Further NIOSH publications provide guidelines for the recognition of confined spaces and their general physical hazards, together with statistics and findings on fatalities in confined spaces (NIOSH 1986, NIOSH 1987, NIOSH 1994). The American National Standard Institute (ANSI) and the American Society for Testing and Materials (ASTM) provide further standard practices for confined spaces and performance requirements for instruments used to detect the atmosphere of confined areas.

A European Standard for confined space work is not yet available. The European Regulation on confined spaces is fragmented. The procedures and practices for safe confined space work apply to the country where the rules are published. The Britain legislation on confined spaces is based on The Management of Health and Safety at Work Regulations (1999) and the Confined Spaces Regulations (1997). The former require workers to identify the hazards present, to assess the risks and to determine what precautions to take. The latter apply where the assessment identifies risks of serious injury from work in confined spaces. Particularly, the Health and Safe Executive (HSE) of the United Kingdom provides an approved code of practice (2014) and guidance on the duties in the Confined Spaces Regulations. The code of practice is for those involved in work within confined space, those who employ or train such people and those that represent them. Such guidance applies to all industry sectors with the exception of diving operations and below ground in a mine, which have specific legislation.

The Swiss approach to confined space issues is based on the type of confined space and activity to perform. The Swiss National Accident Insurance Fund (SUVA) provides several checklists for different confined space activities. Such checklists help confined space workers to analyze the hazard of typical confined spaces and activities to perform (SUVA 2004, SUVA 2010a, SUVA 2010b, SUVA 2012, SUVA 2013).

The Italian legislation does not provide a specific regulation addressing the multiple risks of confined space work as it provides general requirements for work in polluted-suspected environments. Italian employers and employees are required to follow the directions of the TU D.Lgs. 81/2008 (2010), the Italian regulation on occupational safety and health. Such regulation provides requirements for occupational safety and risk assessment methods in general industry. The Italian specific rule for confined spaces defines the requirements for confined space personnel and operating companies, but no guidelines for safe confined space work are provided.

### 3.1.1.2 Brief accident analysis

Confined space work is a high-risk activity, posing a serious life-threatening hazard to the workers who perform it. Hazards in confined space are very complex to evaluate and manage. The type of place together with the type of task could increase the risk level in confined space. The following quantitative analysis investigates data regarding accidents in confined space collected by NIOSH from 1985 to 2012: the total number of accident is 141 causing 184 fatalities with about 1.3 as an average fatality rate for accident. Firstly, data have been grouped based on type of accident cause; 7 categories have been introduced based on hazard analysis such as Asphyxiation, Engulfment, Poisoning, Oxygen deficiency, Drowning, Explosion, and Electrocution. Data classification is proposed in Figure 3.1: if the total number of occurrence is less than 3, data have been grouped in the “other” category. Results show Asphyxiation as the most frequent cause of death when an accident in confined space occurs.

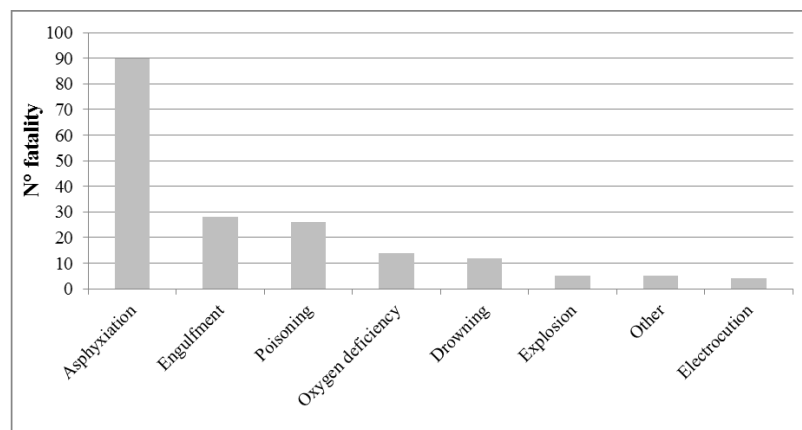

Figure 3.1 NIOSH accidents classification based on causes and number of fatalities occurred in confined space.

Next, by analysing Italian statistics from 2001 to 2015 regarding accidents at confined spaces, data show similar condition. The total number of accident in the analysed period is equal to 20 accidents, which have caused 51 fatalities; in this case, the average fatality rate is higher. i.e. equal to about 2.25 fatality per accident. Results are depicted in Figure 3.2.



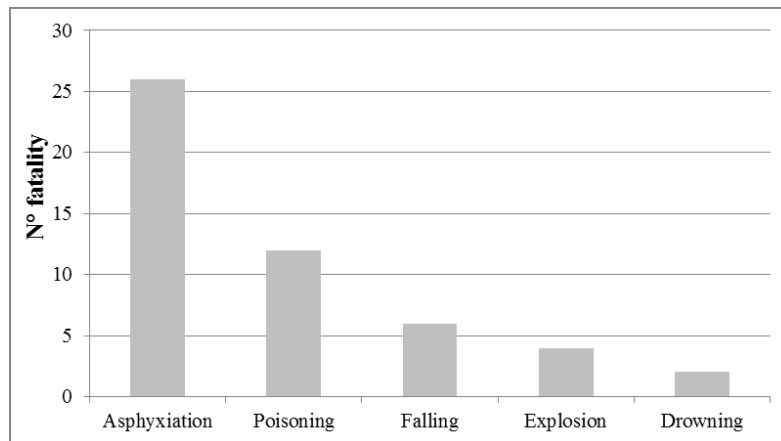

Figure 3.2 Italian accidents classification based on causes and number of fatalities occurred in confined space.

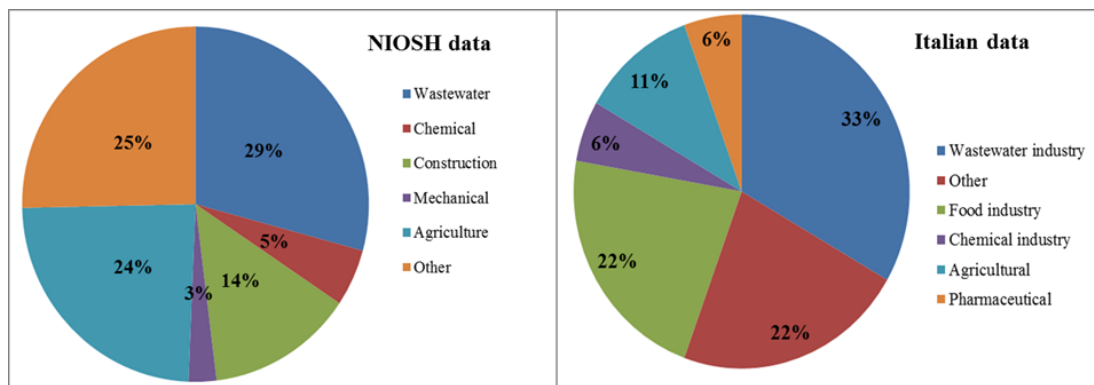

Figure 3.3 Classification of accidents based on the industrial sector.

Moreover, confined spaces hazards could be present in several workplaces such as chemical (e.g. reaction vessels), food (e.g. silos) and utility (e.g. sewers) sectors. Some areas may become confined spaces when work is carried out, or during their construction, fabrication or subsequent modification. Results are reported in Figure 3.3: for both samples of data the wastewater sector as the most hazardous one for confined space risk. Thus, by analysing technologies applied in these service systems, it has to be noted that several of these locations are below ground level and have stair entry for access to routine maintenance, inspection, testing, sampling and repairs. For NIOSH data, a relevant position could be outlined also for the agricultural sector: main examples of potential confined space in agricultural operations are silos, grain bins, manure pits, etc. For Italian data, another critical sector is the food industry: several examples are storage tanks, grape presses, fermentation tanks, utility vaults and vessels.

### 3.1.2 Review of technical solutions for confined space work

The numerous accidents and fatalities due to confined space work reveal that both employers and workers fail to identify confined space work hazards (Burllet-Vienney, Chinniah & Bahloul 2014). A recent accident led to the death of two workers who entered a tank to rescue a third man, who entered to clean the confined area. The three workers entered with no face protection or ventilation equipment. The emissions from the contents of the tank caused the illness of the first worker, who fell into the confined space, and the asphyxiation of the two rescuers (Bizzotto 2014).

Reducing accident and fatality occurrences is socially and technically challenging. The British Health and Safety Executive suggest avoiding entry to confined spaces, e.g. by doing the work from outside (HSE 2013). Avoiding entry is not always possible and manual workers need to access confined spaces, posing high risk to their safety and health. An effective method to perform the work task while eliminating the risk from confined space entry consists in replacing the manual operations with automated solutions. Benefits of automated confined space work are not limited to higher level of occupational safety. Automated technology achieves better performances in shorter time, offering lower downtime costs and higher efficiency (Pagcatipunan 2003a, Pagcatipunan, 2003b).

The previous literature does not provide any survey of available technologies preventing occupational risks of confined space work. This section aims to fill such a gap, introducing a review of non-man entry technologies for activities in confined spaces. Specifically, the following technological solutions for safe confined space work are the focus of the Solutions Database Project – Section Confined Space, funded and developed together with AUSL Bologna, Italy. Further information on the aims and the contents of the Project have been introduced in previous Section 2.1.2.1.

#### 3.1.2.1 Methods

The main cause of accidents in confined spaces is the need of entering the high-risk area. The more the workers perform activities outside the confined space, the less the occupational risk of accidents and injuries is. The following survey is the result of the analysis of about a hundred papers and scientific documents concerning innovative technologies for work activities in confined spaces. The research focuses on automated entry technologies for high-risk activities as cleaning, inspecting and maintenance. Included solutions are designed for confined spaces as above and underground storage tanks (AST and UST), ship hulls and tanks in the naval industry, sewers and pipelines. The research question formulated for this study is: “Which automated entry technologies are available for confined space work?”. The research question includes the keywords “confined space work” and “non-man entry technology” for the identification of the publications of interest.

The review involves the screening of Internet resources and electronic (bibliographic) databases of scientific publications published between 1999 and 2015. The screening of the Internet resources verifies the existence of technical reports on the research topics. Such resources include the online databases of international standardization committees and organizations, e.g. the International Organization for Standardization (ISO) and the American National Standards Institute (ANSI), institutes and associations for health and safety at work, e.g. the Italian Workers' Compensation Authority (INAIL) and the European Agency for Safety and Health at Work (EU-OSHA). The screening of the electronic (bibliographic) databases of scientific publications includes the use of keywords and Boolean operators, e.g. AND and OR. Specifically, ScienceDirect, Scopus, Web of Science, Pubmed and EBSCO are among the investigated electronic databases. Further details on the bibliographic resources and the keywords used for literature searches are listed in Table 3.2.

Table 3.2 Bibliographic resources and keywords used in the review process

Resource name	Resource type	Keywords
<i>International committees and organizations</i>		
Italian Workers Compensation Authority (INAIL)	Free statistical database	Confined space accident; confined space injury; fatal accident in confined space.
Italian Organization for Standardization (UNI)	UNI Standards database, authentication required	Confined space; confined space accident; confined space work; confined space work procedure.
European Agency for Safety and Health at Work (EU-OSHA)	Free database of OHS publications	Confined space; confined space accident; confined space work; confined space work procedure.
National Institute for occupational Safety and Health (NIOSH)	Free database of NIOSH publications and products	Confined space; confined space accident; confined space work; confined space work procedure.
Occupational Safety & Health Administration (OSHA)	Free database of OSHA publications	Confined space; confined space accident; confined space work; confined space work procedure.
International Organization for Standardization (ISO)	ISO Standards database, authentication required	Confined space; confined space accident; confined space work; confined space work procedure.
SAI Global	Standards database, authentication required	Confined space; confined space accident; confined space work; confined space work procedure.
American National Standards Institute (ANSI)	Standards database, authentication required	Confined space; confined space accident; confined space work; confined space work procedure.
IHS	Standards database, authentication required	Confined space; confined space accident; confined space work; confined space work procedure.
<i>Bibliographic database</i>		
ScienceDirect – All Content (Elsevier API)	Bibliographic database, authentication required	Non-man entry technology; autonomous robot; confined space work; cleaning; inspecting; maintenance; storage tank; vessel; sewer; pipeline; shipbuilding industry.
Scopus (Elsevier API)	Bibliographic database, authentication required	Non-man entry technology; autonomous robot; confined space work; cleaning; inspecting; maintenance; storage tank; vessel; sewer; pipeline; shipbuilding industry.
Web of Science	Bibliographic database, authentication required	Non-man entry technology; autonomous robot; confined space work; cleaning; inspecting; maintenance; storage tank; vessel; sewer; pipeline; shipbuilding industry.
PubMed	Bibliographic database, authentication required	Non-man entry technology; autonomous robot; confined space work; cleaning; inspecting; maintenance; storage tank; vessel; sewer; pipeline; shipbuilding industry; confined space

Business Premier (EBSCO)	Source	Bibliographic database, authentication required	risk; engulfment; entrapment; asphyxiation. Non-man entry technology; autonomous robot; confined space work; cleaning; inspecting; maintenance; storage tank; vessel; sewer; pipeline; shipbuilding industry.
OAlster (OCLC)		Bibliographic database, authentication required	Non-man entry technology; autonomous robot; confined space work; cleaning; inspecting; maintenance; storage tank; vessel; sewer; pipeline; shipbuilding industry.
Compendex Village 2)	(Ei)	Bibliographic database, authentication required	Non-man entry technology; autonomous robot; confined space work; cleaning; inspecting; maintenance; storage tank; vessel; sewer; pipeline; shipbuilding industry.
IEEE Xplore		Bibliographic database, authentication required	Non-man entry technology; autonomous robot; confined space work; cleaning; inspecting; maintenance; storage tank; vessel; sewer; pipeline; shipbuilding industry.

The following Section 3.1.2.2, 3.1.2.3 and 3.1.2.4 introduce the survey and provide information on available technologies for safe confined space work.

### 3.1.2.2 Automated solutions for cleaning operations in confined spaces

The risk of confined space work is related to the features of the environment and the characteristics of the activity to perform. As an example, workers frequently enter grain silos to dislodge stored material from the walls and perform cleaning operations (Allmaras & McGowan 2005, Strelec 2006, Anroedh & Leslie 2009). These activities expose the workers to high risk of engulfment, suffocation and asphyxiation due to flowing materials and emissions of cleaning substances.

Conventional confined space cleaning procedures are similar for tanks, vessels, sewers and pipelines. After product draining, manual workers typically enter the confined space and physically rinse, wash and sanitize the confined area. These operations are unsafe and expensive (Pagcatipunan 2003a). Compared with manual processes, automated cleaning ensures higher recycling rates, lower sludge volume, higher level of occupational safety and environmental protection, time savings and shorter tank downtime (Bouchagiar 2014). Since workers are not required to enter the confined area, automated technology eliminates the risks of cleaning in confined spaces, e.g. entrapment and asphyxiation, engulfment and exposure to hazardous atmospheric conditions.

#### 3.1.2.2.1 Cleaning solutions for AST and UST

Three cleaning systems have been recently developed for crude oil tanks. The first is a modular tank cleaning system involving the introduction of energy and heat for sludge flushing (Schäfer and Urbach 2015a). Special nozzles spray heated crude oil through the sealed roof into the inertised tank. The second cleaning system is the mobile liquid jet cannon in Figure 3.4 (Schäfer and Urbach 2015b).

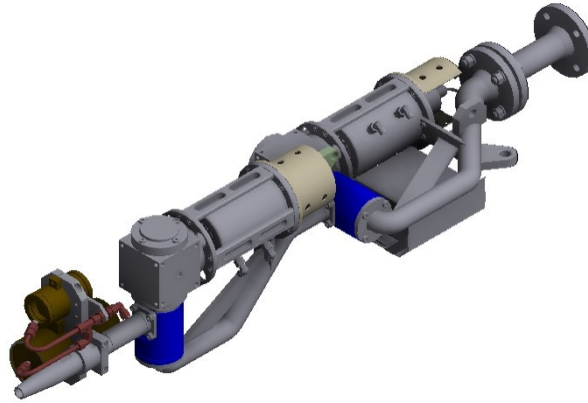

Figure 3.4 Spraying cannon (Schäfer and Urbach 2015b).

The liquid jet cannon consists of a spraying cannon with cleaning nozzle, video camera, headlamp, and supply and operations container (Figure 3.4). Finally, a mobile tank cleaning method has been developed for small, decentralized storage tank (Schäfer and Urbach 2015c).

Similarly, the Robotic Manway Cannon is a cleaning system for oil storage tanks (TechCorr 2015a). The hydraulically controlled cannon performs vapor control and degassing of the tank inner surfaces. The Robotic Manway Cannon can be incorporated with the Track Driven Robotic Unit for sludge handling and removal (TechCorr 2015b). The robot is a remotely operated, hydraulically driven, track-propelled vehicle.

An innovative technology for waste handling and removal is the robotic arm ReTRIEVER for supporting waste removal activity of tanks and silos of the nuclear industry (Glass & Klahn 2011). The system adaptability is enhanced by the possibility to manoeuvre a vacuuming nozzle and further hand tools. The robotic system in Figure 3.5 is SIRO, a silos surface cleaning robot (Dandan, Ananiev & Kalaykov 2013).

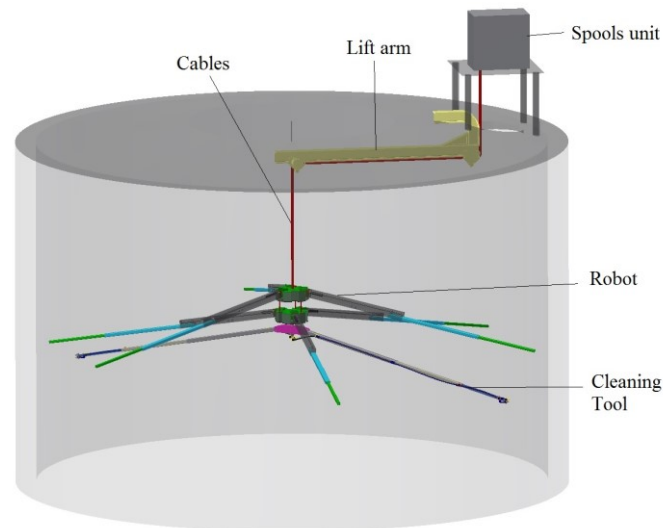

Figure 3.5 SIRO: the silos surface cleaning robot concept (Dandan, Ananiev & Kalaykov 2013).

Designed with a foldable and expandable structure, SIRO enters the silo space in closed pose and starts the cleaning process in opened pose (Figure 3.5).

Besides the main cleaning task, several solutions perform further activities, e.g. inspecting and maintenance operations. Albitar, Ananiev and Kalaykov (2013) introduce a flexible crawling mechanism to design an industrial underwater cleaning and maintenance robot for bio-fouled in-water surfaces. The robot is aimed mainly to clean biofouled underwater surfaces (Albitar, Ananiev and Kalaykov 2013, Albitar, Ananiev and Kalaykov 2014). However, its kinematics allows the execution of further out of water tasks. Compared with cleaning with divers, the speed of the cleaning robot is slightly slower but continuous. An expert is required to set the cleaning parameters and to define the cleaning areas and obstacles. There is no industrial version of this robot. A scaled prototype has been tested in the lab using magnets on metallic surface to prove the concept and the locomotion. The mechanism is simple and the main cost of a commercial version could be for motors and sensors to work in underwater environment. The main limitation of this robotic platform is the inability to move on sharp edges or surfaces with small curvature radius, and parts that are not reachable by the cleaning system. The effect of water movement and hydrodynamics of the robot is not covered by this study considering that cleaning is performed when the speed of surrounding water is low. Finally, the robot is tethered to the base station by power and control cables and hoses. Such connections limit the movement to the length of these connections and add external parameters to be taken into consideration for the stability on the surface.

#### 3.1.2.2.2 Cleaning solutions for ship hulls and tanks in the naval industry

Manual cleaning of mud tanks in the naval industry is a slow and labor-intensive activity, posing health, safety and environmental risks. The economic benefits of automatic cleaning

technology are particularly evident in the deep-water, where the time required to manually clean storage tanks before receiving the new fluid often results in expensive downtime. An innovative tank cleaning system consists of a portable automatic tank cleaning (ATC) unit with pumps, tanks, cones and programmable logic controllers supplying wash solution to the tank cleaning nozzles (Hunter, Liporace & Hamlett 2010). Multiple cleaning machines are placed permanently inside the mud tanks. When cleaning is to take place, a portable ATC unit is brought on-board where the cleaning machines are connected. Compared with regular methods, this system leads to more than 30% of cleaning time reduction and, when needed, confined entry time cuts more than 35%. For hull cleaning and coating removal before ships maintenance, Ortiz et al. (2007) have developed the EFTCoR blasting system. The EFTCoR system performs grit blasting by means of tele-operated devices.

### 3.1.2.2.3 Cleaning solutions for sewers and pipelines

The PCV-1 pipe-cleaning robot is a cleaning device for central air-condition lines (Ye et al. 2010). The robot moves in both vertical and horizontal pipes, enabling the motion in the air conditioning pipe system. This solution allows saving time for cleaning activities in air conditioning pipelines, compared with manual operations. In case of break down, the operator can pull it out through a rope. The robot is a research prototype. The cost of the first prototype was 5000 \$. The adoption of this solution in small and medium enterprises (SMEs) is possible when air pipes are standardized. Mechanical and control engineers are required to operate the robot.

Kovacic et al. (2010) propose a light-weight mobile robot for hydrodynamic treatment of concrete and metal surfaces in sewers and pipelines (Figure 3.6).



Figure 3.6 Light-weight mobile robot for concrete and metal surfaces (Kovacic et al. 2010).

The robot in Figure 3.6 performs a wide-range of operations, e.g. cleaning, repair and maintenance. Modularity and limited weight allow easy transportation and operation in confined spaces. The robot includes a set of ultrasound sensors allowing the automatic

positioning toward the treated surface. The automated entry solution in Figure 3.7 is an effective cleaning and inspecting robot removing solid dregs, rubbles and water-blocks in sewage pipes.

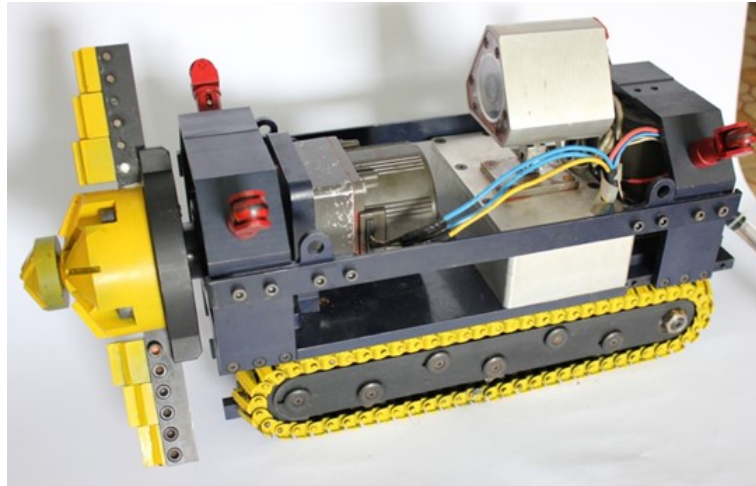

Figure 3.7 Pipe cleaning and inspecting robot (Truong-Thinh, Ngoc-Phuong & Phuoc-Tho 2011).

The cleaning device consists of an electrical-powered roller brush, a cutting plate and a water-jet (Figure 3.7). The device is useful to inspect the situation of the sewers, especially in hazardous environment (Truong-Thinh, Ngoc-Phuong & Phuoc-Tho 2011). In case of breakdown or jam, workers pull the safe cable connected to the robot. The project has been developed in Vietnam and it is a demo version with some limitations. For example, the plan to move is unfeasible in the real environment, due to large capacity of space limitations. Future improvements to this study include the possibility to match the actual environment. Furthermore, the prototype was not expensive and the investment cost of a commercial version could be affordable for SMEs.

Finally, Saenz et al. (2010) have developed a wheel-driven robot for cleaning and inspecting of large concrete pipes. The cleaning tool consists of a telescopic arm with a nozzle bank on its upper end and an ejector nozzle on the lower end. A sensor system inspects above and below the water.

### 3.1.2.3 Automated solutions for inspecting operations in confined spaces

Inspecting operations aim to detect oil leaks, spills, or other potential integrity or structural issues, preventing the failure of the plant and the degradation resulting in slow loss of stored product and possibly contamination of the environment. Inspecting techniques include non-destructive testing (NDT), e.g. ultrasonic testing (UT), acoustic emissions (AE) and visual inspections (VI). After detecting potential integrity or structural issues, crews perform repair and maintenance, and return the tank to service (Summa 2008).



This section introduces innovative non-man entry technologies for automated inspecting of confined spaces as AST and UST, ship hulls and tanks in the naval industry, sewers and pipelines. Thanks to the modularity and the features of several solutions, further applications of such technologies are possible, e.g. cleaning and maintenance. Furthermore, the following solutions allow the workers to inspect the confined area from the outside, eliminating the risks to become trapped or asphyxiated.

#### 3.1.2.3.1 Inspecting solutions for AST and UST

Inspection regulations require leak tests on a regular basis, defined by the industry standards or at a frequency sufficient to prevent discharges. Consequently, companies invest high resources in inspection and maintenance planning, aiming to reduce the tank downtime and to improve the process efficiency.

Inspecting operations for AST include the detection of leakages and defects of the vertical walls and the bottom plate. Conventional non-destructive inspection technology for plate thickness measurement of AST is UT. The robotic inTANK® inspection system provides high-density ultrasonic thickness scanning of the floor, while the tank is full and in-service (Summa 2008). The robotic inspection tool reports top and bottom-side corrosion locations, floor-plate thickness and pitting, videotape of roof underside, and coating measurement. The Short Range Guided Wave Ultrasonic Technique is adopted to test the annular plate of in-service AST. A transducer is placed on the chime plate propagating long-range ultrasonic waves into the annular plate. When corrosion or pitting is present, the surface reflects the sound and the system provides a scan image of the defect (TechCorr 2015c).

Sakamoto et al. (2013) propose an improved AE testing method for detecting corrosion rate in tank bottom plates. Two sets of AE sensors are positioned on the side surface and annular plate at regular intervals, depending on the size of the tank. The method facilitates noise removal, improving the location accuracy of the origin of corrosion.

Typically, automated entry technologies for tank inspection use a remote controlled device tethered via an umbilical to a control and monitoring system. The robot descends to the tank bottom while the tank is in-service and navigates across its floor using a system capable of mapping locations where data are collected. The benefits of the robotic process include reduced project planning, as the tank is in-service during the inspection process, and reduced safety and environmental risks. Furthermore, robotic inspecting eliminates downtime costs, maximizing the lifecycle and reliability of the tank. The Camaleonte, Ragno, Bruco and Fury robots are innovative technologies for inspecting operations in underground tanks. Camaleonte performs thickness measuring, cleaning and sand blasting (Petroltecnica 2015a). Ragno is a remote controlled robot for wall thickness measuring through ultrasound method (Petroltecnica 2015b). Bruco is a small tracked inspecting and cleaning robot for underground tanks (Petroltecnica 2015c). Fury is a robotic crawler for tanks inspection with ultrasonic transducers for wall thickness measurements (Marsh et al. 2004).

VI is the oldest NDT method for inspecting the contents of a confined space or detecting the surface discontinuities. Remote VI methods for confined spaces aim to acquire visual data of the internal environment avoiding the need for personnel to enter the confined area. Telemax remote operated vehicle (ROV) conducts VI of accelerator complex radioactive areas (Kershaw et al. 2007). This tracked robot includes a manipulator arm for remote manipulation of loads and dedicated tools for radiation monitoring.

Nuclear power companies widely employ climbing robots for inspecting operations due to safety issues and requirements concerning the nuclear industry. The use of such technologies is limited in conventional power generation industry (Bogue 2010). The mobile robotic system (MRS) series robots move on complex-shaped surfaces, handling obstacles and climbing over steps and edges. The Magnebike climbing robot in Figure 3.8 is a magnetic wheeled device for steel structure inspection (Tâche et al. 2009).

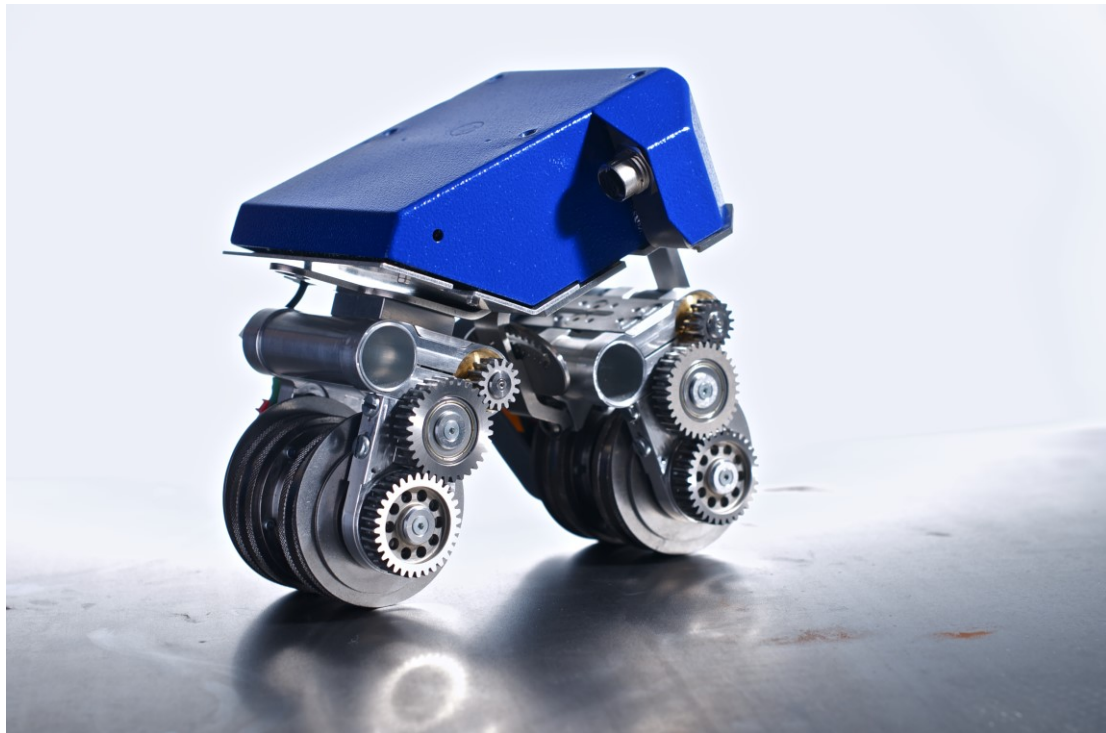

Figure 3.8 Magnebike, magnetic wheeled inspection robot (Tâche et al. 2009).

Magnebike climbs vertical walls and follows circumferential paths inside tanks and pipe structures, overcoming ferromagnetic obstacles (Figure 3.8). Similarly, Weimin, Gu, and Yanjun (2005) propose two wall-climbing robots with permanent magnetic tracks for inspecting oil tanks and power stations.

NERO (Nuclear Electric Robot Operator) and SADIE (Sizewell A Duct Inspection Equipment) are two climbing robots for the inspection of reactors through NDT (Figure 3.9 and Figure 3.10).

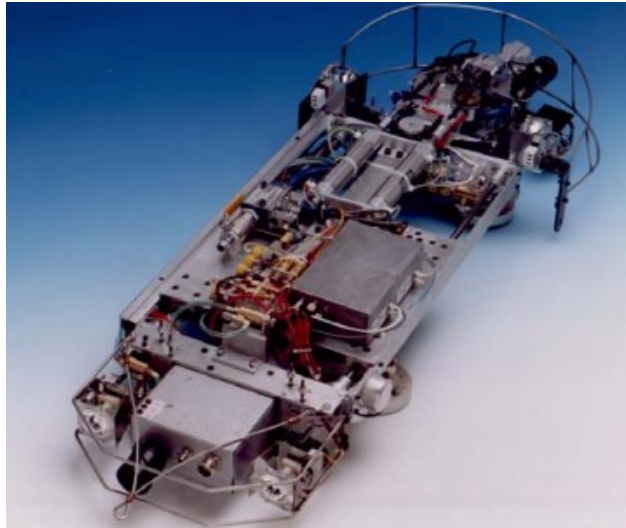

Figure 3.9 NERO Nuclear Electric Robot Operator Series (Luk et al. 2006).

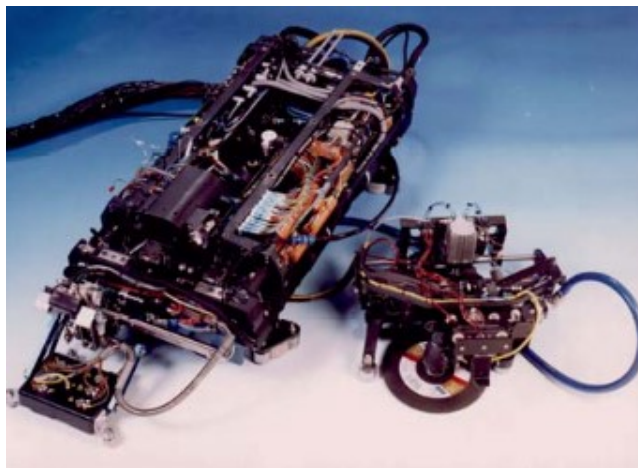

Figure 3.10 SADIE Sizewell A Duct Inspection Equipment Series (Luk et al. 2006).

NERO is a pneumatically driven non-articulated legged vehicle, which is able to step over small obstacles and to crawl under low overhangs (Figure 3.9). SADIE is provided with an inspection tool which could carry the ultrasonic transducers (Figure 3.10). Both these robots have been applied successfully for remote inspection and maintenance applications.

Further tools for the inspection of hazardous environments as nuclear reactor pressure vessels include long reach manipulators. The Robotic Tank Inspection End Effector (RTIEE) has been designed for remote operations in hazardous waste UST (Idaho National Engineering and Environmental Laboratory 2000). The robotic system combines alternating current field measurement with a compact vision and lighting subsystem and an integrated mechanical deployment subsystem. For the inspection of hazardous inaccessible areas in nuclear power plants, Savall, Avello and Briones (1999) propose Robicen III and MonoCabRob robots. Robicen III is a compact pneumatic climbing robot for the inspection of radioactive cylindrical tanks. Based on a mono-rail locomotive system,

MonoCaRob is designed to travel through narrow passageways between pipes, valves and supports inside the drywell. These two robots are laboratory prototypes developed in research projects. Unfortunately, there is no information on their application in industry.

While Robicen III and MonoCabRob are primarily designed for the nuclear industry, the wall-climbing robot Alicia<sup>3</sup> inspects the external surface of petrochemical AST (Longo & Muscato 2004). Alicia<sup>3</sup> uses pneumatic adhesion and has a suitable payload to carry mission-specific equipment.

### 3.1.2.3.2 Inspecting solutions for ship hulls and tanks in the naval industry

The activities to prepare a tank for human entry and inspection involve certifying the tank safe for human entry, cleaning the tank and installing scaffolding for the inspection. The US Naval Research Laboratory adopts the use of Corrosion Sensor based Tank Monitoring Systems (CSTMS) and the Insertable Stalk Inspection System (ISIS) for monitoring and documenting the confined space conditions (Nelson et al. 2012). Specifically, CSTMS consist of permanently installed components both inside and outside the tank for the detection of possible corrosions. The ISIS performs a visual inspection of the confined space with a high quality camera.

Shang et al. (2008) propose the robotic system in Figure 8 for marine welding inspection.

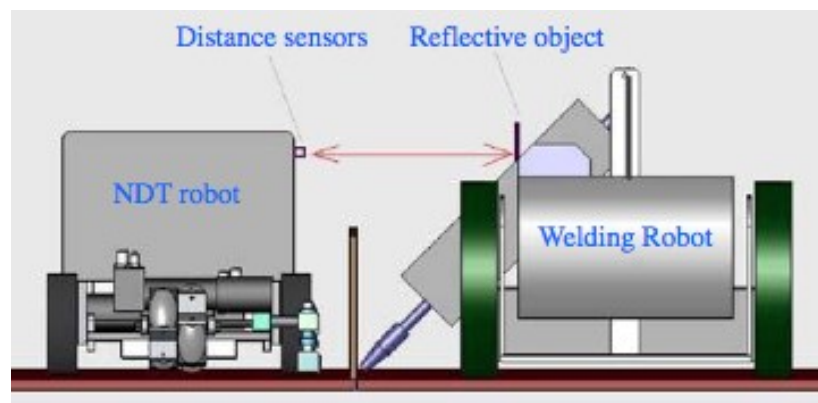

Figure 3.11 NDT climbing robot for inspection of long weld lines (Shang et al. 2008).

This climbing robot performs the real time VI of long weld lines simultaneously with the welding process (Figure 3.11). Sánchez, Vázquez and Paz (2006) propose a versatile lightweight climbing robot with permanent magnets for naval construction. Typically, a crane or a safety rope secures the magnetic climbing robots in case of slipping or fall. To avoid the use of safety precautions and facilitate the robot mobility, Eich and Vogele propose the lightweight crawler in Figure 3.12 (Eich & Vogele 2011, Eich et al. 2014).



Figure 3.12 Lightweight magnetic climbing robot (Eich & Vogele 2011).

After VI, the lightweight crawler marks defects on the surface of the ship, by means of a micropump and acrylic varnish (Figure 3.12). Further robots for marine inspection services are the Steel-Climber and the Magnet Crawler M250 (Miko 2013, Jetstream 2013). Both the robots are heavyweight magnetic crawlers for blasting, cleaning and inspection. Heavyweight crawlers sustain heavy equipment and tools for NDT and accurate inspections. The heavyweight Magnetic Autonomous Robotic Crawler (MARC) includes an electrical robotic arm and an ultrasound probe for non-destructive thickness measurement, together with several sensors and devices (Bibuli et al. 2012). Finally, aerial platforms, e.g. the Pelican Quadrator from Ascending Technologies, are employed to inspect hazardous environments that are difficult to reach (Eich et al. 2014).

#### 3.1.2.3.3 Inspecting solutions for sewers and pipelines

Conventional methods for sewer pipe inspection adopt not autonomous cable-tethered robots with an on-board video camera system. The human operator tele-operates these robots, while watching the sensor data as the robot inspects the pipe. The current literature proposes several semi-autonomous robots for pipe inspection, e.g. KARO and PIRAT for the quantitative and automatic assessment of the sewer condition, or the Pearl Rover robot for in-water inspections (Kuntze et al. 1995, Kirkham 2000, Bradbeer et al. 2005). Un-tethered robots perform fully autonomous inspections of sewers and pipelines carrying all required equipment on-board, e.g. KURT, MAKRO and KANTARO (Kirchner & Hertzberg 1997, Rome et al. 1999, Nassirei et al. 2007, Granosik 2014). For inspecting and monitoring underground energy lines, Estrada, Silveira, Gonçalves, Filho, De Oliveira and Botelho (2010) propose the autonomous robotic platform. The platform is provided with sensory equipment for navigation, such as inertial sensors, ultrasonic sensors, odometers and cameras.

The Fraunhofer Institute for Factory Operation and Automation has developed and built prototypes of fully automatic inspection and cleaning systems for sewers and pipelines (Elkman et al. 2007, Walter et al. 2012). A swimming robot, Spy, performs a preliminary inspection, recording erosion, deposits, obstacles and leaks in the gas space. The wheel-

driven cleaning system eliminates the detected deposits and cleans the sewer wall for the secondary inspection. Compared to other available technologies, such robots can deliver numerous inspection data and high quality results. Typically, the pressure loss in the water hose supplying the nozzles is the limiting factor, and typical cleaning lengths are between 80-200 m. The cleaning robot, which uses high-pressure water to clean the inside of the pipe wall, is able to clean long stretches of up to 1200 m. Spy is able to create a high-resolution image of the pipe interior, allowing the detection of cracks with a width of minimum 0,5 mm. The robots have been designed so that they can be recovered without the need to send workers into the sewer, i.e. all the devices are tethered. Workers should be provided with proper training on the system operation and working knowledge of computers prior to operate the system. Furthermore, skilled personnel as sewer inspectors are needed to supervise the robots and to analyze the inspection results. No information about the cost of the system and the time saved are available. The main limitations of this solution are due to the specific design for the German sewer system.

Finally, Singh, Verma and Shrivastava. (2008) propose robotic sewer inspection equipment controlled by embedded systems. Specifically, the embedded system locates the blockage and ultrasound sensors analyze the type of blockage.

The previous robotic systems are adopted for the inspection of piggable sewers and pipelines. The current literature proposes the use of different robotic systems for the inspection of unpiggable above ground pipelines. For example, the Robotic Pipe Scanner (RPS) by Rosen Swiss AG moves along the outside of the pipe for the inspection of the pipeline conditions. The robot uses the magnetic flux leakage technique to detect defects such as pinholes, pitting and other metal loss due to corrosion or erosion (Bogue 2010).

#### 3.1.2.4 Automated solutions for maintenance operations in confined spaces

Reduced visibility, restricted access, and potentially low oxygen levels are critical characteristics of confined spaces that make maintenance activities demanding and dangerous.

The following non-man entry technologies for confined space work allow the workers to perform maintenance tasks remaining outside the confined area. Consequently, the risks of maintenance activities for workers in confined spaces (e.g. electrocution and hazardous atmospheric conditions) disappear when such solutions are adopted.

##### 3.1.2.4.1 Automated maintenance in AST and UST

The Autonomous Maintenance Robot (AMR) in Figure 3.13 is a flexible robotic system for semi-autonomous operation and remote tele-operation in confined spaces (Krasny 2012).





Figure 3.13 Autonomous Maintenance Robot AMR (Krasny 2012).

After scanning the environment, AMR moves semi-autonomously within a confined space, avoiding collisions with the environment (Figure 3.13). For maintenance and repair operations, e.g. coating removal and welding, the robot is equipped with specific tools.

High-rise tasks such as maintenance on walls of large tanks require robots with climbing and manipulating skills. The Wall-Climbing Robot (WCR) and the W-Climbot are automated entry technologies for high-rise maintenance tasks. Specifically, the WCR uses magnetic tracks for self-moving during labeling scale of oil tank's volume (Xu & Ma 2002). W-Climbot is a mobile manipulator using dual suction modules at the two ends as adhesive tools and end-effectors (Guan et al. 2013).

The Manipulator Arm and the robot arm AARM are examples of remote controlled manipulators for maintenance operations in the nuclear industry. The Manipulator Arm is a robotic arm integrated on confined space mobile platform performing variety of tasks in limited workspace (Pathak, Singh & Bansal 2013). AARM is a remote controlled robotic arm for nuclear reactions retrofit operation (Goldenberg, Gryniewski & Campbell 2010, Zhu et al. 2015). The operation of AARM is similar to current industrial manipulators. The cost of the device is comparable with a general 6-D industrial manipulator (about 30,000 – 45,000 \$). The robot has not been adopted in industry yet. The designers have not tested non-failure operation time and the system reliability. Limitations of the AARM include the need to enter the confined space in case of system breakdown and the presence of the power cable, i.e. the developers are studying an off-the-shelf battery solution with enough high-power density for power supply.

#### 3.1.2.4.2 Automated maintenance in ship hulls and tanks in the naval industry

Current robotic systems struggle to accomplish specific industrial applications, especially those requiring high mobility in complex environments, e.g. ship hulls and shipyards. The working conditions of naval construction workers are difficult. Manual operators weld in closed cells with poor ventilation and thick fumes (Aneziris, Papazoglou & Kallianiotis 2010). The ROWER robot in Figure 3.14 is a lightweight remote controlled welding system for ship erection and maintenance processes.

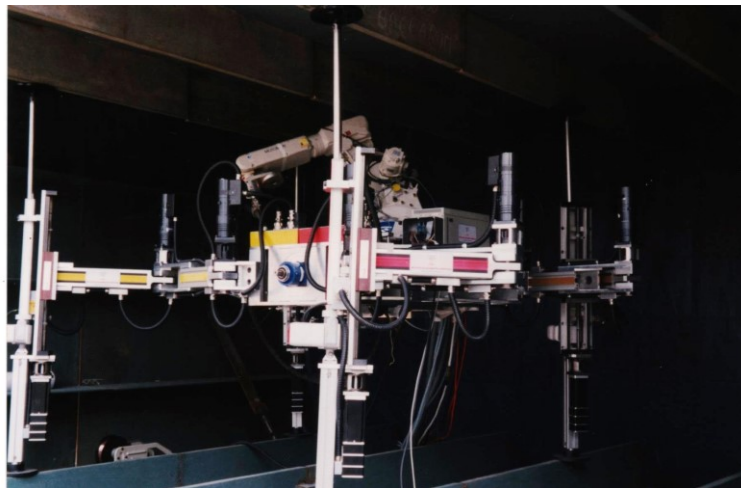

Figure 3.14 ROWER (Gonzales De Santos, Armada, Jimenez 2000).

ROWER consists of a four-legged mobile platform and a stereo vision system for the detection of the extremities of the welding seam (Figure 3.14).

Stripping coatings and corrosion from large ships is a typical labor-intensive maintenance task in naval industry. The M2000 robot automatically removes paint from ships using ultrahigh pressure water jets (Ross, Bares & Fromme 2003). Souto, Faiña, Deibe, Lopez-Peña and Duro (2012) propose a robot with magnetic legs for automatic grit-blasting of ship hulls. The robots reduce the environmental impact of grit-blasting operations and the health risk for manual operators.

#### 3.1.2.4.3 Automated maintenance in sewers and pipelines

Sewer and pipeline maintenance aims to repair erosion, corrosion and other defects. Typical procedures include no-dig cured-in-place pipe (CIPP) technologies. The method consists in the application of a resin-saturated tube into the damaged pipe. The Point Liner System adopts the same principal for the localized rehabilitation of damaged pipelines (Foreverpipe 2015). After the exact localization of the damaged area by means of a remote controlled robot, an impregnated material is compressed against the pipe wall by inflation of a bladder. The bladder is then deflated and removed, while the cured pipe wall is smooth and free from damages.



### 3.1.2.5 Discussion

The introduced review of non-man entry technologies for confined space work shows several automated solutions for typical hazardous confined space activities, i.e. cleaning, inspecting and maintenance. The following Table 3.3 shows the classification of the presented automated technologies depending on the confined space type and activity.

Table 3.3 Classification of automated entry technologies for confined space work depending on confined space type and activity.

<i>Type of confined space</i>	<i>Cleaning</i>	<i>Inspecting</i>	<i>Maintenance</i>	<i>Total</i>
AST and UST	8	17	5	30
Ship hulls and tanks in the naval industry	2	8	3	13
Sewers and pipelines	4	11	1	16
<b>Total</b>	<b>14</b>	<b>36</b>	<b>9</b>	<b>59</b>
<i>Type of confined space</i>	<i>Scientific papers</i>	<i>Conference papers</i>	<i>Other</i>	<i>Total</i>
AST and UST	7	12	11	30
Ship hulls and tanks in the naval industry	6	6	1	13
Sewers and pipelines	5	10	1	16
<b>Total</b>	<b>18</b>	<b>28</b>	<b>13</b>	<b>59</b>

Specifically, screened literature includes scientific papers from international journals, scientific contributions to conferences and other documents (e.g. reports, book chapters and web contents). More than the 77% of the screened documents are from international journals and conference proceedings, divided between scientific papers (31%) and scientific contributions to conferences (47%). Numerous technologies for operations in tanks are commercialized and many companies offer tank cleaning and inspecting services with non-man entry technologies.

The review shows that more than 50% of recent solutions for automated entry confined space work are designed for storage tanks (Table 3.3). Specifically, automated technologies for inspecting represent more than the 57% of solutions for storage tanks and more than the 60% of the overall solutions of this review.

The following Table 3.4 introduces the classification of non-man entry technologies for each confined space type, depending on the ability to perform multiple tasks.

Table 3.4 Classification of automated entry technologies depending on the ability to perform multiple tasks

<i>Main task</i>	<i>Secondary task</i>		
	<i>Cleaning</i>	<i>Inspecting</i>	<i>Maintenance</i>
<i>Above ground and underground storage tanks</i>			
Cleaning	-	4	1
Inspecting	2	-	4
Maintenance	0	2	-
<i>Ship hulls and tanks in the naval industry</i>			
Cleaning	-	0	0
Inspecting	0	-	0
Maintenance	0	0	-
<i>Sewers and pipelines</i>			
Cleaning	-	2	1

Inspecting	1	-	0
Maintenance	0	1	-

The introduced review reveals that several automated entry technologies perform multiple tasks. Thirteen (43%) solutions for storage tanks perform multiple tasks, e.g. inspecting/cleaning and inspecting/maintenance. Conversely, the reviewed solutions for ship hulls and tanks in the naval industry perform a singular task. Finally, none of the reviewed solutions perform cleaning, inspecting and maintenance tasks.

A consistent part of the introduced solutions for confined space work are prototypes of research. Limitations of such solutions are due to their controlled application in research laboratories. Industrial applications are limited and little information on the reliability and the cost of such solutions are available. Other devices are designed for specific applications and their adoption in industry is limited by stiff operational parameters and pre-defined features of the environment. However, researchers and developers of the introduced solutions assume that the expertise required to use the robots is moderate and conventional time for workers' training is enough.

The choice to replace human work with autonomous technologies is not obvious. Automated non-man entry technologies use remote techniques reducing personnel confined space entries. Benefits of automated confined space work are not limited to higher level of occupational safety. Automated methods achieve better performances in shorter time, offering lower downtime costs and higher efficiency (Pagcatipunan 2003).

SMEs carefully analyze the pros and cons of robots for automated confined space work in order to ensure the return of the high investments on such technologies. However, the cost of non-safety due to the lack of safety equipment and solutions is higher than the cost for their investment. In particular, occupational accidents cause direct costs and indirect costs to the companies (Botti, Mora & Regattieri 2015). The former include quantifiable costs due to the accident event, e.g. workers' compensation payments, medical expenses, and costs for legal services etc. The latter are frequently underestimated and include lost productivity, recruitment and training of new employees, costs associated with lower employee morale and absenteeism. Furthermore, industrial accidents in confined spaces frequently result in fatalities and permanently disabling injuries. Consequently, the high risk of confined space work should tip the balance in favour of automation technology.

The following section discusses the results and provides directions for future research on automated entry solutions for confined space work.

### 3.1.2.6 Conclusions and considerations on available engineering controls for safe confined space work

Confined space work poses a significant risk to both workers and rescuers involved in the emergency response when an accident occurs. Removing the hazard is possible by avoiding

the man entry, but many activities require the presence of the worker inside the confined space to perform manual tasks. Typical high-risk confined space activities include cleaning, inspecting and maintenance tasks. This Section provides a systematic review of innovative solutions for hazardous confined space work activities, considering automated entry as the most effective confined space safety program. The classification of automated entry technologies for confined space work depending on confined space type and activity shows that several solutions are available for activities in AST and UST (see in Table 3.3). Several non-man entry technologies are designed for inspecting tasks (61%), while further research is needed for confined space repair and maintenance solutions (see in Table 3.3 and Table 3.4). Despite several automated entry technologies perform multiple activities, none of the reviewed solutions accomplishes cleaning, inspecting and maintenance tasks. Specifically, practice shows that confined space inspection and restoration are performed after cleaning operations. Consequently, further research on multiple-purpose automated entry technologies is needed. Finally, automated technologies require to be safely operated by trained and certified operating personnel, reducing the risk of human error.

## 3.2 ADMINISTRATIVE CONTROLS FOR CONFINED SPACE WORK

### 3.2.1 IOT for occupational safety

This section introduces two novel administrative controls for the reduction of the risk of activities in confined spaces. Specifically, both the following control methods investigate the adoption of IOT technology for managing the risks of confined spaces.

IOT technology mainly refers to a paradigm where objects and people are interconnected and share information between each other and with the environment. Based on definition proposed by Sun et al (2012) and Borgia (2014), an IOT technology-based system is composed by three main pillars: the first capability characterizing an IOT technology-based system is provided from the collection phase where the sensor layer allow to acquire information from other objects and/or the environment. Next, the transmission phase provided by the network layer communicates knowledge previously acquired. Finally, processing and utilization phases are developed through an application layer which manages and interprets knowledge and data for final users. This parallelism which overlaps technological with process based point of view is depicted in Figure 3.15.

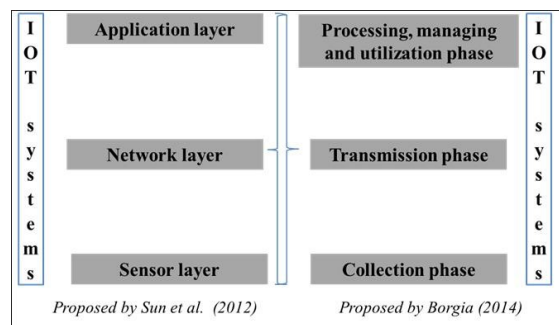

Figure 3.15 General structure of an IOT technology-based system.

According to a technological point of view, the most widespread technologies in the collection phase/sensor layer are RFID (Radio Frequency Identification), Wireless Sensor Networks (WSN) and NFC (Near Field communication).

RFID technology has becoming widely applied in the industry sector for identifying and tracking objects and people. RFID mainly consists of a tag, which is attached to the item, and a reader, which acquires data from the tag for exchanging with communication layers (other devices, Internet, etc.). Different tag types could be used: passive (without a battery) and active (equipped with a battery) tags could provide different features based on the specific

field of application. WSN is composed by a large number of sensors able to acquire, transmit and process data from an external environment. NFC is a proximity technology allowing communication process between devices by touching each other.

The transmission phase/network layer consists of tools, which transfer collected information to applications or external servers. Main tools used in a IOT technology-based system are Ethernet, WIFI and WiMax services; mobile communication which includes cellular as well as satellite technologies, and PLC (Power Line communications) that applies the electrical power system as a transmission medium.

Finally, in the processing phase/application layer, information flows are processed and analyzed; feedback controls could be sent to specific devices. Technologies at this phase are mainly oriented on software tool allowing managing data and extracting effective knowledge from them.

#### 3.2.1.1 Brief state of the art analysis about the application of IOT technology for risk prevention and reduction in hazardous workplace

IOT technologies are becoming widespread in our society in several industrial and service sectors (Atzori et al. 2010; Elia and Gnoni, 2013). Typically, an IOT application is based on three main categories of components (Borgia, 2014): collection devices, communication systems, and analysis applications. This structure represents the most innovative feature of an IOT technology-based system compared to a single ICT technology: IOT technology-based systems are capable to acquire, communicate and, more relevant, to analyze and provide effective feedbacks to their users. This capability will allow to widespread the application of these technologies in different field of application: one most promising is the risk prevention and control in hazardous workplace. Thus, an increasing, but still low compared to other fields, number of applications could be outlined in the scientific literature about the adoption of IOT technologies for supporting risk prevention and control in confined spaces. One main field of adoption is to support *emergency response activities* after an accident. Gelenbe and Wu (2013), Yang et al. (2013), Li et al. (2014a and 2014b) discussed potential impacts of IOT technologies for supporting emergency response operations to provide more efficient cooperation, to increase situational awareness of rescues and, finally, to provide complete visibility of resources during the emergency event. Qiuping et al. (2011) discussed main criticalities concerning the design of an IOT technology prototypal system to support safety and emergency management in mine sites. Two main topics have been discussed: main issues regarding the transmission phase, as it has to be developed in an harsh environment, and the actual compatibility of this technology with the working area, as wireless devices could contribute to increase risk levels (e.g. fire and/or explosion hazards). Liu and Zhu (2014) critically discussed the use of IOT technologies for supporting a specific emergency event, i.e. fire emergency operations. Another field of IOT technology application is on risk control and supervision in confined space. Yinghua et al. (2012) discussed the capability of IOT technologies to support safety supervision in a coalmine industry. Sun et al.

(2012) described an IOT technology prototypical system for tailings dam monitoring and for pre-alerting workers.

Recent pilot projects have applied IOT technologies for supporting safety management in complex contexts. Kim & Kim (2012) and Ruz et al. (2012) proposed a warning system that signals to operators the proximity danger to machines with high risk based on RFID technology. Qiuping et al. (2011) proposed an IOT technology-based platform to support safety and emergency management in mine sites. As the transmission phase has to be developed in an harsh environment, devices placed underground could transfer data via wireless technology: one problem outlined is the compatibility of this technology in the working area as wireless devices could contribute to increase fire and/or explosion hazards. Another possible application is to alert workers and safety managers about hazardous conditions that will occur in the workplace. Riaz et al. (2014) described a prototype system based on IOT technologies for providing alert to safety managers about temperature and oxygen concentration in construction sites where confined space risk is high. The system applies wireless sensor network to acquire data from the construction site and manage alarms to workers in specific areas.

The following Section 3.2.2 introduces the proposed framework for analysing risks and work procedures in confined spaces. The framework supports safety managers and risk analysts in reducing hazards in confined spaces. The aim is to address safety specialists during the analysis of the dangerous scenario in confined spaces, defining the impact of IOT technologies for preventing and managing confined space risks.

### 3.2.2 Framework for preventing and managing risks in confined spaces

This section conceptualizes a procedure that will address the design of the framework for the prevention and management of confined spaces risks. The procedure collects the concepts and requirements from the fragmented regulations for safe confined space work (Figure 3.16). The aim is to provide a reliable tool for the analysis of the dangerous scenario in confined spaces (Botti et al. 2015). Firstly, the procedure proposes the analysis of the characteristics of the confined area, the characteristics of the task and the requirements of the emergency response plan. Secondly, the framework investigates the risks of the confined space work. The risk assessment includes the analysis of both the causes and the consequences of the activities performed within the confined area. Finally, the procedure terminates with the analysis of the engineering and administrative controls for risk elimination or reduction.

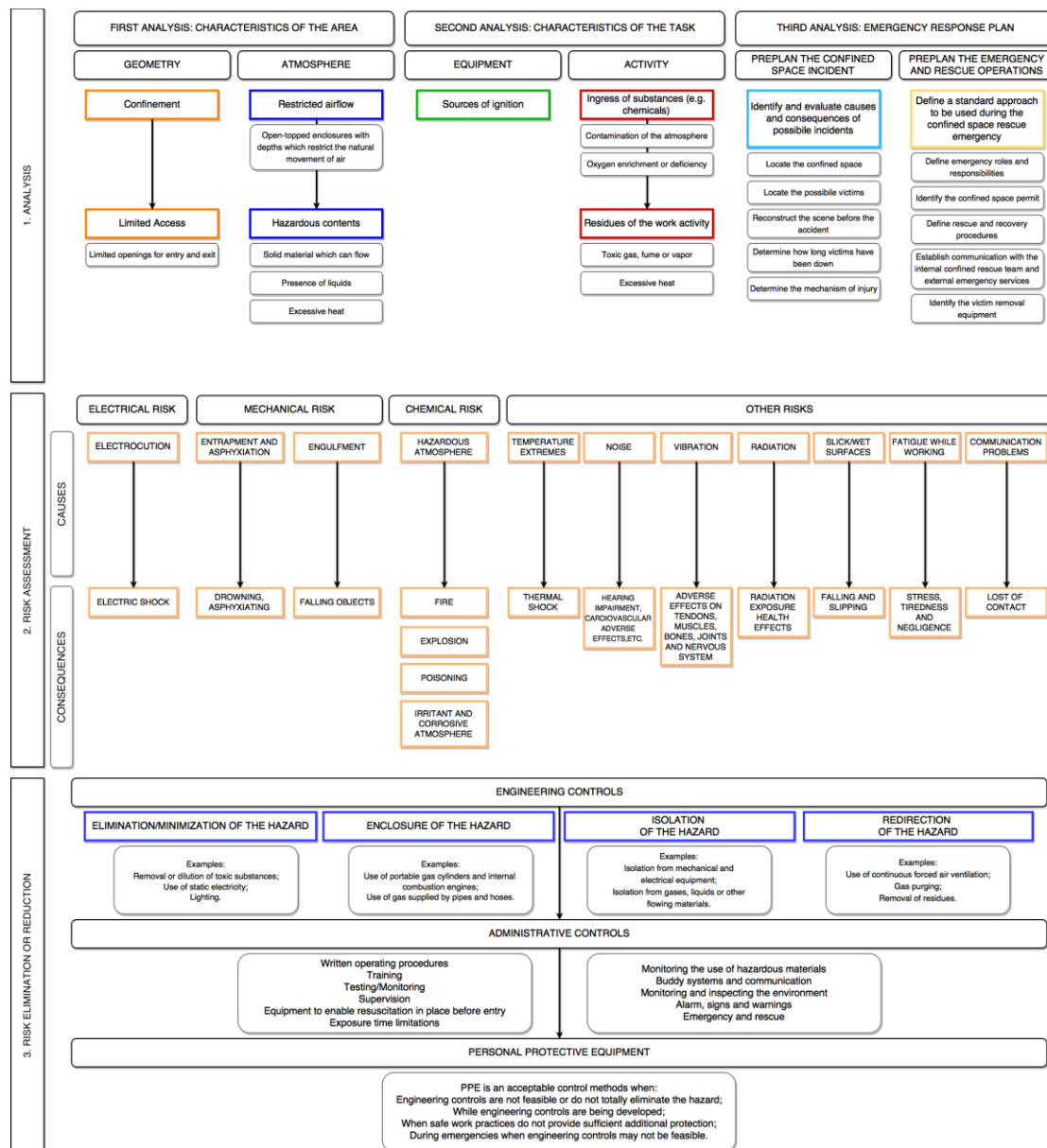

Figure 3.16 The procedure for the prevention and management of confined spaces risks.

### Phase 1: Analysis.

The first step of the procedure guides safety specialists and practitioners through the analysis of the confined space characteristics. The analysis investigates the characteristics of the confined space, the characteristics of the task and the requirements for safe emergency response in case of accident. The first analysis includes the analysis of the characteristics of the confined space. Both the geometric characteristics and the atmospheric characteristics of the confined space affect the safety conditions of the confined area. Particularly, confined spaces are restricted areas with limited openings for entry and exit. As a consequence, the airflow is restricted and the hazardous contents may determine atmospheric conditions immediately dangerous to life or health (OSHA 1993). The second analysis investigates the



characteristics of the task performed in the confined space. Both the adopted equipment and the performed activity may affect the atmospheric conditions of the confined area and contaminate the atmosphere. Finally, the third analysis includes the study of the requirements for safe emergency and rescue operations. The emergency response plan analysis aims to ensure high performances of both the emergency response plan and the emergency and rescue procedure, in case of accident in the confined area. Particularly, the preplan of the confined space incident helps emergency response team in identifying the causes and the consequences of possible incidents. The analysis of emergency and response plan concludes with the preplan of the emergency and rescue operations. The aim is to identify an effective approach to be used during confined space rescue operations. This phase involves the design of a standard emergency and rescue procedure and the phases from the request for emergency response to the termination of the emergency intervention (Hansen 1999).

### *Phase 2: Risk assessment*

The second step of the procedure analyses the multiple risks of confined space work. The aim is to identify the leading causes of confined space incidents and the possible hazards of work in such hazardous workplaces. Three main types of risk characterize confined spaces: electrical, mechanical and chemical risk. Electric shock injuries and deaths are frequent consequence of electrocution in confined spaces. Mechanical risks include the risk of entrapment, asphyxiation and engulfment due to drowning or falling objects. Finally, hazardous atmospheric conditions lead to fire, explosion, poisoning and other hazardous consequences of the chemical risk in confined spaces. Other possible risks of work activity in confined spaces include temperature extremes, noise, vibration and communication problems (Figure 3.16).

### *Phase 3: Risk elimination or reduction*

The information obtained from the hazard analysis in Phase 1 and the risk assessment in Phase 2 allow to identify the control measures for risk prevention. The aim of Phase 2 is to define the control methods to eliminate or reduce the hazards identified in the first to phases of the framework. The most effective control methods are engineering controls, which physically change the characteristics of the work activity to prevent workers exposure to the identified hazards (OSHA 2002). Such controls include the use of static electricity for the elimination of the hazard or the use of continuous forced air ventilation for the redirection of the hazard. Engineering controls for the elimination of the hazard are preferred control methods, rather than engineering controls for the minimization, enclosure, isolation or redirection of the hazard. If engineering controls are not feasible, administrative controls may be appropriate. Such controls involve operating procedures or organizational methods, e.g. written operating procedures, safe work practices and training. Finally, PPE is an acceptable

control method if engineering controls are not feasible or when administrative controls do not provide adequate additional protection. Safety plans and procedures may include engineering control methods rather than administrative controls or PPE, aiming to provide protection and to abate the hazards in confined spaces. If engineering controls can not eliminate the hazard, the optimal control measure is a combination of all three methods.

#### 3.2.2.1 The structure of the framework

The following Figure 3.17 is based on the previous procedure in Figure 3.16 and introduces the final framework with the stepwise approach addressing the choice of suitable IOT technologies for safe confined space work.

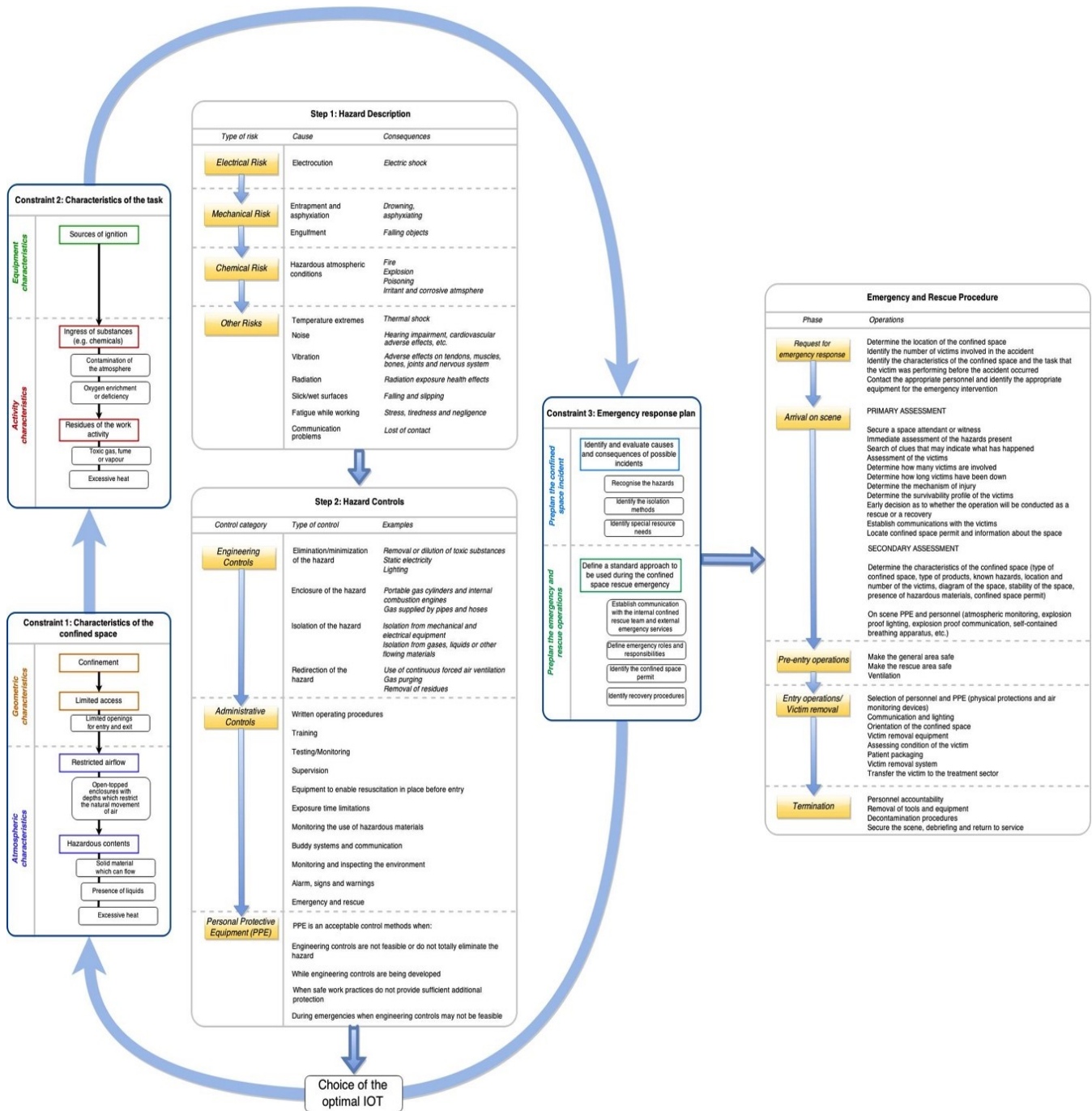

Figure 3.17 The proposed framework.

The stepwise approach in Figure 3.17 addresses safety managers and risk analysts during the choice of suitable IOT technologies preventing and managing confined space risks.

### Step 1: Hazard description

The first step of the framework analyses the multiple hazards in confined spaces. The aim is to identify all the possible risks of work in confined spaces that can be the leading cause of incidents and injuries in such hazardous workplaces. Three main types of risk characterize confined spaces: electrical, mechanical and chemical risk. Electric shock injuries and deaths are frequent consequence of electrocution in confined spaces. Mechanical risks include the

risk of entrapment, asphyxiation and engulfment due to drowning or falling objects. Finally, hazardous atmospheric conditions lead to fire, explosion, poisoning and other hazardous consequences of the chemical risk in confined spaces. Other possible risks of work activity in confined spaces include temperature extremes, noise, vibration and communication problems.

#### *Step 2: Hazard controls*

The information obtained in Step 1 from the hazard analysis is useful to identify the hazard control measures preventing the recognized risks. The aim of Step 2 is to define the control methods to eliminate or reduce the hazards identified in Step 1, following the hierarchy of controls in previous Chapter 2 (Figure 2.2).

#### *Constraint 1: Characteristics of the confined space*

The first constraint includes the analysis of the characteristics of the confined space. Both the geometric characteristics and the atmospheric characteristics of the confined space affect the impact of the IOT technologies for preventing and managing the identified risks.

#### *Constraint 2: Characteristics of the task*

The characteristics of the task performed in the confined space have a direct impact on safety conditions of the confined space. Both the adopted equipment and the performed activity may affect the atmospheric conditions of the confined area and contaminate the atmosphere. Such characteristics condition the impact of the IOT technologies.

#### *Constraint 3: Emergency response plan*

In case of emergency, IOT technologies provide useful information on the confined space characteristics for improving the performance of both the emergency response plan and the emergency and rescue procedure.

#### 3.2.2.2 Impact analysis of IOT technologies for confined spaces

The main contribution of IOT technologies for preventing and managing risks in confined space could be oriented to improve the information flow between all actors involved. Three main categories of actors could be outlined: safety managers, which usually prepare the preliminary assessment phase required when a task in a confined space is planned, operators which will carry out the task, and rescue teams. IOT technology-based systems could be used to interconnect in a reliable and dynamic way all these actors with the workplace.

Potential contributions of IOT technology-based system have been evaluated by adopting the framework proposed in the previous section: based on a qualitative scale (from Low to High value), contribution has been evaluated and results are in Figure 3.17.

Framework module		Estimated Impact	Description
Step 1- Hazard Description		LOW	The contribution of IOT systems could be oriented to update data about actual conditions of the working environment which could influence the risk assessment process.
Step 2- Hazard Control	Engineering controls	VERY HIGH	IOT system (especially Sensor network or RFID based device) could be applied to “certificate” the actual condition of the hazard evaluated in the previous step.
	Administrative controls	LOW	IOT could contribute to provide real time information during the execution of the task
	Personal Protective Equipment	HIGH	IOT capability of acquiring data in different ways (e.g. by a wearable sensor connected via RFID or NFC) could be used to “amplify” traditional features of a PPE. The PPE could be transformed in a smart object equipped with increased functionalities.
Constraint 1	Confinement	HIGH	RFID technology could be applied to “certificate” the activity in a more reliable and automatic way.
	Limited Access	HIGH	RFID and NFC technology could be easily used to automate the access management process aiming to provide real time information about this issue.
	Restricted airflow	MEDIUM	IOT systems could be applied to develop condition based automatic system.
	Hazardous content	VERY HIGH	WSN and RFID could be effectively applied to monitor real time condition of the workplace before and during the task.
Constraint 2	Source of Ignition	VERY HIGH	IOT could support a quick alarm detection by using WSNs or RFID sensors.
	Ingress of Substances	VERY HIGH	WSN and RFID could be effectively applied to monitor real time condition of the workplace before and during the task.
	Residues of the work activity	VERY HIGH	IOT could support a quick alarm detection by using WSNs or RFID sensors.
Constraint 3	Identify and evaluate causes and consequences of possible incidents	LOW	IOT could support updated knowledge about the task and the workplace.
	Define a standard approach to be used during the confined space	LOW	IOT could be used to evaluate critical factors outlined in such a procedure.
Emergency rescue		VERY HIGH	IOT could support updated knowledge about the task and the workplace but also about workers conditions.

Figure 3.18 The proposed impact analysis of IOT technologies.

Judgments have been obtained integrating results derived from the literature review and an expert analysis. Highest contributions could be outlined for assessing and monitoring the “Constrain 1 and 2” in the proposed framework and in the development of emergency operations. As reported in the previous section, some physical features influencing parameters in Constrain 1 and 2 could also affect the IOT technology that has to be applied.

As an example, if tasks to be developed are repetitive (e.g. 1 each week), a fixed transmission technology (e.g. based on Wifi) could be used.

On the other hand, if tasks are carried out in different place with a low frequency a mobile communication tool is more convenient.

### 3.2.2.3 Conclusions and considerations on the proposed framework for managing the risks of confined space work

This section has introduced a framework for defining the impact of IOT technologies for preventing and managing the risks of confined space work. Every year, confined space work causes fatal accidents and injuries. Despite the rising accident rates and the statistics on multiple-fatality incidents, confined space work procedures are not internationally standardized. Industrialized countries adopt several standards, regulations and codes of practice on confined space work, based on their local legislation. Recent pilot projects focus on the application of IOT technologies for confined space work. These technologies aim to interconnect objects and people by extracting selected data from the work environment and sharing such information with each other.

The framework in Section 3.16 is a useful tool to determinate the risks and the critical characteristics of confined spaces, i.e. it includes the analysis of the features of the confined space, the characteristics of the task and the characteristics of the emergency and rescue plan. Furthermore, the proposed framework helps to identify the impact of IOT technologies in preventing and managing risks in confined spaces.

Potential contributions of IOT technology-based system have been evaluated by adopting the proposed framework. Particularly, IOT technologies improve the information flow between the confined space and the actors involved in confined space activity, whether they are workers or rescuers. The highest contributions could be outlined for assessing and monitoring the characteristics of the confined space and the characteristics of the confined space work. Furthermore, IOT technologies can improve the emergency operations and ensure higher performances of the emergency intervention. Future developments include the application of the proposed framework to a real industrial case study regarding a pharmaceutical company.

### 3.2.3 Multi-criteria decision tool to control risks in confined space

This section proposes a multi-criteria model for assessing the most critical features requested to an IOT technology-based system for the management of the risks in confined spaces. Specifically, the model conceptualizes an AHP for analysing how critical factors affecting dangerous scenarios in confined spaces could affect the assessment of an IOT technology-based device for preventing and managing confined spaces risks. The aim is to evaluate the potential contribution of IOT technologies to prevent and control the risks of confined space work. After a brief overview of confined space risks in process industries, a test case in the chemical industry is introduced to validate the proposed approach.

#### 3.2.3.1 Analysis of confined space risks at process industries

Several industries face the risks of confined space work, i.e. confined areas characterize different processes in many industries, such as chemical industry (e.g. reaction vessels), food processing (e.g. above-ground storage silos) and utility sector (e.g. sewers and pipelines). Different factors contribute to increase the inherent complexity of confined space risks: multiple hazard sources, as electricity, lack of oxygen or inflammable atmosphere, are usually present, at the same time, during activities in confined spaces. In addition, the specific activity performed by confined space workers, (e.g. welding or cleaning), contribute to dynamically modify the risk level of the confined area. The current practice shows that many workplaces may become confined spaces when work is carried out, or during their construction or modification. The analysis of such “non-permanent” confined spaces shows that several of these locations are below ground level. Workers enter into these underground areas by means of narrow stairs or ladders, to perform maintenance, inspection, testing, sampling and repairing activities. Workers inside and outside a “non-permanent” confined space should be informed about both the changing conditions and the emerging risks due to the changing conditions of the work environment. The past and recent statistics in Section 3.1.1 have shown that the activity performed within the confined space contribute to increase the risk level of the confined area, leading to the accident generation. Furthermore, the analysed NIOSH data highlight high risk of confined space accident in the food and agricultural industry. Typical examples of high-risk confined spaces in agriculture include but are not limited to silos, grain bins and manure pits. Similar results are outlined by analysing accidents occurred from 2001 to 2015 in Italy (see Section 3.1.1). Italian data show critical results in the food processing industry, with several accidents due to confined space work in storage tanks, grape presses, fermentation tanks, utility vaults and vessels.

The following Section 3.2.3.2 introduces the multi-criteria model for the assessment of the most critical features requested to an IOT technology-based system for the management of the risks in confined spaces.

### 3.2.3.2 The proposed multi-criteria model

The problem in analysis is to evaluate how factors influencing risk levels could also affect the design of an IOT technology-based system to be adopted in a confined space. A multi-criteria approach has been used, based on the well-known AHP (Analytical Hierarchical Process) method (Saaty, 1980). The AHP method has been widely adopted to support several decision making problems regarding risk analysis in process industries (Sipahi and Timor , 2010; Gnoni et al., 2012, Zheng et al., 2013). The AHP method divides the problem in three main elements: the *goal*, which represent the decision problem in analysis, *alternatives*, which are the decision variable to be evaluated according to the goal, and, finally, different *levels of criteria*, which are organized in a hierarchical structure. Alternatives will be ranked quantitatively based on pairwise comparison carried out between criteria in the hierarchical structure, for each level.

In the proposed model, the *goal* is to identify most critical features, which should characterize the IOT technology-based system adopted to prevent and control risk in a confined space. Results provided by the model will allow safety managers to evaluate the most effective IOT technology-based systems, based on the specific risk level and not only on the technological features. Three technological requirements have been introduced as alternatives that characterize an IOT technology-based system:

- Reliability (A1): it focuses more on the service operations rather than the technical functionalities (Li et al, 2012). This requirement mainly refers to the capability of collecting data and providing effective feedbacks to workers for the confined space risk management. The aim is to evaluate the capability of the IOT technology-based system as a whole, i.e. this requirement does not refer to instrument precision values. Measurement performances characterizing each instrument or collection equipment are not considered under this requirement;
- Responsiveness (A2): this requirement refers to how the whole IOT technology-based system is able to collect information and provide feedbacks to the users in the workplace. One example is the capability of the IOT technology-based system to evaluate dynamic environment conditions and to provide pre-alarms to workers and/or rescue teams;
- Agility (A3): this requirement refers to how the IOT technology-based system interacts with the users and its level of usability, (e.g. manageability, automatic communication, etc.).

Three following first level criteria are based on the framework proposed in Section 3.2.2 for the analysis of the risks in confined spaces:

- Task factor (C1): it refers to the contribution of the work activity to the risk level increase, due to the intrinsic hazardousness of the task performed in the confined



space. Two second level criteria have been also added: equipment (C1.1) and activity factors (C1.2).

- Area factors (C2): this criterion refers to the contribution of the work environment to the risk level increase, due to specific features of the workplace where the task is carried out. Two second criteria have been also added such as Geometric (C2.1) and Ambient Air Factors (C2.2). Next, C2.1 criterion has been subdivided in two other criteria, such as Access Limitation (C2.1.1) and Space Congestion (C2.1.2); C2.2 criterion has been divided in two subsequent criteria, such as Hazardous content (C2.2.1) and Restricted air flow (C2.2.2)
- Hazard characteristics (C3): this criterion has been sub-divided based on the main risk categories that could affect the confined space activity: Mechanical (C3.1), Electrical (C3.2), Chemical (C3.3) and Other Hazards (C3.4).

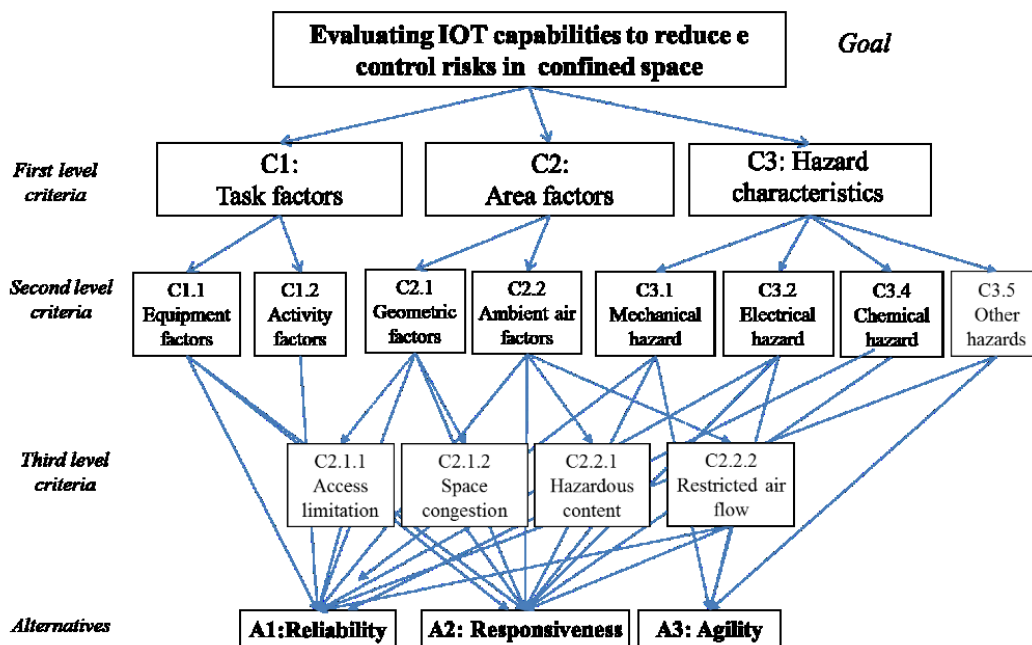

Figure 3.19 The proposed hierarchical structure

The hierarchical structure in Figure 3.18 shows the connections between the introduced goal, criteria and alternatives. The following test case shows the application of the proposed procedure to evaluate how factors influencing risk levels affect the design of an IOT technology-based system for confined spaces in the process industry.

### 3.2.3.3 Test case description

The following test case for validating the proposed multi-criteria approach in Figure 3.18 regards the hazardous tank cleaning for removing sludge or solids of an organic solvent in a chemical facility. Tanks are located underground. The activity is characterized by high

frequency; in addition, the total number of tanks to be periodically cleaned is relative high, i.e. it is equal to 11. Cleaning activities usually involve 3 workers. Thus, assessing and managing confined space risks requires a high effort for the company due to both its inherent complexity and its high frequency. The company is now evaluating the adoption of IOT technologies for preventing and controlling confined space risks during the repetitive cleaning activities. The multi-criteria model defined in the previous section has been adopted to provide feedbacks to the company.

Each criterion defined in the hierarchy proposed in the previous section has been detailed as follows.

*Hazard Characteristic:* all the three second level criteria introduced in the hierarchy could be evaluated by referring to the activity developed in the underground task. By evaluating the mechanical hazard criterion, three hazardous conditions have been outlined:

- falling into the vessel during the inspection of the hatch opening, leaning to the trapdoor margins could face an orthostatic problem, causing dizziness and / or light-headedness may result in a fall in the tank, related damage provided for the possibility of musculoskeletal trauma;
- falling during the entrance into the underground tank, after the step of opening the hatch and during the descent phase inside the tank could slip if the descent and safety devices do not have the appropriate characteristics, related damage provided for the possibility of musculoskeletal trauma;
- possibility of slipping into the vessel when the worker is in the tank to complete the cleaning operation, with even the presence of liquid and / or oily substances that may cause slippage, if the protective equipment is not used or if it does not have the appropriate features, related damage provided for the possibility of musculoskeletal trauma.

By evaluating the chemical hazard criterion, one critical condition is outlined. It refers to potential occurrence of dangerous atmospheres inside the tank due to the presence of VOCs and O<sub>2</sub>. The risk origins during the task execution due both to the stagnation of chemicals in the internal area and an initial mixing process occurred during the suction phase if there are some deficiencies and/or malfunctions in equipment.

By evaluating the electrical hazard criterion, one condition is outlined which refers to the occurrence of induced eddy currents, due to faults in the electrical protection system during the preliminary energy sources isolation process carried out before the task.

By evaluating the other hazard criterion, one outlined condition is the potential occurrence of an explosion due to the presence of saturated compounds which exceed the LEL (Level Explosion Limit) if not compliant equipment have been used during internal inspection and cleaning activities.

*Task hazardousness factors:* the activity to be carried out mainly consists in the cleaning process, aiming to remove all materials inside the tank. Three main steps could be outlined: a preliminary activity developed through the opened manhole entry, and, next, workers access the internal tank area to manually scarp residual materials. Finally, a sanitization activity is carried out. Specific equipment, as they have to be ATEX approved, used during these activities are sludge suction units, high pressure pumps, vacuum vents to maintain safe atmospheres in the tank.

*Area hazardousness factors:* the area in analysis is characterized by two main hazardous features, which are the restricted entrance for the tank inspection and underground location, and the potential gas accumulation in the internal area of the tank, which could lead to an explosive atmosphere. Furthermore, lack of oxygen could also occur due to the potential presence of VOCs (Volatile Organic Compounds) and O<sub>2</sub>.

In the next section, the quantitative application of the AHP method based on data regarding the test case is described in detail.

#### 3.2.3.4 Results analysis

The AHP procedure has been carried out following the structure in Figure 3.18. The goal is to outline the critical characteristics of a potential IOT technology-based system to be applied for the risk reduction of cleaning activity in the underground tanks described in the previous section. Thus, based on the multi-criteria model proposed, the criteria assessment phase has been carried out: each criterion, at each level, has been compared pairwise with respect to the criteria in the immediate upper level. A quantitative 1-to-9 scale has been adopted to develop expert criteria comparisons. Experts in risk analysis and control have developed the pairwise judgment process: the geometric mean value, which estimation is based on each expert judgment carried out in each pairwise comparison, has been adopted for evaluating the overall ranking of alternatives. Before analysing the final ranking, a validation analysis is carried out at each level of the AHP structure aiming to point out the possible inconstancy of such a single judgment. Saaty (1980) proposes to estimate a Consistency Index (*CI*), which characterizes the comparison (Saaty, 2000) matrix developed at the previous step; it is defined by Equation (30):

$$CI = \frac{\lambda_{max} - n}{n - 1} \quad (30)$$

where the  $\lambda_{max}$  is the maximum eigenvalue characterizing the matrix and  $n$  is the matrix dimension. Analogously, the Consistency Ratio (*CR*) parameter could be estimated as in (31):

$$CR = \frac{CI}{RI} \quad (31)$$

where the *RI* parameter is defined by Saaty (1977) as the Random Index, which represents the average *CI* value estimated for 500 randomly filled matrices. Thus, if the estimated *CR* value is less than 10%, the current matrix could be characterized by an acceptable level of

consistency (Saaty, 2000); otherwise, the decision makers should review and revise the pairwise comparisons. The estimated value for the test case is less than 10 % (i.e. about 8 %), thus all pairwise comparisons are proved to be consistent by the *CR* analysis. All scores estimated for each criterion for the proposed test case are reported in Table 3.5 together with the overall actual ranking of alternatives. Responsiveness is the most important technological requirement estimated for the test case with a final score of 37.6%; the estimated difference second and third alternative ranges from about 14% to 20%. Furthermore, scores estimated for each criterion at each level have been also evaluated: the most critical one for first level has been C2: this is in line with the real condition, where the task complexity is very low compared to the higher criticality characterizing the area where the task has to be developed.

Table 3.5 Estimated score values for each criterion and the three final alternatives

		Score [%]			Score [%]
First Level Criteria	C1: Task factors	0.143	FINAL RANKING	A1 Reliability	0.323
	C2: Area factors	0.571			
	C3: Hazard characteristics	0.286			
Second Level Criteria	C1.1 Activity factors	0.024		A2 Responsiveness	0.376
	C1.2 Equipment factors	0.119			
	C2.1 Ambient air factors	0.476			
	C2.2 Geometric factors	0.095			
	C3.1 Mechanical hazard	0.092			
	C3.2 Electrical hazard	0.035			
	C3.3 Chemical hazard	0.118			
C3.4 other hazards	0.040				
Third level criteria	Access Limitation	0.133	A3 Agility	0.299	
	Space congestion	0.033			
	Hazardous content	0.166			
	Restricted air flow	0.666			

### 3.2.3.5 Conclusions and considerations on the proposed multi-criteria model for assessing IOT technology

This section has proposed an application of a multi-criteria method for assessing quantitatively the most critical features required to IOT technology-based system to be adopted for preventing risks in confined spaces. Confined space risks are very complex to evaluate and manage as the risk level is affected by different factors depending on the hazardous level of the performed activities, as well as the geometric burdens characterizing the confined space. Thus, the decision problem in analysis is to evaluate how different features requested to the IOT technology could be more relevant based on the actual level of confined space risk. A test case regarding a repetitive cleaning activity developed in a chemical facility has been discussed aiming to validate the potentialities of the model through a numerical example. The model has revealed effective in outlining the features that will be

requested to an IOT technology-based system for preventing the risks of confined space work. Such IOT technology-based system will be developed following the directions from the results of the proposed the model.

Finally, IOT technology-based systems are useful technologies for the reduction of the risks due to confined space work. However, the complete elimination of the risks is possible when workers perform job from outside the confined area. Furthermore, the review of the accidents in confined spaces in previous Section 3.1.1 has shown that the improper identification of the confined space, and of the related risks, is the main cause of fatalities due to confined space work. The following Section 3.3 addresses the problem of the risk elimination in confined spaces, proposing the structure of a tool for the identification of such high-risk occupational environments.

## 3.3 ENGINEERING CONTROLS FOR CONFINED SPACE WORK

### 3.3.1 Tool for the identification of confined spaces in industry

The review on confined spaces in Section 3.1. showed that, despite the worldwide regulations and the standards on safety in confined spaces, fatalities and accidents still occur. Rescue attempts in confined spaces are also hazardous situations, since emergency response is a low-frequency, high-risk operation. Many would-be rescuers perish while trying to rescue a victim after a confined space accident. Would-be rescuers deaths include trained fire-fighters and competent personnel who had years of experience, despite the requirements for training, planning and expertise with confined space rescue procedures. Data and statistics reveal that the 60% of confined space fatalities in U.S. occur among would-be rescuers (NIOSH 1986). The chain of would-be rescuer deaths is an on-going phenomenon globally challenging. The Canadian Centre for Occupational Health and Safety and the European Agency for Safety and Health at Work (EU-OSHA) state the same 60-percent statistic (Muncy 2013). These data, as well as statistics on confined space accidents in previous Section 3.1, reveal a hidden phenomenon, i.e. both employers and workers fail to identify confined space work hazards (Burllet-Vienney, Chinniah & Bahloul 2014, Burllet-Vienney et al. 2015).

This section introduces the structure of a tool for the identification of confined spaces in industry. The aim was to realize an effective tool to prevent workers entry into high-risk confined spaces. The tool addresses workers during the complex identification of high-risk confined spaces. When the presence of the confined space is confirmed, the tool defines a set of preventive measures to adopt before allowing employee entry. Finally, the tool supports the mandatory risk assessment for confined spaces computing the risk index for the analysed confined space and task.

#### 3.3.1.1 Identifying confined spaces: a challenging task

The U.S. OSHA outlines the confined space features to help employers and employees in recognizing such hazardous workplaces. Following the OSHA's definition in the PRCS, three features characterize a confined space: is large enough and configured that an employee can enter and perform work, has limited openings of entry or exit, and is not designed for continuous occupancy (OSHA 1993). Examples of confined spaces include silos, vessels, boilers, storage tanks, sewers and pipelines. The PRCS outlines the boundary line between non-permit and permit-required confined spaces, i.e. a permit-required confined space is distinguished by the hazards present and the ability of the employer to eliminate them (Ye 2011). Particularly, a permit-required confined space contains or has potential to contain a hazardous atmosphere, contains a material that could potentially engulf a worker, has an

internal configuration that could trap or asphyxiate a worker, or presents any other serious, recognized hazard. This definition has been repeated for years, mentioning the OSHA regulations and analysing every detail. Design features of confined spaces increase risk to entrants. Such features include the physical configuration of entry and exit portals, structural weaknesses in walls and the absence of anchor points necessary for effecting emergency rescue (Wilson, Madison & Healy 2012).

Despite work in such hazardous workplaces is regulated by specific procedures, e.g. OSHA 29 CFR 1910.146, accidents and injuries still occur. The PRCS is considered one of the most difficult OSHA's standards to comprehend, likely is the hardest with which to comply (Taylor 2011). In his study, Taylor shows common misconceptions and errors about confined space issues, revealing that most employers are not in compliance with the confined space regulation, due to complexity and ambiguousness of the PRCS.

The tool for the confined space identification includes a simplified application of the PRCS definition. The characteristics of the confined space are gathered in four different categories:

- Geometric features
- Access
- Internal configuration
- Atmosphere and environment

The following Figure 3.20 shows the details of the characteristics of confined spaces for each category.

<b>CHARACTERISTICS OF CONFINED SPACES</b>	
<b>GEOMETRIC FEATURES</b>	<p>Necessary condition for the geometrically confined space: <i>Large enough and so configured that an employee can bodily enter and perform assigned work.</i> Geometrically limited if at least one of its dimensions &lt;1800 mm</p> <hr/> <p><b>Aggravating conditions:</b></p> <ul style="list-style-type: none"> <li>▪ Depressed or includes hollowed areas</li> <li>▪ Extended or divided in more areas, far from the access</li> </ul>
<b>ACCESS</b>	<p>Necessary condition for the confined access: <i>Has limited or restricted means for entry or exit.</i> Diameter or the shortest dimension of the access &lt; 600mm</p> <hr/> <p><b>Aggravating conditions:</b></p> <ul style="list-style-type: none"> <li>▪ The access is vertical only</li> <li>▪ Singular or limited number of access/escapes</li> <li>▪ Access is not protected or signaled</li> </ul>
<b>INTERNAL CONFIGURATION</b>	<p>Necessary condition for the confined internal configuration: Not designed for continuous employee occupancy</p> <hr/> <p><b>Aggravating conditions:</b></p> <ul style="list-style-type: none"> <li>▪ Contains a material that has the potential for engulfing an entrant</li> <li>▪ Internal configuration such that an entrant could be trapped or asphyxiated by inwardly converging walls or by a floor which slopes</li> <li>▪ Contains any other recognized serious safety or health hazard</li> <li>▪ Presence of materials with bad stability</li> <li>▪ Risk of slips, trips and falls</li> <li>▪ Presence of particular areas (e.g., bottlenecks, blind spots, convergences)</li> <li>▪ Presence of closed areas</li> <li>▪ Presence of plants</li> <li>▪ Presence of pipes connected to internal or external plants</li> <li>▪ Presence of residuals from previous operations</li> <li>▪ Presence of residuals that obstruct the access or the walkability</li> <li>▪ Absence of isolation from the ground</li> <li>▪ Proximity to areas with the aforementioned characteristics</li> </ul>
<b>ATMOSPHERE AND ENVIRONMENT</b>	<p>Necessary condition for the confined atmosphere and environment: <i>Contains or has potential to contain a hazardous atmosphere.</i> Absence of a natural or artificial efficient ventilation system that ensures proper ventilation in every accessible point</p> <hr/> <p><b>Aggravating conditions:</b></p> <ul style="list-style-type: none"> <li>▪ Contains or has a potential to contain a hazardous sources of energy</li> <li>▪ High pressure or high/low temperature</li> <li>▪ Poor illumination</li> <li>▪ Noise</li> <li>▪ Interferences in communication</li> <li>▪ Contains hazardous concentrations of substances (low/high oxygen level, explosive substances, toxic substances)</li> <li>▪ Expected hot works</li> <li>▪ Expected cold works</li> <li>▪ Expected works with exhalations</li> <li>▪ Expected stock of heavy or bulky materials</li> <li>▪ Expected tests</li> </ul>

Figure 3.20 Characteristics of confined spaces

Limited dimensions characterize confined spaces. Following the definition of the OSHA's standard 29 CFR 1910.146, a confined space is large enough and so configured that an employee can bodily enter and perform assigned work. The concept of limitation of a



dimension is referred to the dimension of the human body, fully equipped to face the worst possible scenario. The minimum working area of a worker may be computed as the circumference drawn by his arm. Given the length of the arm of the 99 percentile man as equal to 800 mm (Tilley & Henry Dreyfuss Associates, 2002) and an increase due to the PPE (e.g., protective gloves) of 5 mm, the minimum working area of a worker is equal to a circumference with a ray of 805 mm. As a consequence, the space can be defined as “geometrically confined” if the circumference with a diameter of 1,800 mm (ray 900 mm) and centre at the intersection between the transverse plane and the longitudinal axis is not completely clear and free from obstructions. Aggravating conditions of the geometric features of a confined space include the presence of hollowed areas and extensions far from the entry.

The international standards on anthropometric measures provide further useful dimensions of the human body (e.g., UNI EN 547 Parts 1, 2 and 3, UNI EN ISO 7250:2000, UNI EN ISO 15537:2005 and UNI EN ISO 15535:2007). Such standards allow determining the dimensions of the human body ellipse, which are 600 mm for the major axis (shoulder breadth) and 450 mm for the minor axis (body width). As a consequence, the access of a space is confined if the diameter or the shortest dimension of the entry is smaller than 600 mm. The presence of a singular vertical access or the lack of protection and signal are aggravating conditions of the confined access.

The internal configuration refers to the internal characteristics of the space. The necessary condition of the confined internal configuration is that the space is not designed for continuous occupancy. The presence of material that has the potential for engulfing the entrant or residuals from previous operations increase the exposure of the worker to the risks of confined space work, aggravating the conditions of the confined space.

Finally, a space is atmospherically confined if it contains or has potential to contain a hazardous atmosphere. Specifically, the absence of a natural or artificial efficient ventilation system that ensures proper ventilation in every accessible point is the necessary condition to define the confined atmosphere of the space. Aggravating conditions of the atmospherically confined space include the characteristics of the expected operations, (e.g., hot and cold works, stock of heavy and bulky materials, and tests), high concentrations of explosive and toxic substances, and the presence of noise.

Each confinement category identifies a dimension of the confined space. Specifically, a space can be limited in four different dimensions, i.e. geometric features, access, internal configuration, and atmosphere and environment. Based on the structure of confined space characteristics in previous Figure 3.20, the following Section 3.3.1.2 shows the algorithm for the identification of confined spaces.

#### 3.3.1.2 Algorithm for the identification of a confined space

The categories in Figure 3.20 show a structured representation of the characteristics of confined spaces. The presence of a confined space is confirmed when a necessary condition

is verified. Therefore, the space can be confined either in its geometric features, access, internal configuration, and atmosphere and environment. These categories define the structure of the algorithm for the identification of confined spaces in the following Figure 3.21.

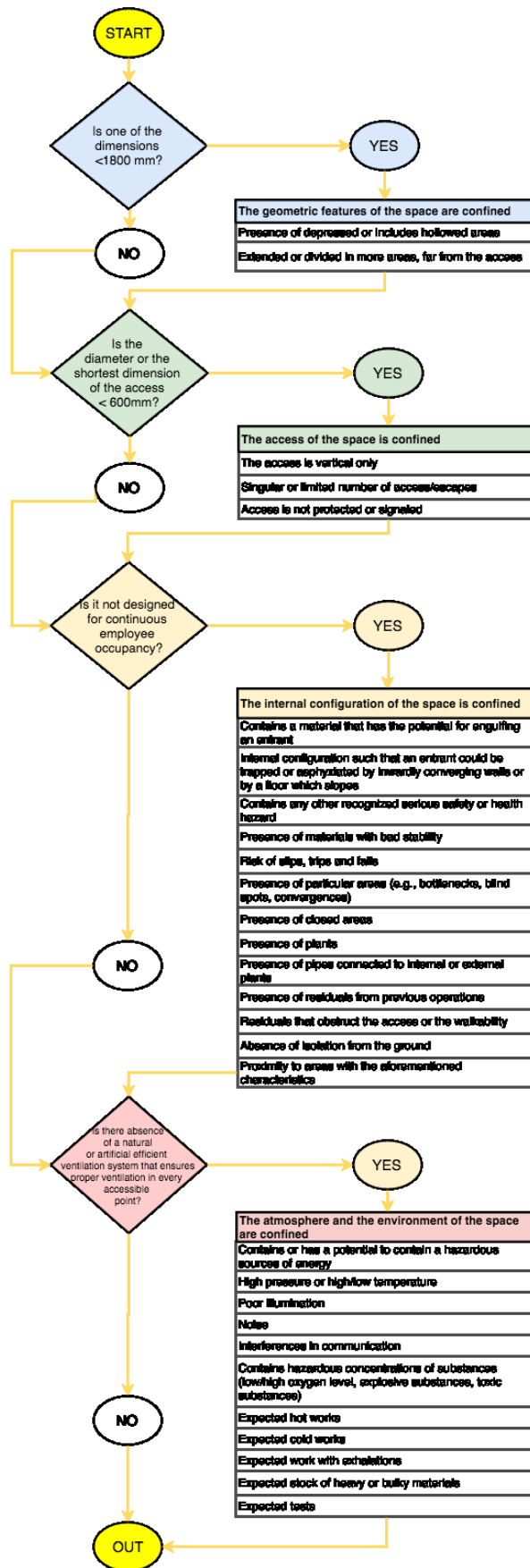

Figure 3.21 Algorithm of the confined space identification tool

The algorithm in Figure 3.21 guides workers and practitioners through the process for the identification of confined spaces. Specifically, the answer “YES” to one of the four necessary conditions defines the presence of a confined space. The types of confinement refer to the specific categories for which the user answers “YES”. In case of affirmative answer, the procedure suggests the investigation of the aggravating conditions. Based on the algorithm in Figure 3.21, the following Figure 3.22 shows a checklist including both necessary and aggravating conditions, for each category.

<b>IDENTIFICATION OF A CONFINED SPACE</b>		
<i>Review each condition for the suspected confined space of interest, place a tick in the column on the right as appropriate.</i>		
<i>CATEGORY</i>	<i>CONDITION</i>	<i>CONCERN</i>
<b>GEOMETRIC FEATURES</b>	A1. Geometrically limited if at least one of its dimensions <1800 mm	
	A2. Depressed or includes hollowed areas	
	A3. Extended or divided in more areas, far from the access	
<b>ACCESS</b>	B1. Diameter or the shortest dimension of the access < 600mm	
	B2. The access is vertical only	
	B3. Singular or limited number of access/escapes	
	B4. Access is not protected or signaled	
<b>INTERNAL CONFIGURATION</b>	C1. Not designed for continuous employee occupancy	
	C2. Contains a material that has the potential for engulfing an entrant	
	C3. Internal configuration such that an entrant could be trapped or asphyxiated by inwardly converging walls or by a floor which slopes	
	C4. Contains any other recognized serious safety or health hazard	
	C5. Presence of materials with bad stability	
	C6. Risk of slips, trips and falls	
	C7. Presence of particular areas (e.g., bottlenecks, blind spots, convergences)	
	C8. Presence of closed areas	
	C9. Presence of plants	
	C10. Presence of pipes connected to internal or external plants	
	C11. Presence of residuals from previous operations	
	C12. Presence of residuals that obstruct the access or the walkability	
	C13. Absence of isolation from the ground	
	C14. Proximity to areas with the aforementioned characteristics	
<b>ATMOSPHERE AND ENVIRONMENT</b>	D1. Absence of a natural or artificial efficient ventilation system that ensures proper ventilation in every accessible point	
	D2. Contains or has a potential to contain a hazardous sources of energy	
	D3. High pressure or high/low temperature	
	D4. Poor illumination	
	D5. Noise	
	D6. Interferences in communication	
	D7. Contains hazardous concentrations of substances (low/high oxygen level, explosive substances, toxic substances)	
	D8. Expected hot works	
	D9. Expected cold works	
	D10. Expected work with exhalations	
	D11. Expected stock of heavy or bulky materials	
	D12. Expected tests	

Figure 3.22 Checklist for the identification of a confined space.

The checklist is part of the risk assessment required by the current law. Workers and practitioners complete the checklist prior to perform the operations in the suspected confined space. A tick is assigned to each condition concerning the situation in the suspected confined space. The ticks in the four questions A1, B1, C1 and D1 on necessary conditions define the presence of the confined space. As an example, a tick in questions A1, B1 and D1 define a space with limited geometric features, limited access and atmospherically confined.

The aggravating conditions contribute to the quantification of the risk index for the suspected confined space. When a necessary condition is not identified, the user skips the aggravating conditions for the corresponding category and moves to the next (e.g., if A1 does not concern the suspected confined space, skip A2 and A3, and go to condition B1). The definition of the risk index and the parameters for its calculation are in the following Section 3.3.1.3.

### 3.3.1.3 Confined Space Risk Index (CSRI)

The answers to the questions of the checklist in Figure 3.22 contribute to the definition of the Confined Space Risk Index (CSRI). Specifically, a score of one is attributed to each answer with the tick. Questions without the tick have no score. The space is confined if at least one of the necessary conditions A1, B1, C1 or D1 is concerned. The aggravating conditions in each category contribute to increase the CSRI. The following Equation (32) defines the CSRI.

$$CSRI = A1 \cdot \left[1 + \left(\frac{\sum_{i=A2}^{A3} Ai}{2}\right)\right] + B1 \cdot \left[1 + \left(\frac{\sum_{i=B2}^{B4} Bi}{3}\right)\right] + C1 \cdot \left[1 + \left(\frac{\sum_{i=C2}^{C4} Ci}{13}\right)\right] + D1 \cdot \left[1 + \left(\frac{\sum_{i=D2}^{D4} Di}{11}\right)\right] \quad (32)$$

CRSI is a number between 0 and 8. The value of the CRSI is 0 if no necessary condition for confinement concerns the space investigated. The maximum value for the CRSI is equal to 8 and it represents a confined space where all the necessary and aggravating conditions are verified.

The value of the resulting index is then compared with the ranges defining the risk level, as in the following Table 3.6.

Table 3.6 Ranges that define risk levels

CSRI Value	Risk Level	Consequences
0	No risk	No confined space, no consequences
$1 \leq CSRI < 3$	Low risk	Acceptable: no significant consequences
$3 \leq CSRI < 5$	Medium risk	Improve structural risk factors or adopt risk control measures
$5 \leq CSRI \leq 8$	Significant risk	Redesign tasks and workplaces according to priorities. Avoid entry if possible.

Working in confined space poses or is likely to pose a risk to the safety and health of workers. In case of low risk, risk control measures as engineering controls, administrative controls and

PPE should be taken. When the risk is high, workers should not enter the confined space. Tasks should be redesigned to avoid man entry and including the adoption of non-man entry technologies for work in confined spaces. A possible alternative is the redesign of the workplace to eliminate the necessary conditions concerning the identified confined space.

The following Section 3.3.1.4 shows two practical applications of the checklist and the CSRI for two confined spaces in industry.

#### 3.3.1.4 Quick applications of the checklist and CSRI calculation

##### 3.3.1.4.1 Case study 1: Grain silo

The first case study concerns the application of the proposed checklist for the risk assessment of silos for grain storage in an Italian mill. Silos have a rectangular section of 15 x 21 m. The height is 40 m. The internal surfaces have no openings, except for two manholes, which are on the top and on the lower part of the silo. The dimensions of the top manhole are 500 x 600 mm, while the lower manhole is 500 x 500 mm. Workers occasionally enter the silos for maintenance operations (e.g., unplug materials on the walls and inspect the grain). Such activities do not require specific equipment. Workers usually enter the space from the top manhole, with a shovel and a flashlight.

Following the checklist in Figure 3.22, the necessary conditions for confinement concerning the space are B1, C1 and D1. As a consequence, the investigated silo is a confined space as its entries, internal configuration and atmosphere are confined. Further conditions concerning the space are B3, B4, C2, C3, C5, C6, C7, C14, D4 and D11. Following the Equation (32) for the calculation of the risk index, the resulting CSRI is equal to 4.3. A medium risk level concerns the investigated confined space (Table 3.6) and the risk factors should be improved to reduce the risk level.

##### 3.3.1.4.2 Case study 2: Metal tank in filtration plants

The manufacturing process of swimming pool filters requires workers to enter a cylindrical tank to perform welding of the metal components of the tank (e.g., top, lateral metal sheet, bottom and other small components). The tank diameter is 3 m. During welding operations, a positioning device sustains the tank with the diameter perpendicular to the floor. The width of the internal space where worker welds components is about 1.3 m, while the height is 3 m (tank diameter). The worker enters the tank through a manhole of DN 500.

All the four necessary conditions of the checklist concern the space, i.e. the tank is a confined space. Further aggravating conditions are B3, B4, C14, D2, D3, D4, D8 and D10. The resulting CSRI is 5.2, which involves significant risk for the investigated confined space. Workers should not enter the space and the redesign of the task is suggested. For example, an autonomous welding robot could enter the tank, while manual worker supervises from the outside.

### 3.3.1.5 Findings and future developments

This Section has introduced an algorithm for confined spaces in industry. The aim was to define an algorithm for the identification of high risk confined spaces and prevent workers access. The analysis of fatalities due to confined space work showed that the lack of awareness about the presence and the risk of confined spaces is the main cause of accident. The proposed algorithm defines a structured framework for the recognition of confinement characteristics of workplaces. Four categories of confinement have been defined to identify confined spaces: geometric features, access, internal configuration, and atmosphere and environment. A necessary condition and a set of aggravating conditions characterize each confinement category. The workplace concerning at least one of the proposed necessary conditions is a confined space. Based on the structure of the proposed algorithm, a checklist was developed to address workers and practitioners through the identification of confined spaces in industry. Finally, the Confined Space Risk Index (CSRI) analyses the risk of the confined space, defining the risk level.

This study will be the base for the development of an interactive tool for the identification of confined spaces in industry. The tool will have a user-friendly interface and it will be accessible online from personal computers and other electronic devices (e.g., smart phones and tablets). Lastly, the CSRI will be improved including accident frequencies and the related risk factors.



## 3.4 REFERENCES

ANSI/ASSE 2009, *Safety requirements for confined spaces with Comparison Document for versions 1995, 2003 and 2009*, American National Standards Institute (ANSI), American Society of Safety Engineers (ASSE), Des Plaines, IL.

ANSI/ISA 2007, *Performance Requirements for Instruments Used To Detect Oxygen-Deficient/Oxygen-Enriched Atmospheres*, American National Standards Institute (ANSI), Instrumentation Systems and Automation Society (ISA).

ASTM 2012, *Standard Practice for Confined Area Entry*, American Society for Testing and Materials (ASTM) International, West Conshohocken, PA.

Atzori, L., Iera, A., & Morabito, G., 2010. The internet of things: A survey. *Computer networks*, 54(15), 2787-2805.

Bellamy, L.J. 2015, "Exploring the relationship between major hazard, fatal and non-fatal accidents through outcomes and causes", *Safety Science*, vol. 71, Part B, pp. 93-103.

Bibuli, M., Bruzzone, G., Bruzzone, G., Caccia, M., Giacomelli, M., Petitti, A. & Spirandelli, E. 2012, "MARC: Magnetic Autonomous Robotic Crawler Development and Exploitation in the MINOAS Project", *International Conference on Computers and IT Applications in the Maritime Industries (COMPIT) 2012*, pp. 62.

Bizzotto, M. 2014, *Ancora incidenti mortali in luoghi confinati: 2 morti a Molfetta*.

Bogue, R. 2010, "The role of robotics in non-destructive testing", *Industrial Robot*, vol. 37, no. 5, pp. 421-426.

Borgia, E., 2014. The Internet of Things vision: Key features, applications and open issues. *Computer Communications*, 54, 1-31.

Botti, L., Duraccio, V., Gnoni, M.G., Mora, C., 2015. A framework for preventing and managing risks in confined spaces through IOT technologies, *Safety and Reliability of Complex Engineered Systems - Proceedings of the 25th European Safety and Reliability Conference, ESREL 2015*, pp. 3209-3217.

Botti, L., Mora, C. & Regattieri, A. 2015, "Improving ergonomics in the meat industry: A case study of an Italian ham processing company", *IFAC Proceedings Volumes (IFAC-PapersOnline)*, pp. 598.

- Bouchagiar, I. 2014, "Choosing the optimum tank cleaning system", *Tank Storage Magazine*, vol. 10, no. 2, pp. 109-111.
- Bradbeer, R., Ku, K.K., Yeung, L.F. & Lam, K.Y. 2005, "An underwater camera for security and recreational use", *Consumer Electronics, 2005. (ISCE 2005). Proceedings of the Ninth International Symposium on*, pp. 364.
- Burlet-Vienney, D., Chinniah, Y. & Bahloul, A. 2014, "The need for a comprehensive approach to managing confined space entry: Summary of the literature and recommendations for next steps", *Journal of Occupational and Environmental Hygiene*, vol. 11, no. 8, pp. 485-498.
- Burlet-Vienney, D., Chinniah, Y., Bahloul, A. & Roberge, B. 2015, "Occupational safety during interventions in confined spaces", *Safety Science*, vol. 79, pp. 19-28.
- Dandan, K., Ananiev, A. & Kalaykov, I. 2013, "SIRO: The silos surface cleaning robot concept", *IEEE International Conference on Mechatronics and Automation (ICMA), 2013*, pp. 657.
- Eich, M., Bonnin Pascual, F., Garcia Fidalgo, E., Ortiz, A., Bruzzone, G., Koveos, Y. & Kirchner, F. 2014, "A robot application for marine vessel inspection", *Journal of Field Robotics*, vol. 31, no. 2, pp. 319-341.
- Eich, M. & Vogele, T. 2011, "Design and control of a lightweight magnetic climbing robot for vessel inspection", *19th Mediterranean Conference on Control & Automation (MED), 2011*, pp. 1200.
- Elia, V., & Gnoni, M. G., 2013. Pervasiveness of RFID technology: A survey based on case studies analysis. *International Journal of RF Technologies*, 5(1-2), 41-61.
- Elkmann, N., Althoff, H., Kutzner, S., Stuerze, T., Saenz, J. & Reimann, B. 2007, "Development of fully automatic inspection systems for large underground concrete pipes partially filled with wastewater", *Proceedings IEEE International Conference on Robotics and Automation* Institute of Electrical and Electronics Engineers Inc., pp. 130.
- Estrada, E., Silveira, L., Gonçalves, E., Filho, N.D., de Oliveira, V. & Botelho, S. 2010, "Autonomous navigation for underground energy line inspection robot", *1st International Conference on Applied Robotics for the Power Industry (CARPI), 2010*, pp. 1.
- Flynn, M.R. & Susi, P. 2010, "Manganese, iron, and total particulate exposures to welders.", *Journal of Occupational and Environmental Hygiene*, vol. 7, no. 2, pp. 115-126.

- Foreverpipe 2015, , *New technologies for underground pipelines rehabilitation*. Available: [http://www.foreverpipe.it/eng\\_index.htm](http://www.foreverpipe.it/eng_index.htm) [2015, Jul.].
- Gelenbe, E., & Wu, F. J., 2013. Future research on cyber-physical emergency management systems. *Future Internet*, 5(3), 336-354.
- Glass, S.W. & Klahn, F.C. 2011, "ReTRIEVR, a long-reach robot for tank or silo waste retrieval", *Waste Management Conference 2001 WM'01*.
- Gnoni, M. G., Lettera, G., Bragatto, P. A., 2012. A multi-criteria decision model for controlling knock-on risk inside chemical plants. *Chemical Engineering Communications*, 199(6), 798-811.
- Goldenberg, A., Gryniowski, M. & Campbell, T. 2010, "AARM: A robot arm for internal operations in nuclear reactors", *1st International Conference on Applied Robotics for the Power Industry (CARPI), 2010*, pp. 1.
- Gonzalez De Santos, P., Armada, M.A. & Jimenez, M.A. 2000, "Ship building with ROWER", *Robotics & Automation Magazine, IEEE*, vol. 7, no. 4, pp. 35-43.
- Granosik, G. 2014, "Hypermobile robots - The survey", *Journal of Intelligent & Robotic Systems*, vol. 75, no. 1, pp. 147-169.
- Guan, Y., Zhu, H., Wu, W., Zhou, X., Jiang, L., Cai, C., Zhang, L. & Zhang, H. 2013, "A modular biped wall-climbing robot with high mobility and manipulating function", *IEEE/ASME Transactions on Mechatronics*, vol. 18, no. 6, pp. 1787-1798.
- Hansen, S. 1999, *Confined space rescue operations standard operating procedures*, National Fire Academy, Executive Fire Officer Program, Emmitsburg, MD.
- Harris, M.K., Ewing, W.M., Longo, W., DePasquale, C., Mount, M.D., Hatfield, R. & Stapleton, R. 2005, "Manganese exposures during Shielded Metal Arc Welding (SMAW) in an enclosed space", *Journal of Occupational and Environmental Hygiene*, vol. 2, no. 8, pp. 375-382.
- HSE INDG258(rev1) 2013, *Confined spaces: A brief guide to working safely*, Health and Safety Executive.
- HSE (ed) 2014, *Confined Spaces Regulations 1997. Approved Code of Practice, Regulations and guidance*, Third edition edn, Health and Safety Executer (HSE).
- HSE (ed) 1999, *The management of health and safety at work regulations*, Health and Safety Executive (HSE).

- HSE (ed) 1997, *Confined Spaces Regulations*, Health and Safety Executer (HSE).
- Hunter, M., Liporace, F. & Hamlett, S. 2010, "Automatic mud tank cleaning system cuts costs, risks", *Offshore*, vol. 70, no. 9, pp. 66-68.
- Idaho National Engineering and Environmental Laboratory 2000, *Robotic Tank Inspection End Effector*, U.S. Department of Energy Office of Environmental Management Office of Science and Technology, Idaho Falls, Idaho.
- Jetstream 2013, , *Jetstream Magnetic Crawler M250*. Available: <http://www.jetstreameurope.co.uk/products/magnetic-crawler>.html. [2015, Jul.].
- Kershaw, K., Chapron, F., Coin, A., Delsaux, F., Feniet, T., Grenard, J.-. & Valbuena, R. 2007, "Remote inspection, measurement and handling for LHC", *IEEE Particle Accelerator Conference, 2007. PAC.*, pp. 332.
- Kim, K., & Kim, M. 2012, "RFID-based location-sensing system for safety management", *Personal and Ubiquitous Computing*, vol 16, no. 3, pp. 235-243.
- Kirchner, F. & Hertzberg, J. 1997, "A prototype study of an autonomous robot platform for sewerage system maintenance", *Autonomous Robots*, vol. 4, no. 4, pp. 319-331.
- Kirkham, R. 2000, "PIRAT-A System for Quantitative Sewer Pipe Assessment.", *The International Journal of Robotics Research*, vol. 19, no. 11, pp. 1033-1053.
- Kovacic, Z., Balac, B., Flegaric, S., Brkic, K. & Orsag, M. 2010, "Light-weight mobile robot for hydrodynamic treatment of concrete and metal surfaces", *1st International Conference on Applied Robotics for the Power Industry (CARPI), 2010*, pp. 1.
- Krasny, D.P. 2012, "The Autonomous Maintenance Robot (AMR) for Confined Space Maintenance Applications", *Naval Engineers Proceedings for Fleet Maintenance & Modernization Symposium*.
- Kuntze, H.B., Schmidt, D., Haffner, H. & Loh, M. 1995, "KARO - A flexible robot for smart sensor-based sewer inspection", *Interantional No-Dig Conference*, pp. 367.
- Li, L., Jin, Z., Li, G., Zheng, L., & Wei, Q., 2012a. Modeling and analyzing the reliability and cost of service composition in the IoT: a probabilistic approach. In *Web Services (ICWS), 2012 IEEE 19th International Conference on* (pp. 584-591). IEEE.
- Li, N., Sun, M., Bi, Z., Su, Z., & Wang, C., 2014b. A new methodology to support group decision-making for IoT-based emergency response systems. *Information Systems Frontiers*, 16(5), 953-977.

- Liu, S. J., & Zhu, G. Q., 2014. The application of GIS and IOT technology on building fire evacuation. *Procedia engineering*, 71, 577-582.
- Longo, D. & Muscato, G. 2004, "A modular approach for the design of the Alicia3 climbing robot for industrial inspection", *Industrial Robot*, vol. 31, no. 2, pp. 148-158.
- Luk, B.L., Collie, A.A., Cooke, D.S. & Chen, S. 2006, "Walking and climbing service robots for safety inspection of nuclear reactor pressure vessels", *Measurement and control*, vol. 39, no. 2, pp. 43.
- Manca, D., Nazir, S., & Colombo, S. (2012). Performance indicators for training assessment of control-room operators. *Chemical Engineering Transactions*, 26, 285- 290.
- Manca, D., Nazir, S., Colombo, S., & Kluge, A. (2014). Procedure for automated assessment of industrial operators. *Chemical Engineering Transactions*, 36, 391-396.
- Marsh, C.P., Siddique, A., Temple, B.A. & Hock, V.F. 2004, *Fury : robotic in-situ inspection/condition assessment system for underground storage tanks*, US Army Corps of Engineers, Engineer Research and Development Center, Construction Engineering Research Laboratory.
- Meeker, J.D., Susi, P. & Flynn, M.R. 2010, "Hexavalent chromium exposure and control in welding tasks", *Journal of Occupational and Environmental Hygiene*, vol. 7, no. 11, pp. 607-615.
- Miko 2013, , *Steel climber*. Available: <http://www.miko.no/steel-climber/> [2015, Jul.].
- Ministero del Lavoro e delle Politiche Sociali 2011, *DPR 177/2011 Regolamento recante norme per la qualificazione delle imprese e dei lavoratori autonomi operanti in ambienti sospetti di inquinamento o confinanti*.
- Ministero del Lavoro e delle Politiche Sociali 2008, *D.lgs 9 aprile 2008, n.81 TU Testo Unico sulla salute e sicurezza sul lavoro*.
- Muncy, C. 2013, "The Sixty Percent Statistic. How to break the chain of would-be rescuer deaths in confined spaces", *The Synergist*, vol. 24, no. 2, pp. 24-25,26.
- Nano, G., Derudi, M., 2012. Evaluation of Workers Accidents Through Risk Analysis, *Chemical Engineering Transactions* , 16, 495-500.
- Nano, G., Derudi, M., 2014. A Critical Analysis of Techniques for the Reconstruction of Workers Accidents, *Chemical Engineering Transactions*, 31, 415-420.

- Nassiraei, A.A.F., Kawamura, Y., Ahrary, A., Mikuriya, Y. & Ishii, K. 2007, "Concept and Design of A Fully Autonomous Sewer Pipe Inspection Mobile Robot KANTARO", *IEEE International Conference on Robotics and Automation, 2007*, pp. 136.
- Nelson, B., Slebodnick, P., Wegand, J., Lysogorski, D. & Lemieux, E.J. 2012, "Corrosion Sensors and ISIS: A Condition-Based Approach to the Inspection and Preservation of Tanks and Voids on US Navy Ships", *Naval Engineers Journal*, vol. 124, no. 1, pp. 115-129.
- NIOSH 1994, 94-103 *Worker deaths in confined spaces. A summary of NIOSH surveillance and investigative findings*, U.S. Department of Health and Human Services, Public Health Service, Centers for Diseases Control and Prevention, National Institute for Occupational Safety and Health (NIOSH), Cincinnati, OH.
- NIOSH 1987, 87-113 *A guide to safety in confined spaces*, U.S. Department of Health and Human Services, Public Health Service, Centers for Disease Control, National Institute for Occupational Safety and Health, DHHS (NIOSH), Cincinnati, OH.
- NIOSH 1986, 86-110 *NIOSH Alert: Request for Assistance in Preventing Occupational Fatalities in Confined Spaces*, U.S. Department of Health and Human Services, Public Health Service, Centers for Disease Control, National Institute for Occupational Safety and Health, DHHS (NIOSH), Cincinnati, Ohio.
- NIOSH 1979, 80-106 *Criteria for a Recommended Standard: Working in Confined Spaces*, U.S. Department of Health, Education, and Welfare, Public Health Service, Centers for Disease Control, National Institute for Occupational Safety and Health, DHEW (NIOSH), Morgantown, WV.
- Ortiz, F., Pastor, J.A., Alvarez, B., Iborra, A., Ortega, N., Rodriguez, D. & Concsa, C. 2007, "Robots for hull ship cleaning", *IEEE International Symposium on Industrial Electronics, 2007. ISIE 2007*, pp. 2077.
- OSHA a, 29 CFR 1915 Subpart B. *Occup. Safety and Health Standards for Shipyard Employment. Confined and Enclosed Spaces and Other Dangerous Atmospheres in Shipyard Employment*, U.S. Department of Labor, Occupational Safety and Health Administration (OSHA).
- OSHA b, 29 CFR 1910.272 *Occupational Safety and Health Standards. Special Industries. Grain handling facilities*, U.S. Department of Labor, Occupational Safety and Health Administration (OSHA).

- OSHA c, 1926.21 *Safety and Health Regulations for Construction. General Safety and Health Provisions. Safety training and education*, U.S. Department of Labor, Occupational Safety and Health Administration (OSHA).
- OSHA 1993, 1910.146 *Occupational Safety and Health Standards. General Environmental Controls. Permit-required confined spaces*, U.S. Department of Labor, Occupational Safety and Health Administration (OSHA).
- OSHA 2002, 3071 *Job Hazard Analysis*, U.S. Department of Labor Occupational Safety and Health Administration (OSHA).
- OSHA 2004, 3138-01R *Permit Required Confined Spaces*, U.S. Department of Labor Occupational Safety and Health Administration (OSHA).
- OSHA 2015, 29 CFR 1926 *Safety and Health Regulations for Construction. Confined Spaces in Construction. Authority for 1926 Subpart AA.*, U.S. Department of Labor, Occupational Safety and Health Administration (OSHA).
- Pagcatipunan, C. 2003a, "Cut Costs With Automated Tank Cleaning", *Industrial Maintenance & Plant Operation*, vol. 64, no. 12, pp. 22-23.
- Pagcatipunan, C. 2003b, "Options for Automated Tank Cleaning", *Chemical Engineering*, vol. 110, no. 8, pp. 27-32.
- Pathak, M.K., Singh, P. & Bansal, A. 2013, "Manipulator arm for handling of objects in confined spaces", *Proceedings of Conference on Advances In Robotics* ACM, New York, NY, USA, pp. 1.
- Petroltecnica 2015a, , *Bruco - Automatic device for underground tanks cleaning No Man Entry*. Available: <http://www.petroltecnica.it/smart-bruco> [2015, Jul.].
- Petroltecnica 2015b, , *Camaleonte – Robot motorizzato per pulizia, rilievo spessori e sabbiatura di serbatoi interrati*. Available: <http://www.petroltecnica.it/camaleonte-robot-motorizzato-per-pulizia-rilievo-spessori-e-sabbiatura-di-serbatoi-interrati-2> [2015, Jul.].
- Petroltecnica 2015c, , *Ragno*. Available: <http://www.petroltecnica.it/ragno> [2015, Jul.].
- Qiuping, W., Shunbing, Z., & Chunquan, D., 2011. Study on key technologies of Internet of Things perceiving mine. *Procedia Engineering*, 26, 2326-2333.
- Riaz, Z., Arslan, M., Kiani, A. K., & Azhar, S., 2014. CoS-MoS: A BIM and wireless sensor based integrated solution for worker safety in confined spaces. *Automation in Construction*, 45, 96-106.

- Rome, E., Hertzberg, J., Kirchner, F., Licht, U. & Christaller, T. 1999, "Towards autonomous sewer robots: the MAKRO project", *Urban Water*, vol. 1, no. 1, pp. 57-70.
- Ross, B., Bares, J. & Fromme, C. 2003, "A semi-autonomous robot for stripping paint from large vessels", *The International Journal of Robotics Research*, vol. 22, no. 7-8 Special Issue, pp. 617-626.
- Ruz, M. L., Vázquez, F., Salas-Morera, L., & Cubero-Atienza, A. 2012, "Robotic testing of radio frequency devices designed for industrial safety", *Safety science*, vol. 50, no.7, pp. 1606-1617.
- Saaty, T., 1980, *The analytic hierarchy process*. McGraw-Hill, New York.
- Saaty, T., 2000. *Fundamentals of Decision Making and Priority Theory with The Analytic Hierarchy Process*, RWS Publications, Pittsburg
- Saenz, J., Elkmann, N., Stuerze, T., Kutzner, S. & Althoff, H. 2010, "Robotic systems for cleaning and inspection of large concrete pipes", *1st International Conference on Applied Robotics for the Power Industry (CARPI), 2010*, pp. 1.
- Sahli, B.P. & Armstrong, C.W. 1992, "Confined space fatalities in Virginia", *Journal of Occupational Medicine*, vol. 34, no. 9, pp. 910-917.
- Sakamoto, H., Sekine, K., Maeda, M. & Suzuki, H. 2013, "Development of improved AE evaluation technique for corrosion damage in bottom plates of above-ground oil tanks in service", *Journal of the Japan Petroleum Institute*, vol. 56, no. 5, pp. 298-303.
- Sánchez, J., Vázquez, F. & Paz, E. 2006, *Machine Vision Guidance System for a Modular Climbing Robot used in Shipbuilding*, Springer Berlin Heidelberg.
- Savall, J., Avello, A. & Briones, L. 1999, "Two compact robots for remote inspection of hazardous areas in nuclear power plants", *Proceedings - IEEE International Conference on Robotics and Automation*, vol. 3, pp. 1993-1998.
- Schäfer and Urbach 2015a, , *Mobile tank cleaning*. Available: <http://www.schaefer-urbach.com/en/products/tank-cleaning-solutions/mobiletankcleaning/> [2015, Jul].
- Schäfer and Urbach 2015b, , *Modular tank cleaning*. Available: <http://www.schaefer-urbach.com/en/products/tank-cleaning-solutions/modular-tank-cleaning/> [2015, Jul].
- Schäfer and Urbach 2015c, , *Spray cannon*. Available: <http://www.schaefer-urbach.com/en/products/tank-cleaning-solutions/spray-cannon/> [2015, Jul].



- Shang, J., Bridge, B., Sattar, T., Mondal, S. & Brenner, A. 2008, "Development of a climbing robot for inspection of long weld lines", *Industrial Robot*, vol. 35, no. 3, pp. 217-223.
- Singh, S.P., Verma, A. & Shrivastava, A.K. 2008, "Design and development of robotic sewer inspection equipment controlled by embedded systems", *First International Conference on Emerging Trends in Engineering and Technology, 2008. ICETET '08.*, pp. 1317.
- Sipahi, S., & Timor, M., 2010. The analytic hierarchy process and analytic network process: an overview of applications. *Management Decision*, 48(5), 775-808.
- Souto, D., Faiña, A., Deibe, A., Lopez-Peña, F. & Duro, R. 2012, "A robot for the unsupervised grit-blasting of ship hulls", *International Journal of Advanced Robotic Systems*, vol. 9, no. 82, pp. 1-16.
- Strelec, F. 2006, "OSHA compliance issues. Health hazards in a feed mill.", *Journal of Occupational and Environmental Hygiene*, vol. 3, no. 11, pp. D116-D119.
- Summa, V. 2008, "In-service above ground storage tanks inspection robotics technology update", *Inspectioneering Journal*, vol. Mar/Apr, pp. 11-20.
- Sun, E., Zhang, X., & Li, Z., 2012. The internet of things (IOT) and cloud computing (CC) based tailings dam monitoring and pre-alarm system in mines. *Safety science*, 50(4), 811-815.
- SUVA 2013, *Lista di controllo 67103.i. Saldatura, taglio, brasatura e riscaldamento: procedimento a fiamma*, Istituto nazionale svizzero di assicurazione contro gli infortuni, Sicurezza sul lavoro (SUVA).
- SUVA 2012, *Lista di controllo CFSL 6806.i. Fosse d'ispezione e manutenzione*, Istituto nazionale svizzero di assicurazione contro gli infortuni, Sicurezza sul lavoro (SUVA).
- SUVA 2010a, 44040.i *Ambienti di lavoro ristretti: cosa fare contro il pericolo di esplosione, intossicazione e asfissia?*, Istituto nazionale svizzero di assicurazione contro gli infortuni, Sicurezza sul lavoro (SUVA).
- SUVA 2010b, 44062.i *Sicurezza nei lavori all'interno di pozzi, fosse e canalizzazioni*, Istituto nazionale svizzero di assicurazione contro gli infortuni, Sicurezza sul Lavoro (SUVA).
- SUVA 2004, 01416 *Direttive concernenti i lavori all'interno di recipienti e locali stretti*, Istituto Nazionale Svizzero di Assicurazione contro gli Infortuni, Sicurezza sul Lavoro (SUVA).

- Tâche, F., Fischer, W., Caprari, G., Siegart, R., Moser, R. & Mondada, F. 2009, "Magnebike: A magnetic wheeled robot with high mobility for inspecting complex-shaped structures", *Journal of Field Robotics*, vol. 26, no. 5, pp. 453-476.
- Taylor, B. 2011, "Confined Spaces. Common misconceptions & errors in complying with OSHA's standard", *Professional Safety*, vol. July, 2011, pp. 42-46.
- TechCorr 2015a, *Manway Cannons*. Available: <http://techcorr.com/services/Industrial-Services/Manway-Cannons.cfm> [2015, Jul].
- TechCorr 2015b, *Track Driven Robot Unit*. Available: <http://www.techcorr.com/resources/Brochures/ShowBrochure.cfm?docid=66> [2015, Jul].
- TechCorr 2015c, *Short Range Wave Ultrasonic Testing*. Available: <http://www.techcorr.com/short-range-wave-ultrasonic-testing.php> [2015, Jul].
- Tilley, A. R., & Henry Dreyfuss Associates, 2002, "The measure of man and woman: Human factors in design", New York: Wiley.
- Truong-Thinh, N., Ngoc-Phuong, N. & Phuoc-Tho, T. 2011, "A study of pipe-cleaning and inspection robot", *Robotics and Biomimetics (ROBIO), 2011 IEEE International Conference on*, pp. 2593.
- UNI EN 547-1 2009, "Sicurezza del macchinario - Misure del corpo umano - Parte 1: Principi per la determinazione delle dimensioni richieste per le aperture per l'accesso di tutto il corpo nel macchinario".
- UNI EN 547-2 2009, "Sicurezza del macchinario - Misure del corpo umano - Parte 2: Principi per la determinazione delle dimensioni richieste per le aperture di accesso".
- UNI EN 547-3 2009, "Sicurezza del macchinario - Misure del corpo umano - Parte 3: Dati antropometrici".
- UNI EN ISO 7250 2000, "Misurazioni di base del corpo umano per la progettazione tecnologica".
- UNI ISO EN 15537 2005, "Principi per la selezione e l'utilizzo di soggetti di prova per la verifica degli aspetti antropometrici dei prodotti industriali e della loro progettazione".
- UNI ISO EN 15535 2007, "Requisiti generali per la creazione di banche dati di dati antropometrici".

- U.S. Department of Labor 2014, *Confined spaces*. Available:  
<https://www.osha.gov/SLTC/confinedspaces/> [2014, December].
- U.S. Department of Labor, Occupational Safety and Health Administration 2004, *Permit-required Confined Spaces*.
- Walter, C., Saenz, J., Elkmann, N., Althoff, H., Kutzner, S. & Stuerze, T. 2012, "Design considerations of robotic system for cleaning and inspection of large-diameter sewers", *Journal of Field Robotics*, vol. 29, no. 1, pp. 186-214.
- Weimin, S., Gu, J. & Yanjun, S. 2005, "Permanent magnetic system design for the wall-climbing robot", *IEEE International Conference on Mechatronics and Automation, 2005*, pp. 2078.
- Wilson, M.P., Madison, H.N. & Healy, S.B. 2012, "Confined space emergency response: Assessing employer and fire department practices", *Journal of Occupational and Environmental Hygiene*, vol. 9, no. 2, pp. 120.
- Xu, Z. & Ma, P. 2002, "A wall-climbing robot for labelling scale of oil tank's volume", *Robotica*, vol. 20, no. 02, pp. 209-212.
- Yang, L., Yang, S. H., & Plotnick, L., 2013. How the internet of things technology enhances emergency response operations. *Technological Forecasting and Social Change*, 80(9), 1854-1867.
- Ye, C., Ma, S., Li, H. & Yang, J. 2010, *Development of a pipe cleaning robot for air conditioning system*.
- Ye, H. 2011, "Atmosphere Identifying and Testing in Confined Space", *Proceedings of the 2011 First International Conference on Instrumentation, Measurement, Computer, Communication and Control* IEEE Computer Society, Washington, DC, USA, pp. 767.
- Yinghua, Z., Guanghua, F., Zhigang, Z., Zhian, H., Hongchen, L., & Jixing, Y. 2012. Discussion on application of IOT technology in coal mine safety supervision. *Procedia Engineering*, 43, 233-237.
- Zheng, G., Zhu, N., Tian, Z., Chen, Y., & Sun, B., 2012. Application of a trapezoidal fuzzy AHP method for work safety evaluation and early warning rating of hot and humid environments. *Safety Science*, 50(2), 228-239.

Zhu, H., Guan, Y., Wu, W., Zhang, L., Zhou, X. & Zhang, H. 2015, "Autonomous Pose Detection and Alignment of Suction Modules of a Biped Wall-Climbing Robot", *IEEE/ASME Transactions on Mechatronics*, vol. 20, no. 2, pp. 653-662.

# 4 CONCLUSIONS

---

The main purpose of this dissertation is to present the results of a research on innovative models and approaches for Workplace Health and Safety. Following this fundamental idea, several issues are debated and innovative methods are presented, as well as the results of their application on different case studies, from which intermediate and final conclusions are drawn.

Workplace Health and Safety has a broad meaning and embraces a large number of topics related with the integration of the health and safety principles in work environment. According to the hot topics stated by several authors, this research has been focused on the analysis, adaptation, integration, development and application of decision-support methods for the ergonomic design of work (i.e., workplaces, work activities and work organization) and for the improvement of safety in confined spaces.

The first part of this thesis has highlighted the importance of ergonomics in workplaces and the risks of activities in confined spaces. After presenting the results of a survey on current laws and regulations for the two main sub-topics of this thesis (i.e., ergonomics in workplaces and safety in confined spaces), a second survey has focused on available engineering controls for risk management.

As demonstrated by the surveys presented in Chapter 2.1.2 and Chapter 3.1.2, the research on engineering controls has developed several risk control measures to eliminate or reduce the exposure of workers to health risk factors. Furthermore, commercial solutions are available as well, and their potential effectiveness in improving occupational safety has been tested in several industries. Despite the wide availability of risk control measures for the improvement of health and safety conditions in workplaces, statistics and reports show that injuries, fatalities and work-related diseases still occur, causing high costs for workers, companies and for the society. Consequently, the effectiveness of such innovative technologies and commercial solutions is not guaranteed when their proper application in industrial environment is missing.

As results of the survey, this research has analysed risk controls measures for risk management in industry, focusing on the methodologies for their proper introduction in the work environment. According to the hierarchy of controls defined by regulations on occupational safety, two types of risk control methods have been investigated for improving Workplace Health and Safety: engineering and administrative controls.

The first embrace technical solutions and automated machinery that physically change the characteristics of the work environment, acting as a barrier between the workers and the source of the risk. The second control measures include organizational solutions and work procedures for the reduction or the elimination of the exposure of workers to health risk

factors. They include strategies for human resource management (e.g., job rotation), the proper utilisation of tools and equipment and the proper design of the plant layout.

The above-mentioned research topics share the need of appropriate methodologies and approaches for integrating health and safety in workplaces, assessing the impact on the performances of workers and companies, optimising processes and design, and supporting decision-making while planning and managing. Therefore, multi-scenario and sensitivity analysis, linear programming and multi-objective optimisation, have been included in the methodological foundation of the research.

Such methodologies have been adapted and applied (in some cases used for the development of innovative models) for the solving of a large group of process design problems. In the presented industrial applications and case studies, methodologies have often been integrated, taking advantage from their complementarity and facing multidisciplinary and multidimensional problems typical of Workplace Health and Safety.

The research activity has been developed following the research matrix in Figure 4.1. Four different research areas have been identified, as follows:

1. Administrative controls for ergonomics in workplaces;
2. Engineering controls for ergonomics in workplaces;
3. Administrative controls for safety in confined spaces;
4. Engineering controls for safety in confined spaces.

# WORKPLACE HEALTH AND SAFETY

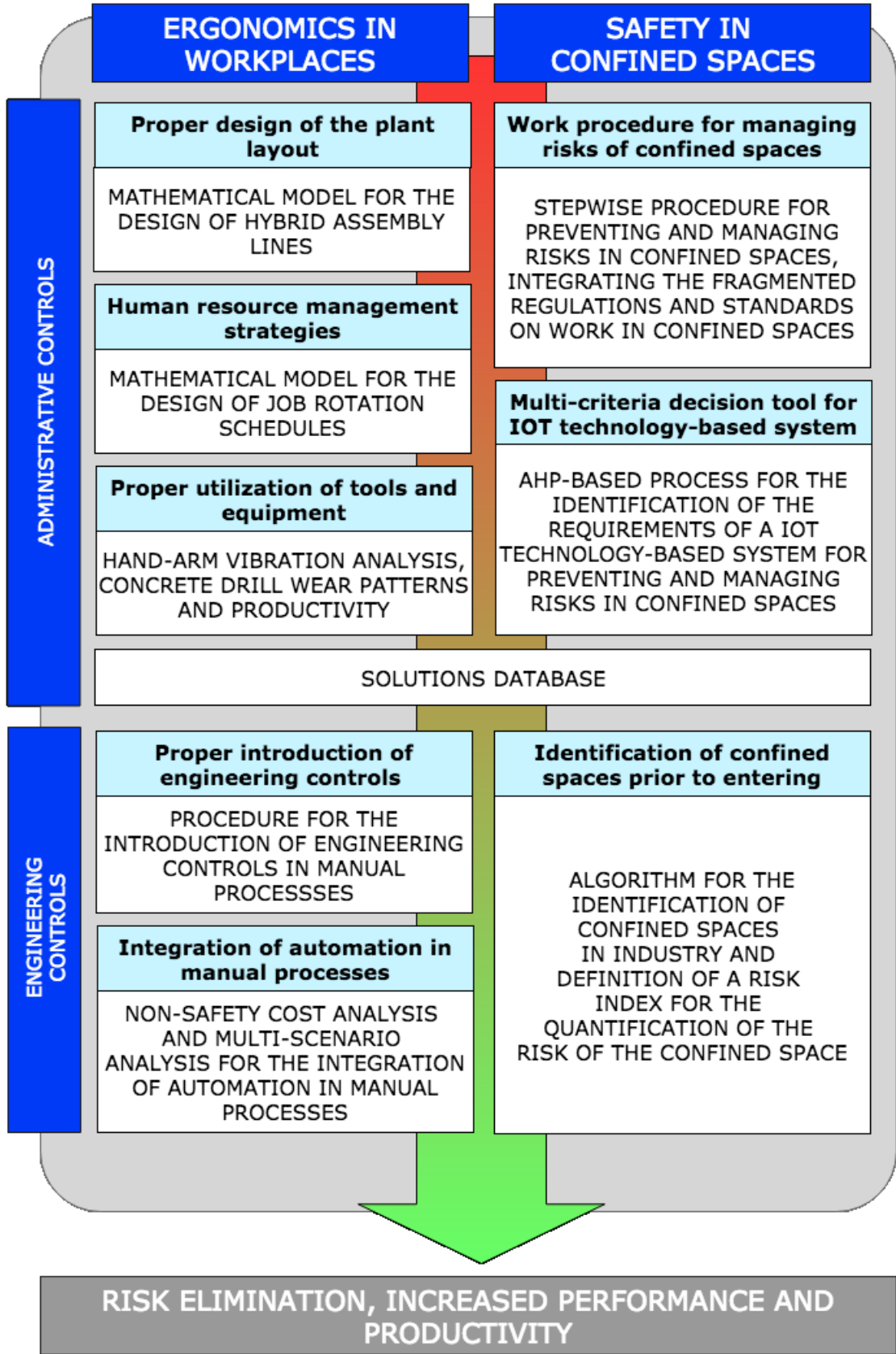

Figure 4.1 Matrix of the research conclusions

The research on administrative controls for ergonomics in workplaces has produced three innovative control measures for the occupational risk reduction. The first is about the proper design of the plant layout integrating the ergonomics principles in a lean manufacturing strategy (Section 2.2.1). Given the production requirements, product characteristics and assembly tasks, the model defines the assembly process for hybrid assembly lines with both manual workers and automated assembly machines. Each assembly line solution ensures an acceptable risk level of repetitive movements, as required by current law. The choice of a different ergonomic risk assessment method might produce different results and have a substantial impact on the design of hybrid assembly lines. Future developments of this work include the adoption of a different ergonomic risk assessment method (e.g., Strain Index) and the analysis of the impact on the solutions of model.

The second administrative control for ergonomics in workplaces is a mathematical model for the design of job rotation schedules in assembly lines (Section 2.2.2). Such control measure adopts job rotation as a measure to minimize the exposure of workers to the risks of repetitive movements and awkward postures, enhancing the rotation between jobs that involve different levels of effort. Similarly to the previous proposed administrative control, each scheduling solution ensures an acceptable risk level of repetitive movements, as required by current law. Future developments of this work include the adoption of a different ergonomic risk assessment method (e.g., Strain Index) to investigate the impact on the solutions of model, and the analysis of the aging workforce phenomenon for the design of job rotation schedules. Older workers are more predisposed to develop WMSD than younger workers because of their decreased functional capacity. The susceptibility for developing WMSD or injury is related to the difference between the demands of work and the worker's ability to perform a demanded activity. A mathematical model for the design of activity schedules for aged workers exposed to the risk of repetitive work will be developed aiming to study the impact of demographic changes on industrial systems.

The third administrative control in Section 2.2.3 aims to reduce the vibration exposure of construction workers while improving their performances through the proper utilization of drilling tools and equipment. Handle vibration was collected during drilling with a 3-axis accelerometer and vibration meter (Section 2.2.3.1). Increasing feed force increased handle vibration levels and productivity up to a force of approximately 170 N beyond which there was little change in vibration levels or productivity. However, the exposure time limit value strongly decreases with the increasing force. Results suggest that the benefit in productivity with high feed force is lower than the benefit in exposure time with low feed force. However, exposure to forceful exertion and vibration may be reduced depending on bit wear. The purpose of the study in Section 2.2.3.2 was to evaluate the relationship between bit wear patterns and drilling productivity (e.g., penetration rate in mm/s) which was measured using a test bench system for hammer drills. Image analysis methods were used to identify thirteen wear parameters from bit images at various stages of wear. Three of the thirteen bit image parameters were strongly related to productivity, (i.e., the size of the angles at the bit



shoulders and the bit width at the height of its shoulders). The findings may have practical value for end users in identifying bits that should be discarded due to reduced cutting ability. The design of a threshold limit bit pattern will be a future development of this study.

The Solutions Database is the result of the state of the art analysis on engineering controls for manual material handling and for safe confined space work. The free online database, funded and developed with the AUSL Bologna, gathers the commercial solutions retrieved during the state of the art analysis.

The review on engineering controls for ergonomics, together with the statistics on the incidence of work-related musculoskeletal disorders in industry, has highlighted a lack of directions and guidelines for the proper introduction of engineering controls in manual processes. The procedure in Section 2.3.1 aims to guide safety personnel and practitioners through the application of engineering controls in manual processes. Two case studies have shown the application of the procedure and its effectiveness in addressing the elimination and the reduction of the exposure of workers to the risk of manual material handling. Finally, the study on the introduction of automated machinery in manual processes has shown the impact of automation on the reduction of the cost of non-safety. Future developments of this study will investigate further applications of the non-safety cost model, based on the cost of injuries and occupational disorders in European health systems.

Chapter 3 has shown the study on administrative and engineering controls for improving safety in confined spaces. The review on world-wide regulations and recent fatalities due to confined space work has revealed that the main cause of accident is the lack of awareness about the presence of the confined area and the risks associated with working in a confined space (Section 3.1.1).

The lack of a common strategy and a shared international standard for addressing the risk of confined space work is the main cause of accidents in confined spaces. The work procedure for managing risks of confined space work in Section 3.2.2 collects the concepts and requirements from the fragmented regulations for safe confined space work. The aim was to provide a reliable tool for the analysis of the dangerous scenario in confined spaces, gathering the fragmented worldwide regulations on confined space work. Based on such procedure, the framework in Section 3.2.2 supports safety managers and risk analysts in choosing or designing the most effective of IOT technology-based system for preventing and managing confined space risks. Section 3.2.3 has proposed an innovative application of the AHP methodology for the design of a multi-criteria decision tool evaluating the potential contribution of IOT technologies to prevent and control the risks of confined space work. Both the framework and the multi-criteria decision tool will be adopted for the design of a IOT technology-based system for preventing and managing risk in confined spaces in the chemical industry.

Future developments of this study will investigate the design of a procedure for the introduction of engineering controls in confined spaces. Finally, the main characteristics of an

engineering control for the risk elimination of activities in confined spaces have been introduced in Section 3.3. The proposed control will consist in an online tool for the identification of confined spaces. The aim is to help workers and practitioners to identify confined spaces and prevent the access of workers into such high-risk areas.

The introduced research highlights the role of workplace health and safety in industry and the potential benefits for employers, employees and society, coming from the application of a well-design strategy on occupational safety and health. The findings of this thesis clearly prove that addressing health and safety in workplaces should not be seen as a regulatory burden, but a lever for the reduction of costs, absenteeism and turnover rates, and to increase productivity and motivation of workers.

# ACKNOWLEDGMENTS

---

The Azienda Unità Sanitaria Locale (AUSL) of Bologna has funded this research. I am grateful for the financial support and for the possibility of working with a supporting and inspiring team of experts and willing people: Villiam Alberghini, Paolo Balboni, Fabiano Bondioli, Marco Broccoli, Simone Capogrossi, Maria Capozzi, Luca Cavallone, Vincenzo D'Elia, Patrizia Ferdenzi, Vito Galante, Alberto Gerosa, Pierluca Gobbi, Giampiero Lucchi, Mauro Maccaferri, Massimo Magnani, Arcangelo Migliore, Gianfranco Tripi, Giorgio Zecchi and Giovanni Andrea Zuccarello.

Thank to Professor David Rempel, Eng. Alan Barr and Prof. Carisa Harris-Adamson for mentoring and stimulating me during my visit at the Department of Bioengineering at University of California in Berkeley, CA, USA. I am grateful to them for their warm welcome in their research group and for sharing with me their researches, competences and experiences.

I want to thank the Industrial Mechanical Plants research group of the Department of Industrial Engineering - Alma Mater Studiorum University of Bologna, and the Department of Management and Engineering of the University of Padua. In particular, I would like to thank Professor Arrigo Pareschi, Professor Emilio Ferrari, Professor Alberto Regattieri, Professor Mauro Gamberi, and Professor Riccardo Manzini for their precious support during my Ph.D. studies.

I would like to express my deepest and sincere gratitude to my Ph.D. supervisor, Professor Cristina Mora, for guiding me through this challenging and stimulating path, acting as a reference point during the past three years. Thank you for your constant encouragement, comprehension and invaluable advices.

I cannot forget to thank my colleagues and friends: Riccardo Accorsi, Giulia Baruffaldi, Marco Bortolini, Alessandro Cascini, Francesco Gabriele Galizia, Alessandro Graziani, Stefano Penazzi, Francesco Piana, Francesco Pilati and Chiara Pini. It has been a pleasure and an honour to share my PhD journey with you all.

Last but not least, I want to thank Federico, my family, and all my close friends for their essential and loving support.

